

Single-chip Type with Built-in FET Switching Regulator Series

High-efficiency Step-up/down Switching Regulators with Built-in Power MOSFET

BD8305MUV

No.09027EBT08

• General Description

ROHM's highly-efficient step-up/down switching regulator BD8305MUV produces step-up/down output including 3.3 V from 1 cell of lithium battery with just one coil.

This IC adopts an original step-up/down drive system and creates a higher efficient power supply than conventional Sepic-system or H-bridge system switching regulators.

• Features

- 1) Highly-efficient step-up/down DC/DC converter to be constructed just with one inductor.
- 2) Input voltage 2.5 V - 5.5 V
- 3) Output current 1 A at 3.3 V
 800 mA at 5.0 V
- 4) Incorporates soft-start function.
- 5) Incorporates timer latch system short protecting function.
- 6) High heat radiation surface mounted package VQFN020V4040

• Application

General portable equipment like portable audio or DSC/DVC

• Operating Conditions (Ta = 25°C)

Parameter	Symbol	Voltage range	Unit
Power supply voltage	Vcc	2.5 to 5.5	V
Output voltage	OUT	2.8 to 5.2	V

• Absolute Maximum Ratings

Parameter	Symbol	BD8305MUV	Unit
Maximum applied power voltage	Vcc,PVCC	7.0	V
Maximum input current	Iinmax	2.0	A
Maximum input voltage	Lx1	7.0	V
	Lx2	7.0	V
Power dissipation	Pd	700	mW
Operating temperature range	Topr	-25 to +85	°C
Storage temperature range	Tstg	-55 to +150	°C
Junction temperature	Tjmax	150	°C

*1 When installed on a 70.0 mm × 70.0 mm × 1.6 mm glass epoxy board. The rating is reduced by 5.6 mW/°C at Ta = 25°C or more.

* These specifications are subject to change without advance notice for modifications and other reasons.

- Electrical Characteristics
(Unless otherwise specified, Ta = 25 °C, VCC = 3.7 V)

Parameter	Symbol	Target Value			Unit	Conditions
		Minimum	Typical	Maximum		
[Low voltage input malfunction preventing circuit]						
Detection threshold voltage	VUV	-	2.25	2.45	V	Vcc monitor
Hysteresis range	ΔVUV_{hy}	50	100	150	mV	
[Oscillator]						
Oscillation frequency	fosc	0.8	1.0	1.2	MHz	RT=47k Ω
[Error AMP]						
INV threshold voltage	VINV	0.790	0.800	0.810	V	
Input bias current	IINV	-50	0	50	nA	Vcc=7.0V , VINV=3.5V
Soft-start time	Tss	0.6	1.00	1.4	msec	RT=47k Ω
Output source current	IEO	10	20	30	μ A	VINV=0.5V , VFB =1.5V
Output sink current	IEI	0.7	1.5	3.0	mA	VINV=1.1V , VFB =1.5V
[PWM comparator]						
LX1 Max Duty	Dmax1	-	-	100	%	
LX2 Max Duty	Dmax2	77	85	93	%	
[Output]						
LX1 PMOS ON resistance	RON1p	-	120	200	m Ω	VGS=3.0V
LX1 NMOS ON resistance	RON1n	-	100	160	m Ω	VGS=3.0V
LX2 PMOS ON resistance	RON2p	-	120	200	m Ω	VGS=3.0V
LX2 NMOS ON resistance	RON2n	-	100	160	M Ω	VGS=3.0V
LX1 OCP threshold	Iocp	1.6	2.4	-	A	PVCC=3.0V
LX1 leak current	I leak1	-1	0	1	μ A	
LX2 leak current	I leak2	-1	0	1	μ A	
[STB]						
STB pin control voltage	Operation	VSTBH	1.5	-	5.5	V
	No-operation	VSTBL	-0.3	-	0.3	V
STB pin pull-down resistance	RSTB	250	400	700	k Ω	
[Circuit current]						
Standby current	VCC pin	ISTB1	-	-	1	μ A
	PVCC pin	ISTB2	-	-	1	μ A
	VOOUT pin	ISTB3	-	-	1	μ A
Circuit current at operation VCC	Icc1	-	500	750	μ A	VINV=1.2V
Circuit current at operation PVCC	Icc2	-	10	20	μ A	VINV=1.2V

• Description of Pins

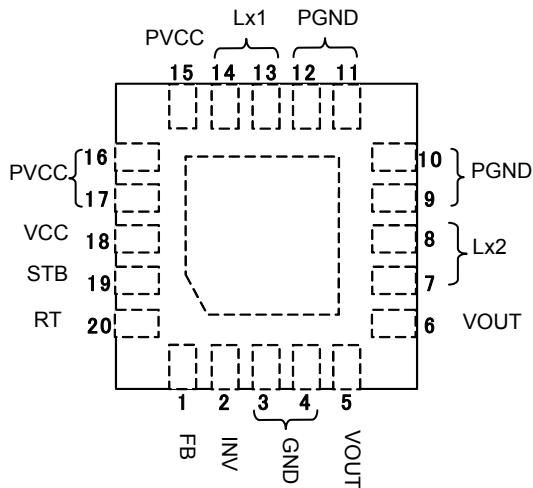

Pin No.	Pin Name	Function
1	FB	Error AMP output terminal
2	INV	Error AMP input terminal
3~4	GND	Ground terminal
5~6	VOUT	Output voltage terminal
7~8	Lx2	Output side coil connecting terminal
9~12	PGND	Power transistor ground terminal
13~14	Lx1	Input side coil connecting terminal
15~17	PVCC	DC/DC converter input terminal
18	VCC	Control part power supply input terminal
19	STB	ON/OFF terminal
20	RT	Oscillation frequency set terminal

Fig. 1 Pin layout

• Block Diagram

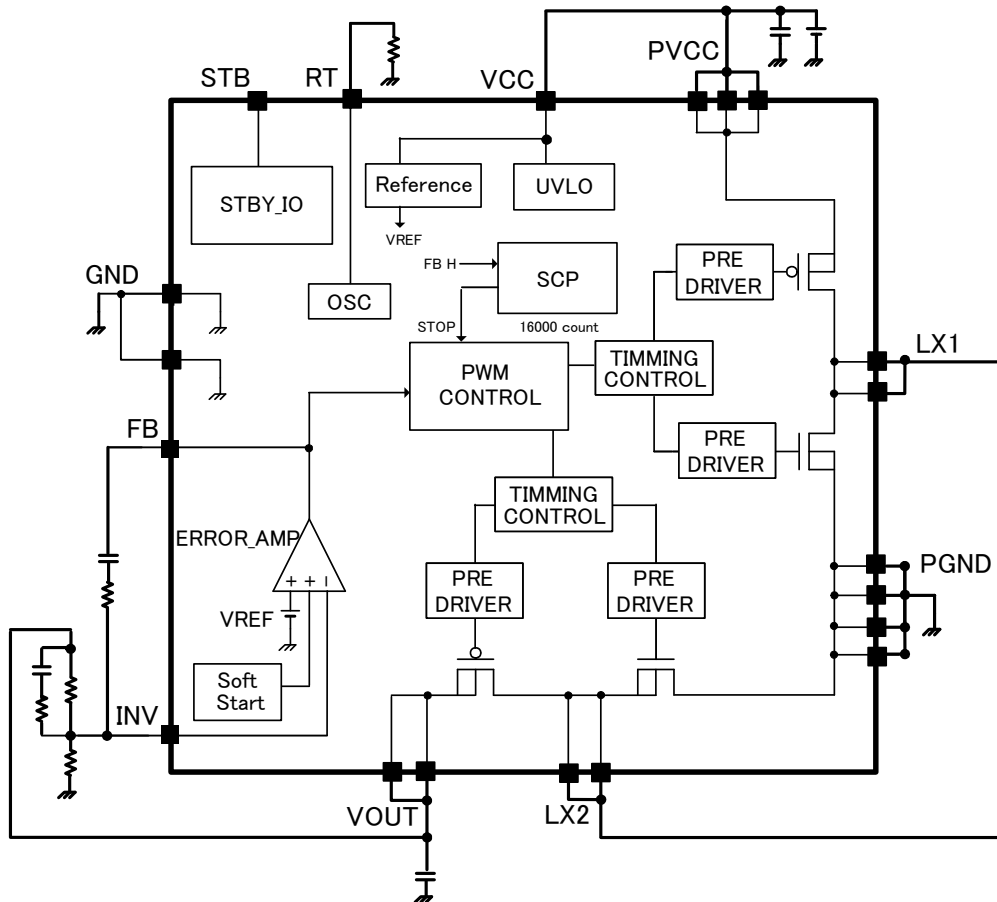

Fig. 2 Block diagram

- Description of Blocks

1. VREF

This block generates ERROR AMP reference voltage.
The reference voltage is 0.8 V.

2. UVLO

Circuit for preventing low voltage malfunction

Prevents malfunction of the internal circuit at activation of the power supply voltage or at low power supply voltage. Monitors VCC pin voltage to turn off all output FET and DC/DC converter output when VCC voltage is lower than 2.2 V, and reset the timer latch of the internal SCP circuit and soft-start circuit.

3. SCP

Timer latch system short-circuit protection circuit

When the INV pin is the set 0.8 V or lower voltage, the internal SCP circuit starts counting.

The internal counter is in synch with OSC, the latch circuit activates after the counter counts about 8200 oscillations to turn off DC/DC converter output (about 8.2 msec when $RT = 47k\Omega$).

To reset the latch circuit, turn off the STB pin once. Then, turn it on again or turn on the power supply voltage again.

4. OSC

Oscillation circuit to change frequency by external resistance of the RT pin (20 pin).

When $RT = 47 k\Omega$, operation frequency is set at 1 MHz.

5. ERROR AMP

Error amplifier for detecting output signals and output PWM control signals

The internal reference voltage is set at 0.8 V.

6. PWM COMP

Voltage-pulse width converter for controlling output voltage corresponding to input voltage

Comparing the internal SLOPE waveform with the ERROR AMP output voltage, PWM COMP controls the pulse width and outputs to the driver.

Max Duty and Min Duty are set at the primary side and the secondary side of the inductor respectively, which are as follows:

Primary side (Lx1)	Max Duty : 100 %,
	Min Duty : 0 %
Secondary side (Lx2)	Max Duty : 100 %,
	Min Duty : About 15 %

7. SOFT START

Circuit for preventing in-rush current at startup by bringing the output voltage of the DC/DC converter into a soft-start

Soft-start time is in synch with the internal OSC, and the output voltage of the DC/DC converter reaches the set voltage after about 1000 oscillations (About 1 msec when $RT = 47 k\Omega$).

8. PRE DRIVER

CMOS inverter circuit for driving the built-in Pch/Nch FET

Dead time is provided for preventing feedthrough during switching.

The dead time is set at about 15 nsec for each individual SWs.

9. STBY_IO

Voltage applied on STB pin (19 pin) to control ON/OFF of IC

Turned ON when a voltage of 1.5 V or higher is applied and turned OFF when the terminal is open or 0 V is applied.

Incorporates approximately 400 k Ω pull-down resistance.

10. Pch/Nch FET SW

Built-in SW for switching the coil current of the DC/DC converter. Pch FET is about 120m Ω and Nch is 100m Ω .

Since the current rating of this FET is 2A, it should be used within 1.6A in total including the DC current and ripple current of the coil.

- Reference Data
(Unless otherwise specified, Ta = 25°C, VCC = 3.7 V)

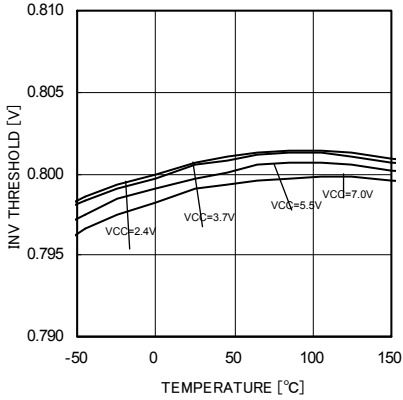

Fig.3 INV threshold

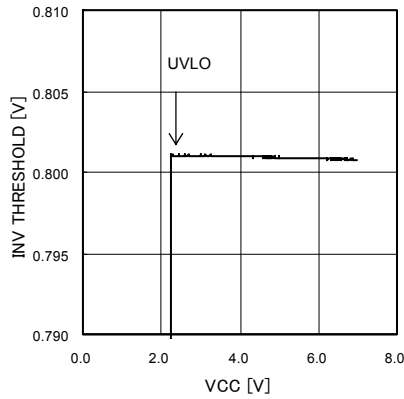

Fig.4 INV threshold (power supply property)

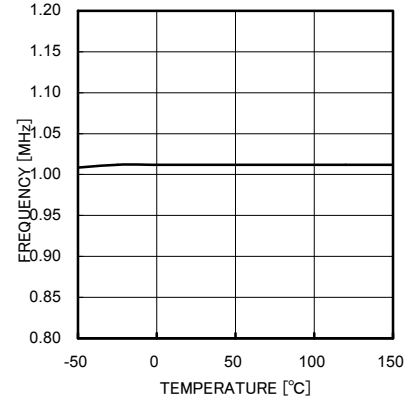

Fig.5 Oscillation frequency

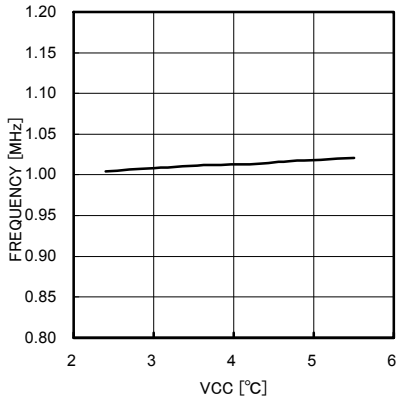

Fig.6 Oscillation frequency (power supply property)

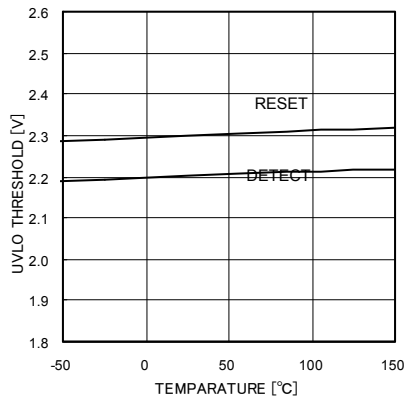

Fig.7 UVLO threshold

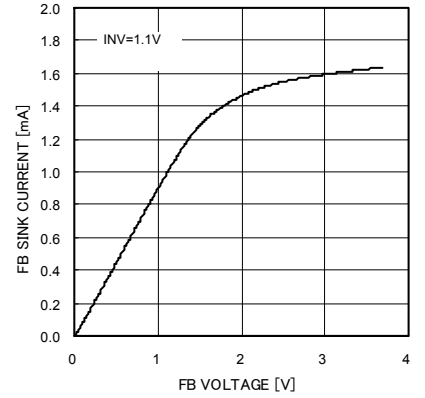

Fig.8 FB sink current

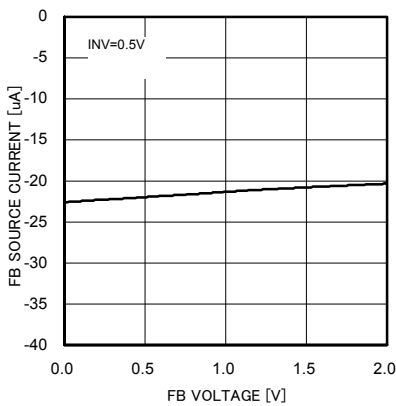

Fig.9 FB source current

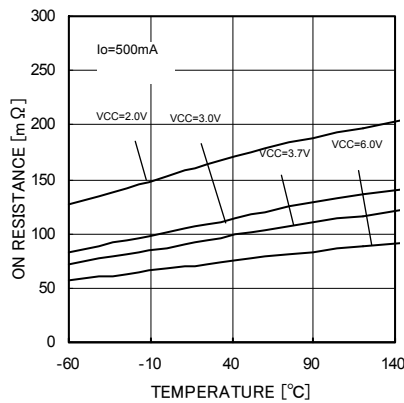

Fig.10 Lx1 Pch FET ON resistance

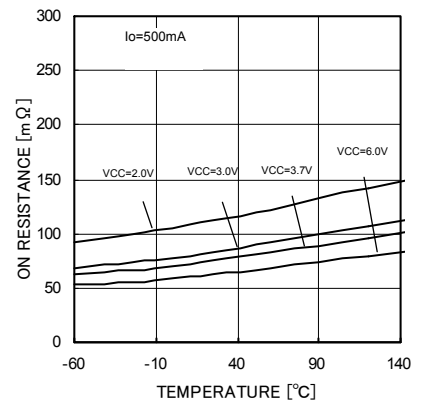

Fig.11 Lx1 Nch FET ON resistance

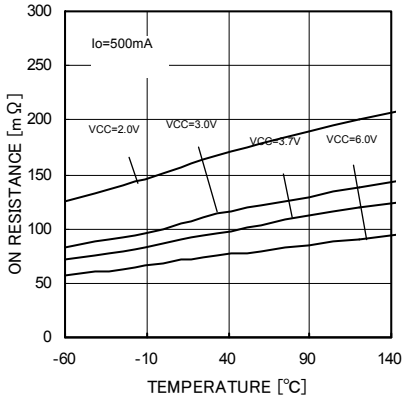

Fig.12 Lx2 Pch FET ON resistance

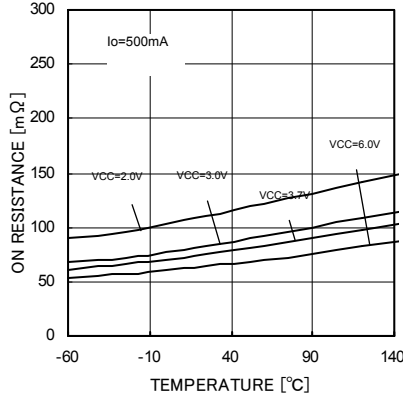

Fig.13 Lx2 Nch FET ON resistance

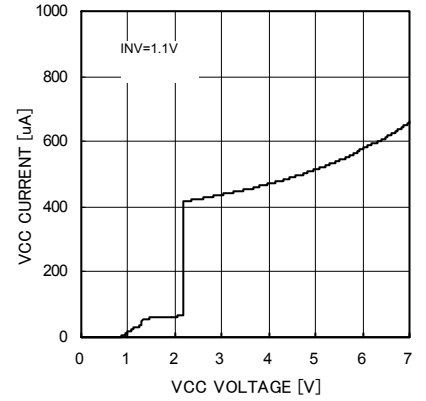

Fig.14 VCC input current

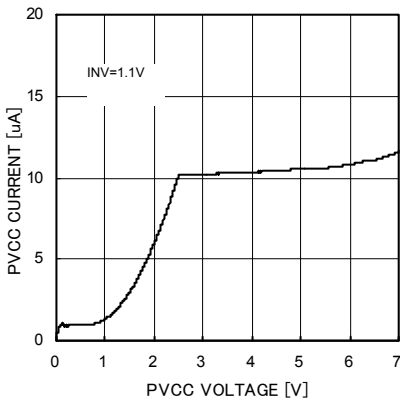

Fig.15 PVCC input current

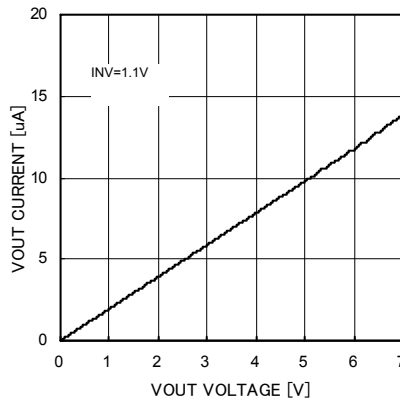

Fig.16 VOUT input current

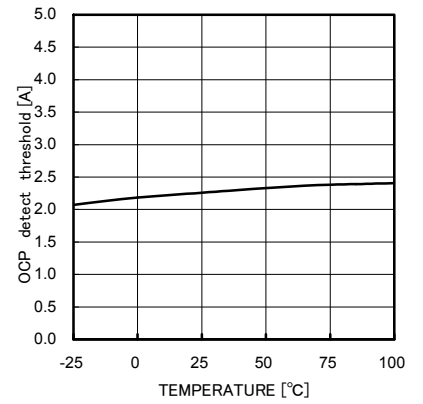

Fig.17 OCP detect threshold -Ta

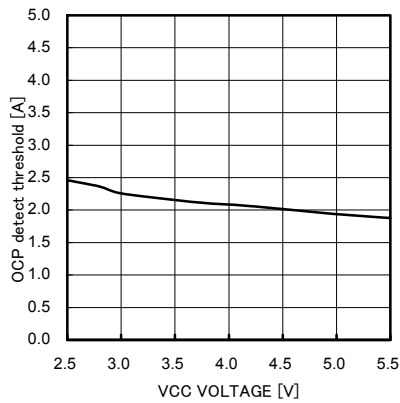

Fig.18 OCP detect threshold -VCC

• Example of Board Layout

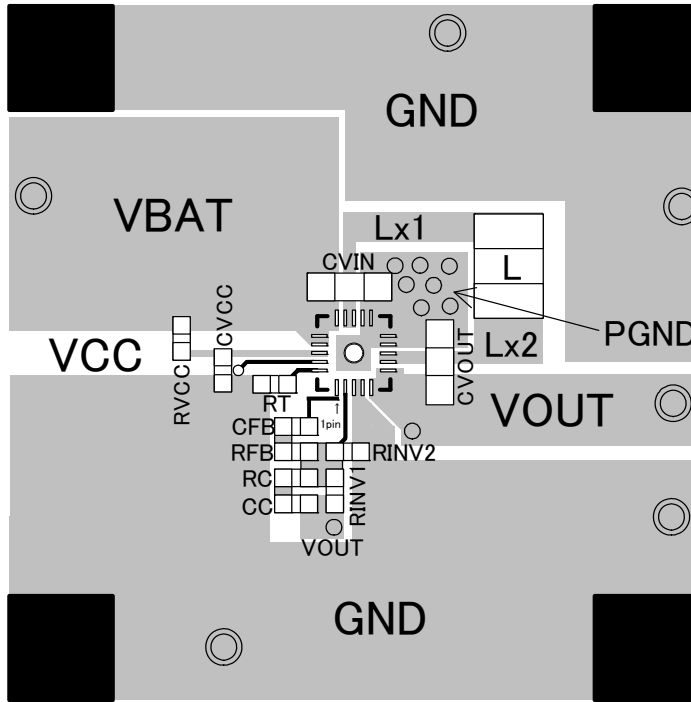

Fig.21 Example of Board Layout

• Reference Application Data
(Example of application 1)

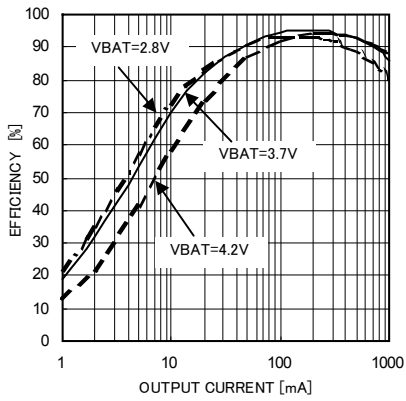

Fig.22 Power conversion efficiency

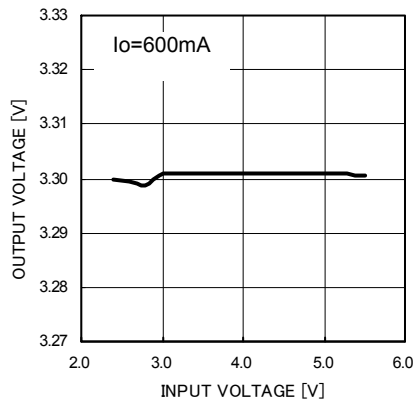

Fig.23 Line regulation

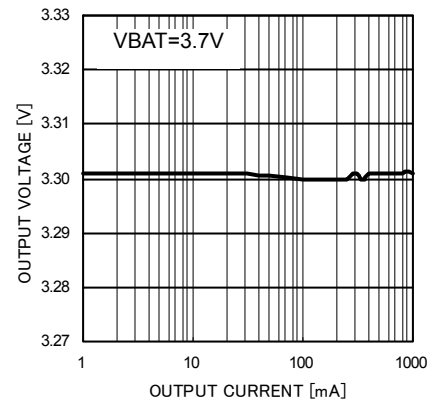

Fig.24 Load regulation

• (Example of application2)

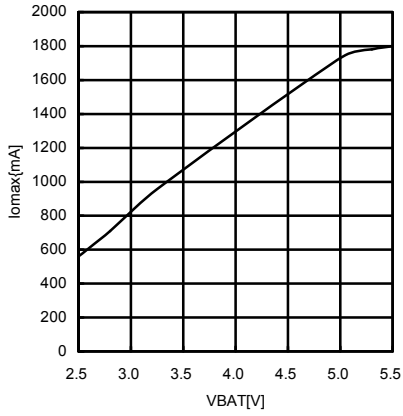

Fig.25 Maximum output current

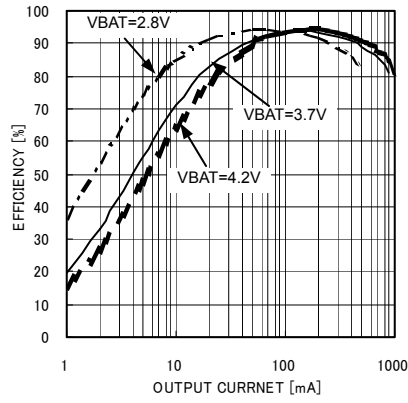

Fig.26 Power conversion efficiency

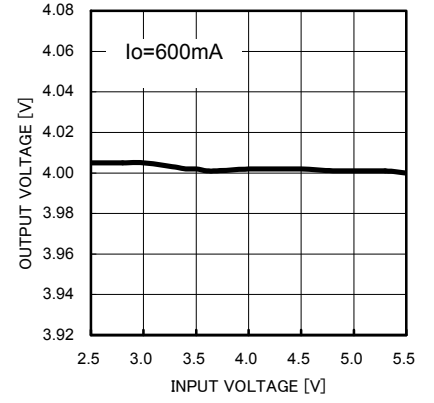

Fig.27 Line regulation

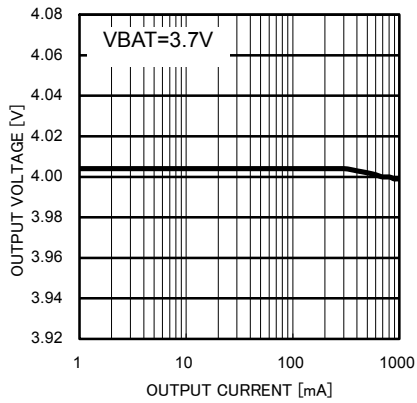

Fig.28 Load regulation

• Selection of Parts for Applications

(1) Output inductor

A shielded inductor that satisfies the current rating (current value, I_{peak} as shown in the drawing below) and has a low DCR (direct current resistance component) is recommended.

Inductor values affect output ripple current greatly.

Ripple current can be reduced as the coil L value becomes larger and the switching frequency becomes higher as the equations shown below.

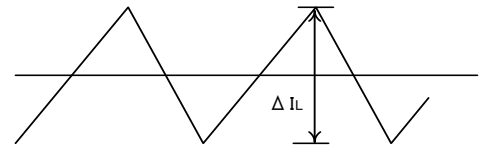

Fig. 29 Ripple current

$$I_{peak} = I_{out} \times (V_{out}/V_{in}) / \eta + \Delta I_L / 2 \text{ [A]} \quad (1)$$

$$\Delta I_L = \frac{(V_{in} - V_{out})}{L} \times \frac{V_{out}}{V_{in}} \times \frac{1}{f} \text{ [A]} \text{ (in step-down mode)} \quad (2)$$

$$\Delta I_L = \frac{|(V_{in} - V_{out})|}{L} \times \frac{V_{out} \times 2 \times 0.85}{(V_{in} + V_{out})} \times \frac{1}{f} \text{ [A]} \text{ (in step-up/down mode)} \quad (3)$$

$$\Delta I_L = \frac{(V_{out} - V_{in})}{L} \times \frac{V_{in}}{V_{out}} \times \frac{1}{f} \text{ [A]} \text{ (in step-up mode)} \quad (4)$$

(η: Efficiency, ΔIL: Output ripple current, f: Switching frequency)

As a guide, output ripple current should be set at about 20 to 50% of the maximum output current.

* Current over the coil rating flowing in the coil brings the coil into magnetic saturation, which may lead to lower efficiency or output oscillation. Select an inductor with an adequate margin so that the peak current does not exceed the rated current of the coil.

(2) Output capacitor

A ceramic capacitor with low ESR is recommended for output in order to reduce output ripple.

There must be an adequate margin between the maximum rating and output voltage of the capacitor, taking the DC bias property into consideration.

Output ripple voltage when ceramic capacitor is used is obtained by the following equation.

$$V_{pp} = \Delta I_L \times \frac{1}{2\pi \times f \times C_o} + \Delta I_L \times R_{ESR} \text{ [V]} \dots (5)$$

Setting must be performed so that output ripple is within the allowable ripple voltage.

(3) Setting of oscillation frequency

Oscillation frequency can be set using a resistance value connected to the RT pin (1 pin).

Oscillation frequency is set at 1 MHz when RT = 47 kΩ, and frequency is inversely proportional to RT value.

See Fig. 30 for the relationship between RT and frequency.

Soft-start time changes along with oscillation frequency.

See Fig. 31 for the relationship between RT and soft-start time.

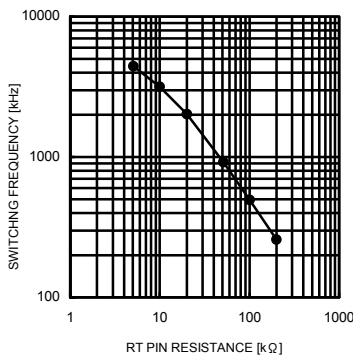

Fig. 30 Oscillation frequency – RT pin resistance

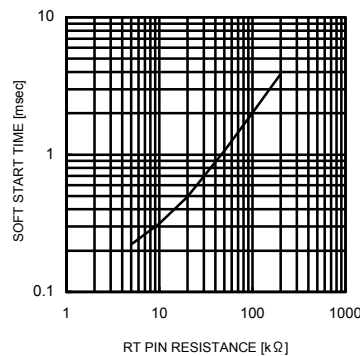

Fig. 31 Soft-start time – RT pin resistance

* Note that the above example of frequency setting is just a design target value, and may differ from the actual equipment.

(4) Output voltage setting

The internal reference voltage of the ERROR AMP is 0.8 V. Output voltage should be obtained by referring to Equation (8) of Fig.32.

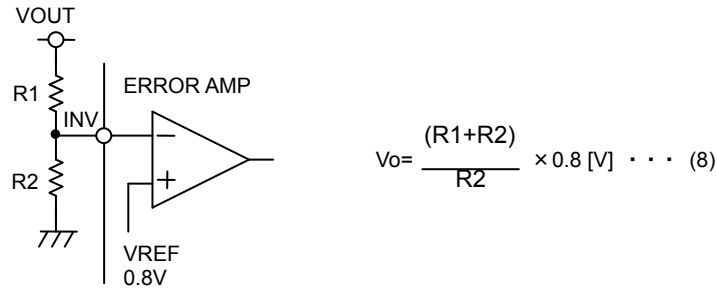

Fig. 32 Setting of feedback resistance

(5) Determination of phase compensation

Condition for stable application

The condition for feedback system stability under negative feedback is as follows:

- Phase delay is 135 ° or less when gain is 1 (0 dB) (Phase margin is 45° or higher)

Since DC/DC converter application is sampled according to the switching frequency, the GBW of the whole system (frequency at which gain is 0 dB) must be set to be equal to or lower than 1/5 of the switching frequency. In summary, target property of applications is as follows:

- Phase delay must be 135° or lower when gain is 1 (0 dB) (Phase margin is 45° or higher).
- The GBW at that time (frequency when gain is 0 dB) must be equal to or lower than 1/5 of the switching frequency.

For this reason, switching frequency must be increased to improve responsiveness.

One of the points to secure stability by phase compensation is to cancel secondary phase delay (-180°) generated by LC resonance by the secondary phase lead (i.e. put two phase leads).

Since GBW is determined by the phase compensation capacitor attached to the error amplifier, when it is necessary to reduce GBW, the capacitor should be made larger.

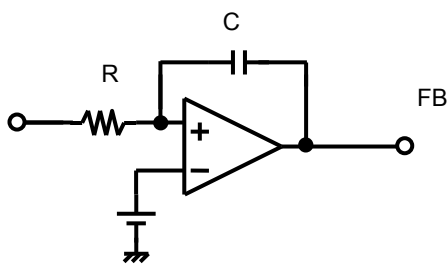

Fig.33 General integrator

Error AMP is a low-pass filter because phase compensation such as (1) and (2) is performed. For DC/DC converter application, R is a parallel feedback resistance.

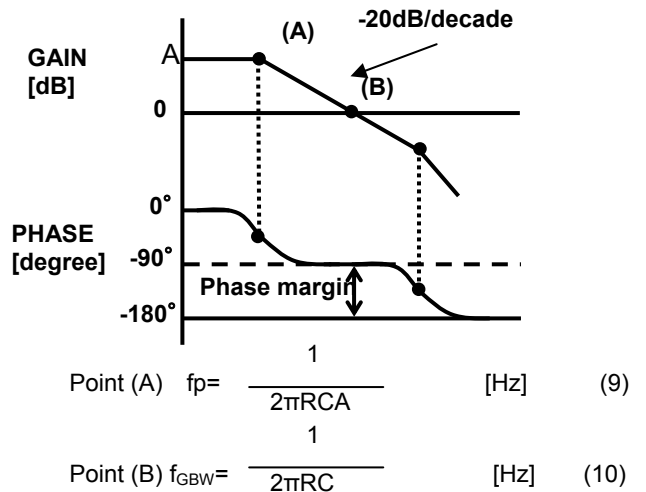

Fig.34 Frequency property of integrator

Phase compensation when output capacitor with low ESR such as ceramic capacitor is used is as follows:

When output capacitor with low ESR (several tens of mΩ) is used for output, secondary phase lead (two phase leads) must be put to cancel secondary phase lead caused by LC.

One of the examples of phase compensation methods is as follows:

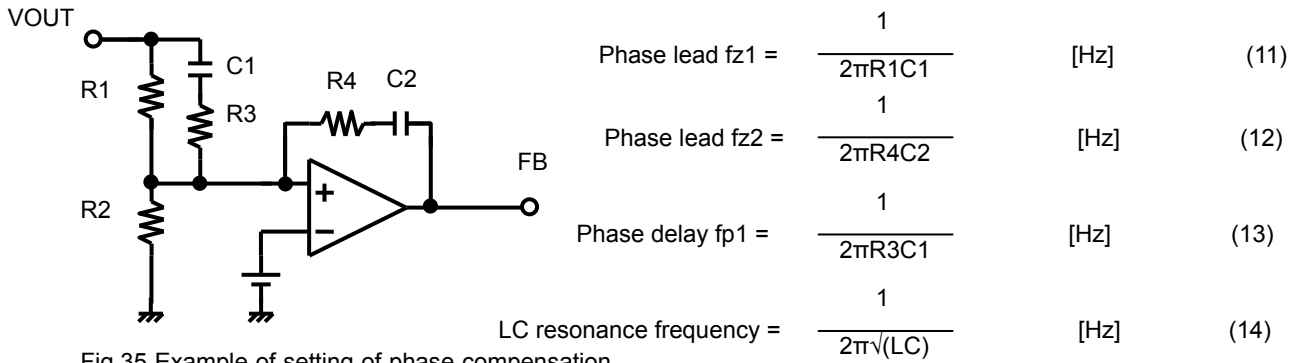

Fig.35 Example of setting of phase compensation

For setting of phase-lead frequency, both of them should be put near LC resonance frequency.
 When GBW frequency becomes too high due to the secondary phase lead, it may get stabilized by setting the primary phase delay to a frequency slightly higher than the LC resonance frequency by R3 to compensate it.

• I/O Equivalence Circuit

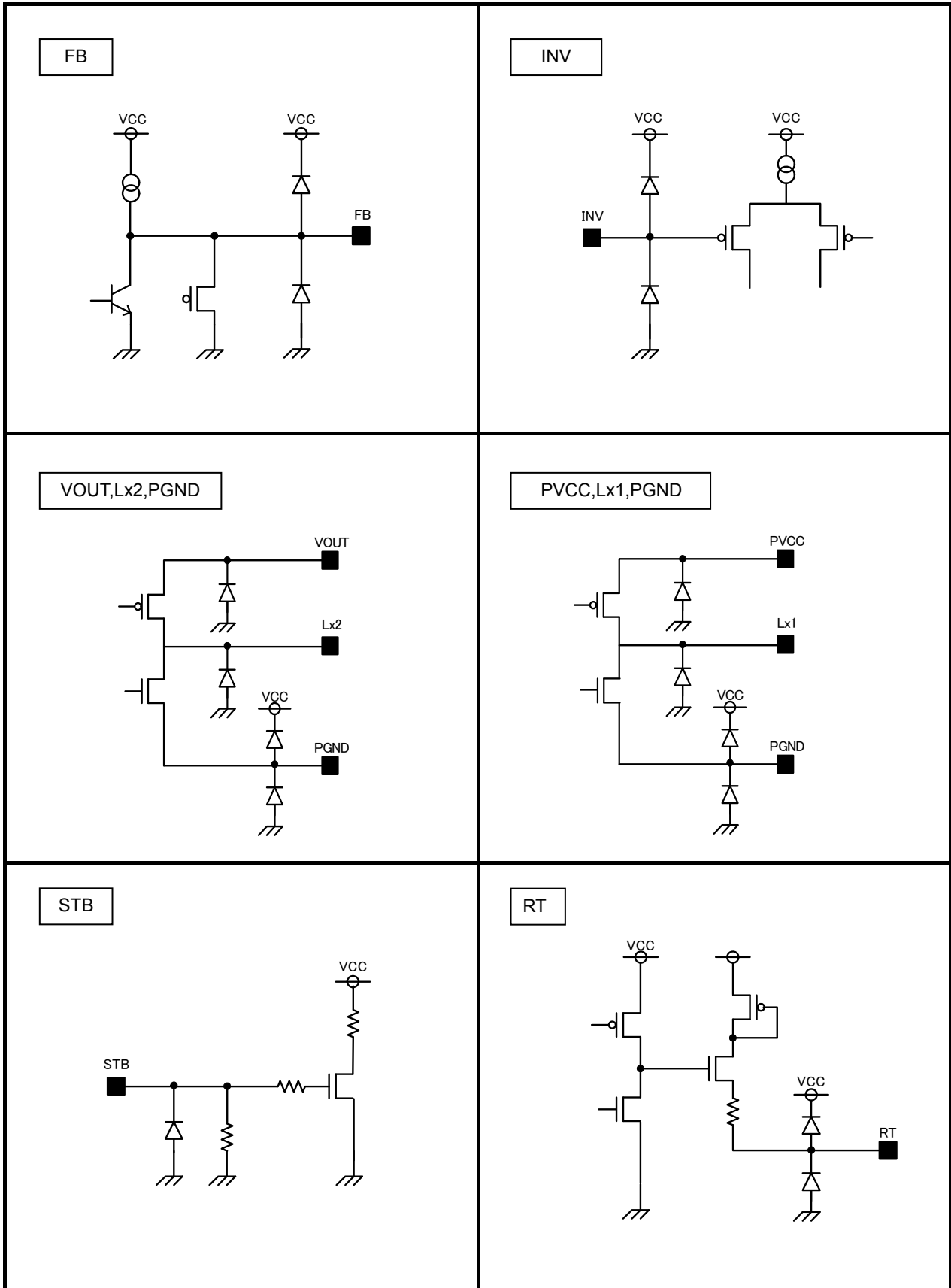

Fig.36 I/O Equivalence Circuit

● Precautions for Use

1) Absolute Maximum Rating

We dedicate much attention to the quality control of these products, however the possibility of deterioration or destruction exists if the impressed voltage, operating temperature range, etc., exceed the absolute maximum ratings. In addition, it is impossible to predict all destructive situations such as short-circuit modes, open circuit modes, etc. If a special mode exceeding the absolute maximum rating is expected, please review matters and provide physical safety means such as fuses, etc.

2) GND Potential

Keep the potential of the GND pin below the minimum potential at all times.

3) Thermal Design

Work out the thermal design with sufficient margin taking power dissipation (P_d) in the actual operation condition into account.

4) Short Circuit between Pins and Incorrect Mounting

Attention to IC direction or displacement is required when installing the IC on a PCB. If the IC is installed in the wrong way, it may break. Also, the threat of destruction from short-circuits exists if foreign matter invades between outputs or the output and GND of the power supply.

5) Operation under Strong Electromagnetic Field

Be careful of possible malfunctions under strong electromagnetic fields.

6) Common Impedance

When providing a power supply and GND wirings, show sufficient consideration for lowering common impedance and reducing ripple (i.e., using thick short wiring, cutting ripple down by LC, etc.) as much as you can.

7) Thermal Protection Circuit (TSD Circuit)

This IC contains a thermal protection circuit (TSD circuit). The TSD circuit serves to shut off the IC from thermal runaway and does not aim to protect or assure operation of the IC itself. Therefore, do not use the TSD circuit for continuous use or operation after the circuit has tripped.

8) Rush Current at the Time of Power Activation

Be careful of the power supply coupling capacity and the width of the power supply and GND pattern wiring and routing since rush current flows instantaneously at the time of power activation in the case of CMOS IC or ICs with multiple power supplies.

9) IC Terminal Input

This is a monolithic IC and has P+ isolation and a P substrate for element isolation between each element. P-N junctions are formed and various parasitic elements are configured using these P layers and N layers of the individual elements.

For example, if a resistor and transistor are connected to a terminal as shown on Fig.37:

- The P-N junction operates as a parasitic diode when $GND > (Terminal A)$ in the case of a resistor or when $GND > (Pin B)$ in the case of a transistor (NPN)

- Also, a parasitic NPN transistor operates using the N layer of another element adjacent to the previous diode in the case of a transistor (NPN) when $GND > (Pin B)$.

The parasitic element consequently rises under the potential relationship because of the IC's structure. The parasitic element pulls interference that could cause malfunctions or destruction out of the circuit. Therefore, use caution to avoid the operation of parasitic elements caused by applying voltage to an input terminal lower than the GND (P board), etc.

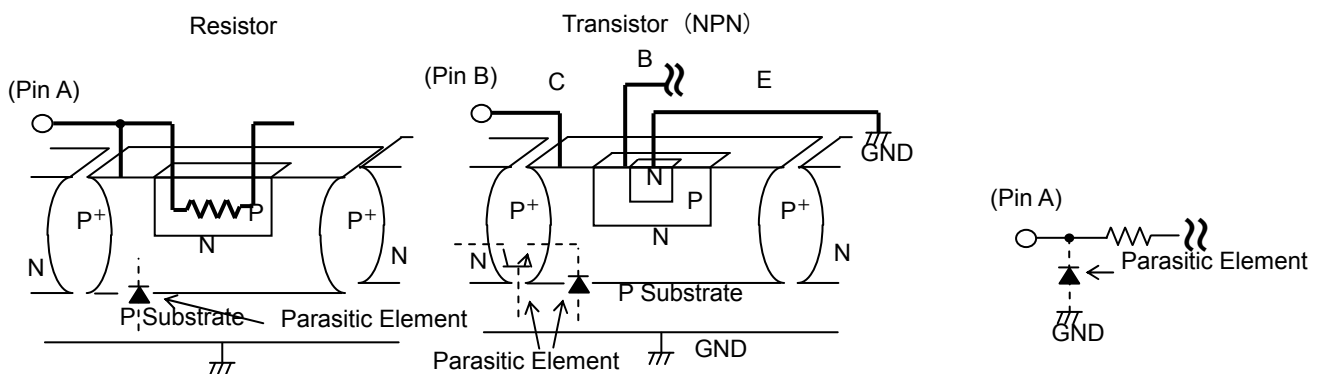

Fig.37 Example of simple structure of Bipolar IC

● Ordering part number

B	D
---	---

Part No.

8	3	0	5
---	---	---	---

Part No.

M	U	V
---	---	---

Package
MUV: VQFN020V4040

-	E	2
---	---	---

Packaging and forming specification
E2: Embossed tape and reel

VQFN020V4040

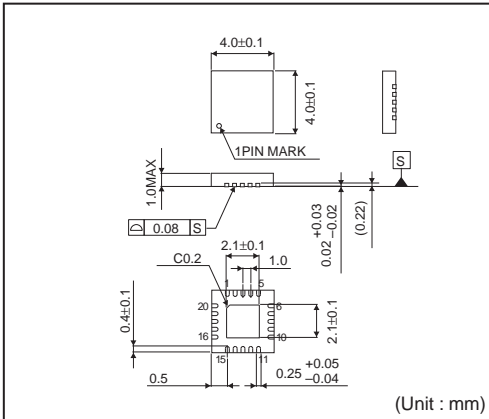

<Tape and Reel information>

Tape	Embossed carrier tape
Quantity	2500pcs
Direction of feed	E2 (The direction is the 1pin of product is at the upper left when you hold reel on the left hand and you pull out the tape on the right hand)

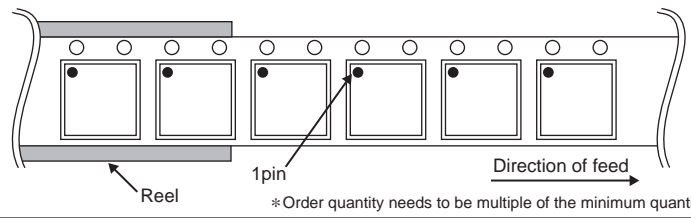

Notes

No copying or reproduction of this document, in part or in whole, is permitted without the consent of ROHM Co.,Ltd.

The content specified herein is subject to change for improvement without notice.

The content specified herein is for the purpose of introducing ROHM's products (hereinafter "Products"). If you wish to use any such Product, please be sure to refer to the specifications, which can be obtained from ROHM upon request.

Examples of application circuits, circuit constants and any other information contained herein illustrate the standard usage and operations of the Products. The peripheral conditions must be taken into account when designing circuits for mass production.

Great care was taken in ensuring the accuracy of the information specified in this document. However, should you incur any damage arising from any inaccuracy or misprint of such information, ROHM shall bear no responsibility for such damage.

The technical information specified herein is intended only to show the typical functions of and examples of application circuits for the Products. ROHM does not grant you, explicitly or implicitly, any license to use or exercise intellectual property or other rights held by ROHM and other parties. ROHM shall bear no responsibility whatsoever for any dispute arising from the use of such technical information.

The Products specified in this document are intended to be used with general-use electronic equipment or devices (such as audio visual equipment, office-automation equipment, communication devices, electronic appliances and amusement devices).

The Products specified in this document are not designed to be radiation tolerant.

While ROHM always makes efforts to enhance the quality and reliability of its Products, a Product may fail or malfunction for a variety of reasons.

Please be sure to implement in your equipment using the Products safety measures to guard against the possibility of physical injury, fire or any other damage caused in the event of the failure of any Product, such as derating, redundancy, fire control and fail-safe designs. ROHM shall bear no responsibility whatsoever for your use of any Product outside of the prescribed scope or not in accordance with the instruction manual.

The Products are not designed or manufactured to be used with any equipment, device or system which requires an extremely high level of reliability the failure or malfunction of which may result in a direct threat to human life or create a risk of human injury (such as a medical instrument, transportation equipment, aerospace machinery, nuclear-reactor controller, fuel-controller or other safety device). ROHM shall bear no responsibility in any way for use of any of the Products for the above special purposes. If a Product is intended to be used for any such special purpose, please contact a ROHM sales representative before purchasing.

If you intend to export or ship overseas any Product or technology specified herein that may be controlled under the Foreign Exchange and the Foreign Trade Law, you will be required to obtain a license or permit under the Law.



Thank you for your accessing to ROHM product informations.
More detail product informations and catalogs are available, please contact us.

ROHM Customer Support System

<http://www.rohm.com/contact/>