



Basic Board Mount Pressure Sensors

TBP Series, Compensated/Unamplified

60 mbar to 10 bar | 6 kPa to 1 MPa | 1 psi to 150 psi
Millivolt Analog Output



Basic Board Mount Pressure Sensors

Honeywell's Basic Board Mount Pressure Sensors, TBP Series, Compensated/Unamplified, are piezoresistive silicon pressure sensors designed for customers who require a simple, high quality, cost-effective, mV output, unamplified, temperature-compensated sensor for use in medical and industrial applications.

These unamplified and temperature-compensated sensors offer infinite resolution of the pressure signal. They will operate as specified from -40 °C to 125 °C [-40 °F to 257 °F].

The TBP Series is often ideal for those customers who want to do their own amplification in order to make use of the maximum resolution of the bare sensor output, leveraging any algorithm needed for the application.

They are available with several package styles and mounting options, making it easier for device manufacturers to integrate the product into their applications.

The TBP Series measures gage pressures. Gage pressure sensors are referenced to atmospheric pressure and provide an output proportional to pressure variations from atmosphere.

They are intended for use with non-corrosive, non-ionic gases, such as air and other dry gases, and for non-corrosive, non-ionic liquids when the silicone gel coating option is selected. All products are designed and manufactured according to ISO 9001.

Why choose a Honeywell Basic Pressure Sensor?

- **Cost-effective:** Provides a cost-effective, high-volume solution with a variety of options
- **Compensated, unamplified:** Ideal for customers who want a temperature-compensated sensor with the maximum possible resolution
- **Flexible:** Package and pressure port options simplify integration into the application
- **Durable:** Wide operating temperature range and media compatibility options
- **High quality:** Six Sigma standards provide the highest level of product quality, performance, and consistency
- **Reliable:** Dependable supply chain is there throughout your development cycle
- **Delivery:** Fast response to orders and sample requests

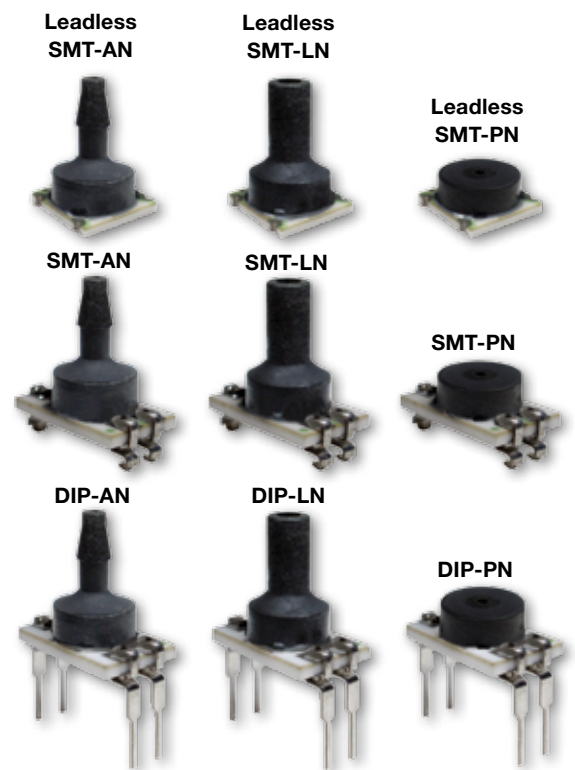

COST EFFECTIVE • DURABLE • HIGH QUALITY

Features and Benefits

Cost-effective sensing solution.

COST-EFFECTIVE SENSORS WITH MANY OPTIONS

Helps customers to meet their specific application needs.

Frees up PCB space, reduces costs.

SMALL PACKAGE SIZE

7 mm x 7 mm [0.276 in x 0.276 in], which is very small when compared to most board mount pressure sensors, occupying less space on the PCB (printed circuit board) and typically allowing for easy placement on crowded PCBs or in small devices.

Performs in tough environments with wet and dry media.

WIDE OPERATING TEMPERATURE RANGE OF -40 °C TO 125 °C [-40 °F TO 257 °F]

Allows for use in many applications

MEDIA COMPATIBILITY OPTIONS:

- **No gel coating:** The input port is limited to non-corrosive, non-ionic media such as dry air and gases and should not be exposed to condensation. The gases are limited to media that are compatible with high temperature polyamide, silicone, alumina ceramic, silicon, gold, and glass.
- **Silicone gel coating:** Uses the same materials in the wetted media path but is protected from condensation by a silicone-based gel coating; allows use in applications where condensation can occur.

ROHS AND ISO 9001 COMPLIANCE

Flexibility simplifies integration.

MANY PACKAGE STYLES, PRESSURE RANGES, SILICONE GEL COATING AND PORTING OPTIONS

Simplifies integration into the device manufacturer's application.

Features and Benefits

SUPPORTS LEAN MANUFACTURING

- J-STD-020-D MSL 1 unlimited shelf life after packaging is opened.
- System can be calibrated within one hour after reflow solder.
- Compatible with modern lead-free and no-clean solder processes.

Honeywell—the gold standard of quality and value.

MANUFACTURING EXCELLENCE

Honeywell has more than 100 years of manufacturing and engineering excellence.

FAST REQUEST FOR QUOTES (RFQS)

Responding quickly to your RFQs and product sample needs are hallmarks of Honeywell.

FAST RESPONSE FOR SAMPLES

Dedicated teams and manufacturing processes help ensure that product samples are shipped quickly and delivered in time to support your development cycle.

RELIABLE SUPPLY CHAIN

Honeywell's effective inventory management and dependable supply chain are there throughout your product life cycle.

DESIGNED TO SIX SIGMA STANDARDS

Six Sigma standards provide the highest level of product quality, performance and consistency. Six Sigma provides confidence that the sensor will perform to specification. Many competitive products are produced to lower Sigma tolerances, which may result in some products not performing to the specification to which they were designed.

SUPPORTING DOCUMENTATION

Honeywell's website provides technical materials to assist you in your application needs.

Potential Applications



MEDICAL

- HOSPITAL BEDS
- OXYGEN CONCENTRATORS
- WOUND THERAPY
- BLOOD PRESSURE MONITORING



INDUSTRIAL

- HVAC TRANSMITTERS
- AIR MOVEMENT CONTROL
- ENVIRONMENTAL CONTROL
- LEAK DETECTION
- INDUSTRIAL CONTROLS
- PNEUMATIC CONTROLS
- OTHER COMMERCIAL APPLICATIONS



TBP Series, Compensated/Unamplified

Figure 1. Nomenclature and Order Guide

For example, **TBPDANN150PGUCV** defines a TBP Series Basic Board Mount Pressure Sensor, DIP package, AN pressure port, without gel coating in media path, 150 psi gage pressure range, unamplified, compensated, constant supply voltage.

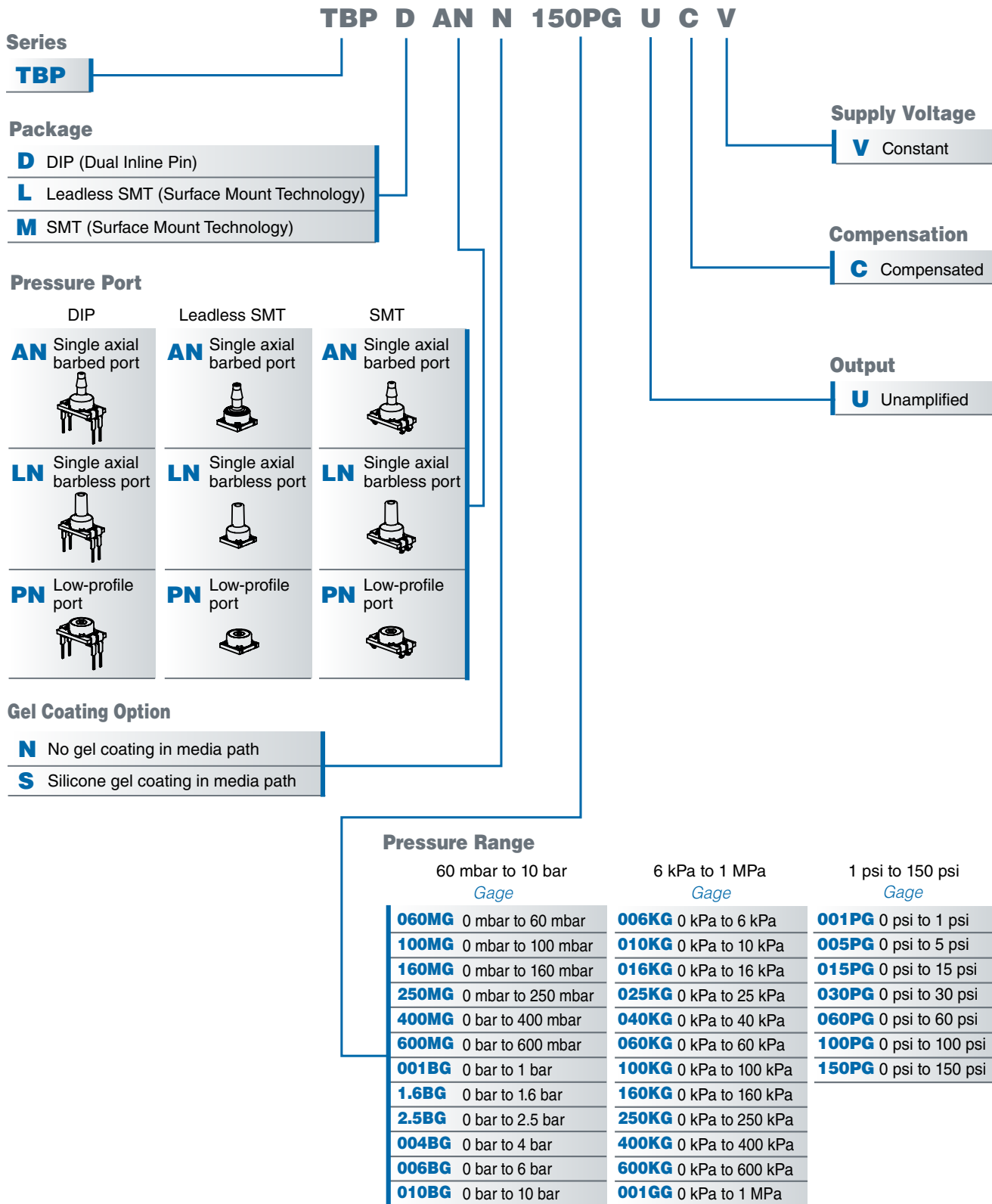

Basic Board Mount Pressure Sensors

Table 1. Absolute Maximum Ratings¹

Characteristic	Min.	Max.	Unit
Supply voltage (V_{supply}) ²	-12.0	12.0	Vdc
Storage temperature	-40 [-40]	125 [257]	°C [°F]
Soldering time and temperature: lead solder temperature (DIP) peak reflow temperature (Leadless SMT, SMT)		4 s max. at 250 °C [482 °F] 15 s max. at 250 °C [482 °F]	

¹Absolute maximum ratings are the extreme limits the device will withstand without damage.

²Incorrect application of supply voltage or ground to the wrong pin may cause electrical failure.

Table 2. Operating Specifications

Characteristic	Min.	Typ.	Max.	Unit
Supply voltage (V_{supply}) ^{1, 2}	1.5	5.0	12.0	Vdc
Supply current (at 5.0 Vdc supply)	-	0.6	1	mA
Operating temperature range ³	-40 [-40]	-	125 [257]	°C [°F]
Compensated temperature range ⁴	0 [32]	-	85 [185]	°C [°F]
Output resistance	-	2.5	-	kOhm

¹Ratiometricity of the sensor (the ability of the device output to scale to the supply voltage) is achieved within the specified operating voltage.

²Incorrect application of supply voltage or ground to the wrong pin may cause electrical failure.

³Operating temperature range: The temperature range over which the sensor will produce an output proportional to pressure.

⁴Compensated temperature range: The temperature range over which the sensor will produce an output proportional to pressure within the specified performance limits.

Table 3. Environmental Specifications

Characteristic	Parameter
Humidity: all external surfaces internal surfaces of silicone gel coating option internal surfaces of no gel coating option	0 %RH to 95 %RH, non-condensing 0 %RH to 100 %RH, condensing 0 %RH to 95 %RH, non-condensing
Vibration	MIL-STD-202F, Method 214A, Condition 1E (15 g, 10 Hz to 2 kHz)
Shock	MIL-STD-202F, Method 213B, Condition F (100 g, 6 ms duration)
Life ¹	1 million pressure cycles min.
Solder reflow	J-STD-020-D, MSL 1 (unlimited shelf life when stored at less than 30 °C and 85 %RH)

¹Life may vary depending on specific application in which sensor is utilized.

CAUTION

MEDIA INCOMPATIBILITY

- No gel coating option: The input port is limited to non-corrosive, non-ionic media such as dry air and gases and should not be exposed to condensation. The gases are limited to media that are compatible with the following wetted materials of construction: high temperature polyamide, silicone, epoxy, alumina ceramic, silicon, gold, and glass.
- Silicone gel coating option: The gel coated sensors use the same materials in the wetted media path but are protected from condensation by a silicone-based gel coating. The gel coating option allows use in applications where condensation can occur.

Failure to comply with these instructions may result in product damage.

TBP Series, Compensated/Unamplified

Table 4. Wetted Materials

Component	No Gel Coating Option	Silicone Gel Coating Option
Ports	high temperature polyamide	high temperature polyamide
Substrate	alumina ceramic	not exposed - protected by silicone gel
Adhesives	epoxy, RTV	epoxy
Electronic components	silicon, gold, glass	not exposed - protected by silicone gel

Table 5. Pressure Range Specifications for 60 mbar to 10 bar

Pressure Range Order Code (see Figure 1)	Pressure Range		Unit	Over Pressure	Burst Pressure	Pressure Accuracy ^{1,2} (%FSS)	Offset ³ (mV/V)	Full Scale Span (mV/V)			Thermal Effect on Offset ⁴ (%FSS)		Thermal Effect on Span ⁵ (%FSS)		Long-Term Stability 1000 hr at 25 °C (%FSS)	Thermal Hysteresis No Gel Option ⁶ (%FSS)	Thermal Hysteresis Silicone Gel Option ⁶ (%FSS)
	Pmin.	Pmax.						Min.	Nom.	Max.	10 °C to 50 °C	0 °C to 85 °C	10 °C to 50 °C	0 °C to 85 °C			
Gage																	
060MG	0	60	mbar	872	1370	±0.20	±0.075	1.23	1.30	1.40	±1.15	±2.35	±1.00	±2.00	±0.45	±0.40	±0.60
100MG	0	100	mbar	872	1370	±0.20	±0.075	2.06	2.20	2.33	±0.70	±1.40	±1.00	±2.00	±0.30	±0.25	±0.35
160MG	0	160	mbar	2000	4000	±0.15	±0.12	2.18	2.30	2.46	±1.65	±3.30	±0.75	±2.00	±0.55	±0.35	±0.55
250MG	0	250	mbar	2000	4000	±0.15	±0.12	3.41	3.65	3.85	±1.05	±2.10	±0.75	±2.00	±0.35	±0.20	±0.35
400MG	0	400	mbar	2000	4000	±0.15	±0.12	5.45	5.80	6.15	±0.65	±1.30	±0.75	±2.00	±0.20	±0.15	±0.20
600MG	0	600	mbar	4000	8000	±0.15	±0.075	2.94	3.05	3.18	±0.85	±1.65	±0.50	±1.25	±0.40	±0.15	±0.35
001BG	0	1	bar	4	8	±0.15	±0.075	4.90	5.10	5.30	±0.50	±1.00	±0.50	±1.25	±0.25	±0.10	±0.20
1.6BG	0	1.6	bar	4	8	±0.15	±0.075	7.84	8.15	8.48	±0.30	±0.65	±0.50	±1.25	±0.15	±0.10	±0.15
2.5BG	0	2.5	bar	8	17	±0.15	±0.075	6.10	6.35	6.59	±0.40	±0.80	±0.50	±1.50	±0.20	±0.10	±0.15
004BG	0	4	bar	10	17	±0.15	±0.075	5.57	5.80	6.04	±0.50	±1.00	±0.50	±1.25	±0.25	±0.10	±0.20
006BG	0	6	bar	17	21	±0.15	±0.075	5.08	5.30	5.54	±0.65	±1.00	±0.50	±1.00	±0.25	±0.15	±0.25
010BG	0	10	bar	17	21	±0.15	±0.075	8.47	8.85	9.22	±0.40	±0.60	±0.50	±1.00	±0.15	±0.10	±0.15

¹Accuracy: The maximum deviation in output from a Best Fit Straight Line (BFSL) fitted to the output measured over the pressure range at 25 °C [77 °F]. Includes all errors due to pressure non-linearity, pressure hysteresis, and non-repeatability.

²Full Scale Span: The algebraic difference between the output signal measured at the maximum and minimum limits of the pressure range (see Figure 1) for pressure ranges).

³Offset: The output signal obtained when the reference pressure is applied to all available pressure ports. Also known as “null” or “zero”.

⁴Thermal effect on offset: The deviation in offset due to changes in temperature over the compensated temperature range, relative to offset measured at 25 °C.

⁵Thermal effect on span: The deviation in full scale span due to changes in temperature over the compensated temperature range, relative to full scale span measured at 25 °C.

⁶Thermal hysteresis: The maximum difference between output readings when the same temperature is reached consecutively, under the same operating conditions, with temperature approaching from opposite directions within the operating temperature range. Validated over the full operating temperature and pressure ranges using a ~5 °C/ minute ramp and 30 minute dwell. Application performance may be affected by thermal mass of end user system.

Basic Board Mount Pressure Sensors

Table 6. Pressure Range Specifications for 6 kPa to 1 MPa

Pressure Range Order Code (see Figure 1)	Pressure Range		Unit	Over Pressure	Burst Pressure	Pressure Accuracy ^{1,2} (%FSS)	Offset ³ (mV/V)	Full Scale Span (mV/V)			Thermal Effect on Offset ⁴ (%FSS)		Thermal Effect on Span ⁵ (%FSS)		Long-Term Stability 1000 hr at 25 °C (%FSS)	Thermal Hysteresis No Gel Option ⁶ (%FSS)	Thermal Hysteresis Silicone Gel Option ⁶ (%FSS)
	Pmin.	Pmax.						Min.	Nom.	Max.	10 °C to 50 °C	0 °C to 85 °C	10 °C to 50 °C	0 °C to 85 °C			
Gage																	
006KG	0	6	kPa	87	137	±0.20	±0.075	1.23	1.30	1.40	±1.15	±2.35	±1.00	±2.00	±0.45	±0.40	±0.60
010KG	0	10	kPa	87	137	±0.20	±0.075	2.06	2.20	2.33	±0.70	±1.40	±1.00	±2.00	±0.30	±0.25	±0.35
016KG	0	16	kPa	200	400	±0.15	±0.12	2.18	2.30	2.46	±1.65	±3.30	±0.75	±2.00	±0.55	±0.35	±0.55
025KG	0	25	kPa	200	400	±0.15	±0.12	3.41	3.65	3.85	±1.05	±2.10	±0.75	±2.00	±0.35	±0.20	±0.35
040KG	0	40	kPa	200	400	±0.15	±0.12	5.45	5.80	6.15	±0.65	±1.30	±0.75	±2.00	±0.20	±0.15	±0.20
060KG	0	60	kPa	400	800	±0.15	±0.075	2.94	3.05	3.18	±0.85	±1.65	±0.50	±1.25	±0.40	±0.15	±0.35
100KG	0	100	kPa	400	800	±0.15	±0.075	4.90	5.10	5.30	±0.50	±1.00	±0.50	±1.25	±0.25	±0.10	±0.20
160KG	0	160	kPa	400	800	±0.15	±0.075	7.84	8.15	8.48	±0.30	±0.65	±0.50	±1.25	±0.15	±0.10	±0.15
250KG	0	250	kPa	800	1700	±0.15	±0.075	6.10	6.35	6.59	±0.40	±0.80	±0.50	±1.50	±0.20	±0.10	±0.15
400KG	0	400	kPa	1000	1700	±0.15	±0.075	5.57	5.80	6.04	±0.50	±1.00	±0.50	±1.25	±0.25	±0.10	±0.20
600KG	0	600	kPa	1700	2100	±0.15	±0.075	5.08	5.30	5.54	±0.65	±1.00	±0.50	±1.00	±0.25	±0.15	±0.25
001GG	0	1	MPa	1.70	2.10	±0.15	±0.075	8.47	8.85	9.22	±0.40	±0.60	±0.50	±1.00	±0.15	±0.10	±0.15

¹Accuracy: The maximum deviation in output from a Best Fit Straight Line (BFSL) fitted to the output measured over the pressure range at 25 °C [77 °F]. Includes all errors due to pressure non-linearity, pressure hysteresis, and non-repeatability.

²Full Scale Span: The algebraic difference between the output signal measured at the maximum and minimum limits of the pressure range (see Figure 1) for pressure ranges).

³Offset: The output signal obtained when the reference pressure is applied to all available pressure ports. Also known as “null” or “zero”.

⁴Thermal effect on offset: The deviation in offset due to changes in temperature over the compensated temperature range, relative to offset measured at 25 °C.

⁵Thermal effect on span: The deviation in full scale span due to changes in temperature over the compensated temperature range, relative to full scale span measured at 25 °C.

⁶Thermal hysteresis: The maximum difference between output readings when the same temperature is reached consecutively, under the same operating conditions, with temperature approaching from opposite directions within the operating temperature range. Validated over the full operating temperature and pressure ranges using a ~5 °C/ minute ramp and 30 minute dwell. Application performance may be affected by thermal mass of end user system.

TBP Series, Compensated/Unamplified

Table 7. Pressure Range Specifications for 1 psi to 150 psi

Pressure Range Order Code (see Figure 1)	Pressure Range		Unit	Over Pressure	Burst Pressure	Pressure Accuracy ^{1,2} (%FSS)	Offset ³ (mV/V)	Full Scale Span (mV/V)			Thermal Effect on Offset ⁴ (%FSS)		Thermal Effect on Span ⁵ (%FSS)		Long-Term Stability 1000 hr at 25 °C (%FSS)	Thermal Hysteresis No Gel Option ⁶ (%FSS)	Thermal Hysteresis Silicone Gel Option ⁶ (%FSS)
	Pmin.	Pmax.						Min.	Nom.	Max.	10 °C to 50 °C	0 °C to 85 °C	10 °C to 50 °C	0 °C to 85 °C			
Gage																	
001PG	0	1	psi	12.7	20	±0.20	±0.075	1.42	1.50	1.61	±1.00	±2.05	±1.00	±2.00	±0.40	±0.35	±0.50
005PG	0	5	psi	30	60	±0.15	±0.12	4.70	5.00	5.30	±0.75	±1.50	±0.75	±2.00	±0.25	±0.15	±0.25
015PG	0	15	psi	60	115	±0.15	±0.075	5.06	5.25	5.49	±0.50	±0.95	±0.50	±1.25	±0.25	±0.10	±0.20
030PG	0	30	psi	115	245	±0.15	±0.075	5.05	5.25	5.45	±0.50	±0.95	±0.50	±1.50	±0.25	±0.10	±0.20
060PG	0	60	psi	145	245	±0.15	±0.075	5.76	6.00	6.24	±0.50	±0.95	±0.50	±1.25	±0.25	±0.10	±0.20
100PG	0	100	psi	245	300	±0.15	±0.075	5.83	6.10	6.36	±0.60	±0.85	±0.50	±1.00	±0.25	±0.10	±0.25
150PG	0	150	psi	245	300	±0.15	±0.075	8.75	9.15	9.54	±0.40	±0.60	±0.50	±1.00	±0.15	±0.10	±0.15

¹Accuracy: The maximum deviation in output from a Best Fit Straight Line (BFSL) fitted to the output measured over the pressure range at 25 °C [77 °F]. Includes all errors due to pressure non-linearity, pressure hysteresis, and non-repeatability.

²Full Scale Span: The algebraic difference between the output signal measured at the maximum and minimum limits of the pressure range (see Figure 1) for pressure ranges).

³Offset: The output signal obtained when the reference pressure is applied to all available pressure ports. Also known as “null” or “zero”.

⁴Thermal effect on offset: The deviation in offset due to changes in temperature over the compensated temperature range, relative to offset measured at 25 °C.

⁵Thermal effect on span: The deviation in full scale span due to changes in temperature over the compensated temperature range, relative to full scale span measured at 25 °C.

⁶Thermal hysteresis: The maximum difference between output readings when the same temperature is reached consecutively, under the same operating conditions, with temperature approaching from opposite directions within the operating temperature range. Validated over the full operating temperature and pressure ranges using a ~5 °C/ minute ramp and 30 minute dwell. Application performance may be affected by thermal mass of end user system.

Table 8. Sensor Pressure Type

Pressure Type	Description
Gage	Output is proportional to the difference between applied pressure and atmospheric (ambient) pressure. Reference pressure is atmospheric pressure.

Figure 2. TBP Series Typical Temperature Performance

The graph below indicates typical error multipliers for Thermal Effect on Offset (TEO) and Thermal Effect on Span (TES) outside the Compensated Temperature Range. See Tables 5-7 for details of the specified maximum errors within the Compensated Temperature Range.

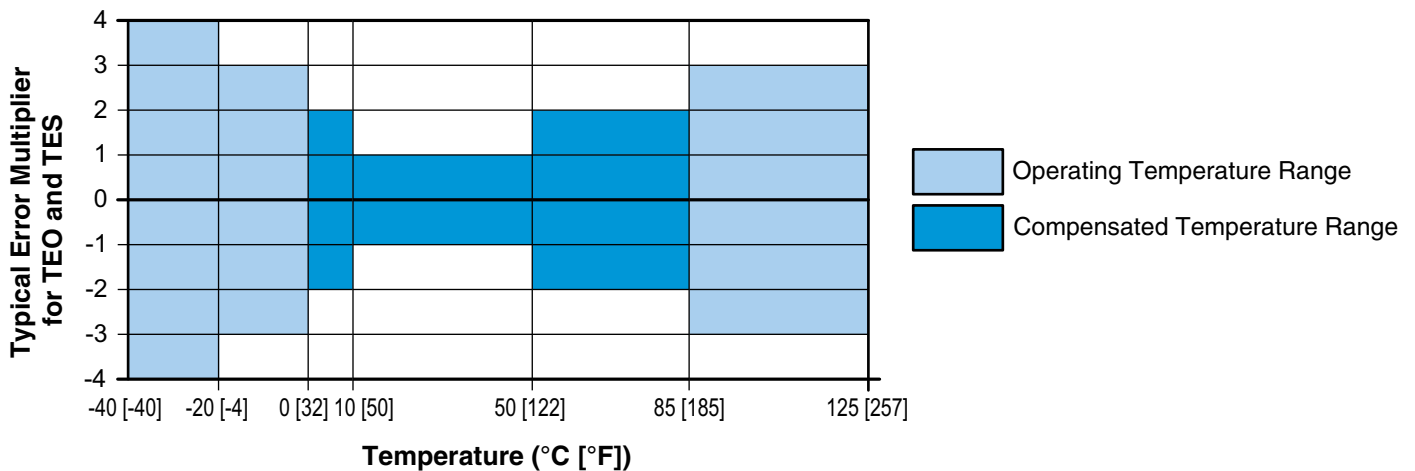

Basic Board Mount Pressure Sensors

Figure 3. DIP Package Dimensional Drawings (For reference only: mm [in].)

Dimensions

Recommended PCB Pad Layout

AN: Single axial barbed port

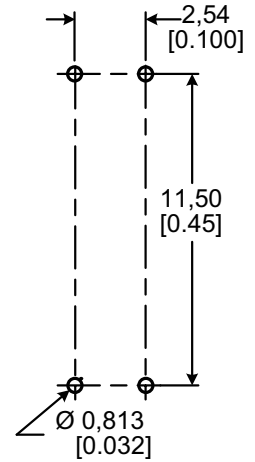
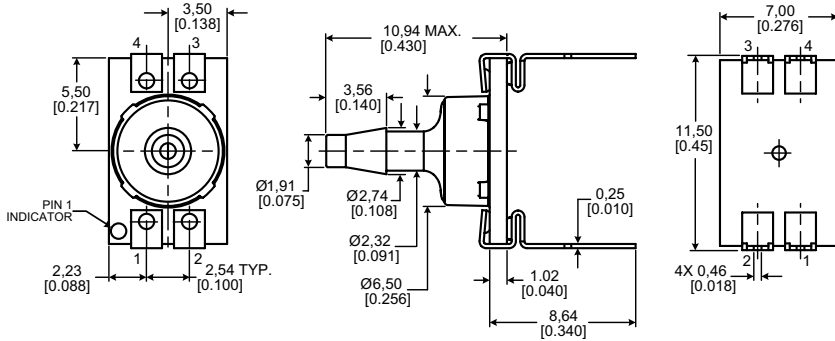

LN: Single axial barbless port

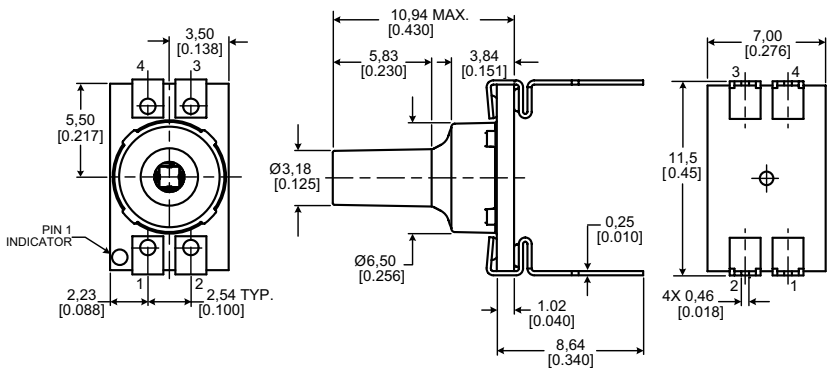
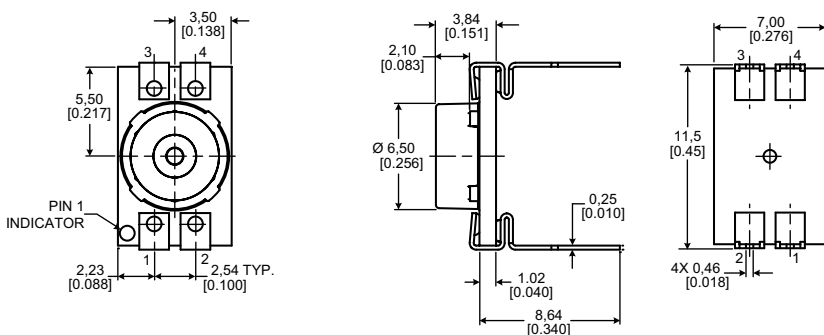

Table 8. Pinout for DIP Packages

Pin 4	Pin 3
Vout+	GND
Pin 1	Pin 2
Vsupply	Vout-

PN: Low-profile port



TBP Series, Compensated/Unamplified

Figure 4. Leadless SMT Package Dimensional Drawings (For reference only: mm [in].)

Dimensions

Recommended PCB Pad Layout

AN: Single axial barbed port

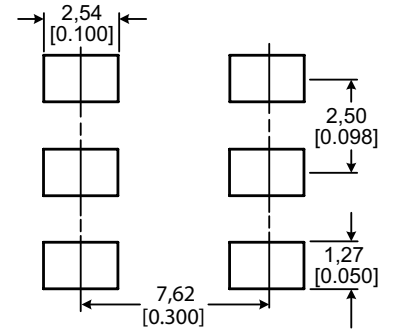
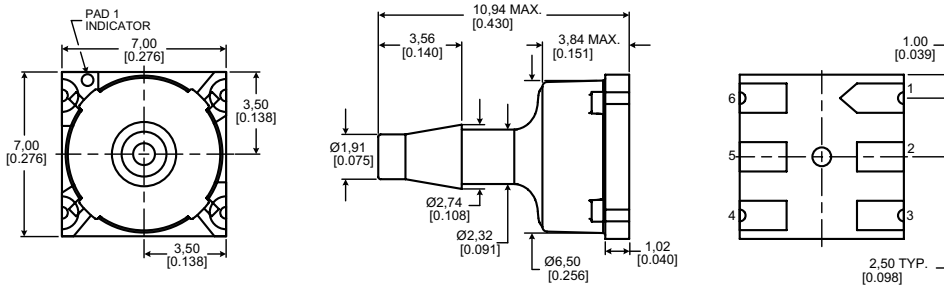
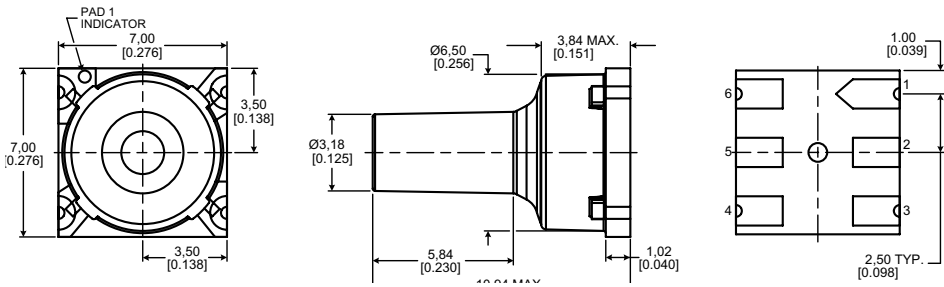

Table 9. Pinout for Leadless SMT Pressure Packages

Pad 1	Pad 6
Vsupply	Vout+
Pad 2	Pad 5
NC	NC
Pad 3	Pad 4
Vout-	GND

LN: Single axial barbless port



PN: Low-profile port

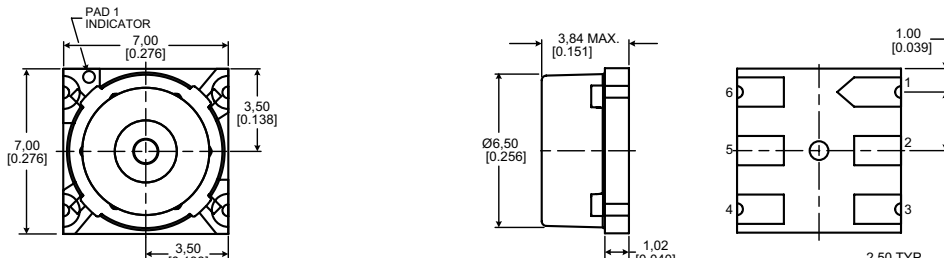

Basic Board Mount Pressure Sensors

Figure 5. SMT Package Dimensional Drawings (For reference only: mm [in])

Dimensions

Recommended PCB Pad Layout

AN: Single axial barbed port

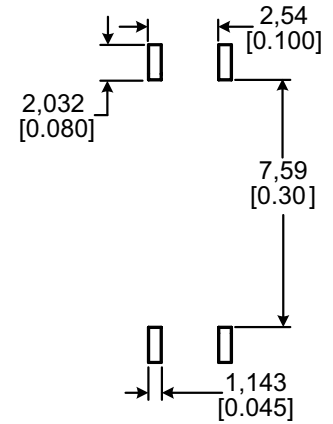
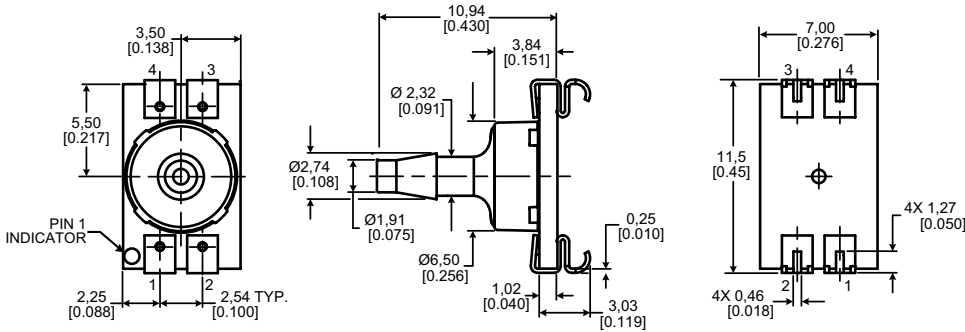

LN: Single axial barless port

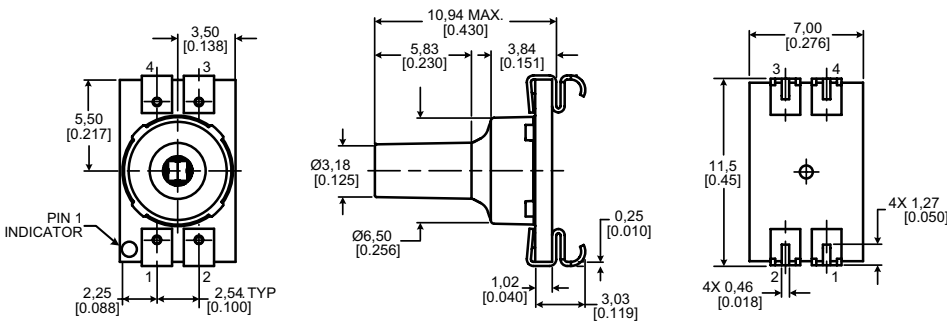
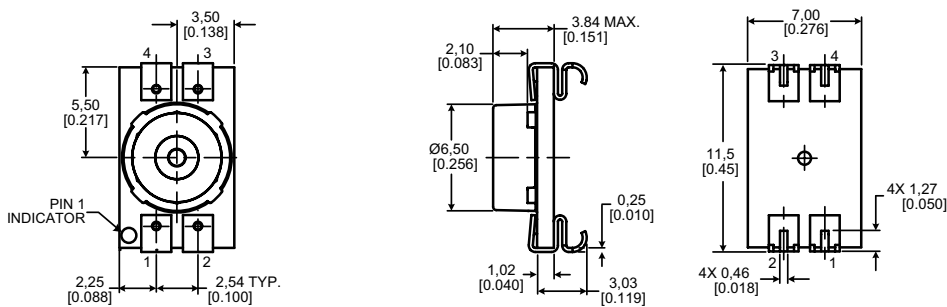

Table 10. Pinout for SMT Packages

Pin 4	Pin 3
Vout+	GND
Pin 1	Pin 2
Vsupply	Vout-

PN: Low-profile port



TBP Series, Compensated/Unamplified

ADDITIONAL INFORMATION

The following associated literature is available at sensing.honeywell.com:

- Product line guide
- Product range guide
- Product installation instructions
- Product nomenclature tree
- Selection guides:
 - Basic Pressure Sensor Product Flyer
 - Board Mount Pressure Sensors Selection Guide
- Application information:
- Technical information:
 - Output Signal Adjustment and Temperature Compensation for Honeywell Basic Board Mount Pressure Sensors: NBP Series–Uncompensated/Unamplified and TBP Series–Compensated/Unamplified
 - Pneumatic Interface Recommendations for Honeywell Basic Board Mount Pressure Sensors: NBP Series–Uncompensated/Unamplified and TBP Series–Compensated/Unamplified

⚠ WARNING **PERSONAL INJURY**

DO NOT USE these products as safety or emergency stop devices or in any other application where failure of the product could result in personal injury.

Failure to comply with these instructions could result in death or serious injury.

⚠ WARNING **MISUSE OF DOCUMENTATION**

- The information presented in this datasheet is for reference only. Do not use this document as a product installation guide.
- Complete installation, operation, and maintenance information is provided in the instructions supplied with each product.

Failure to comply with these instructions could result in death or serious injury.

WARRANTY/REMEDY

Honeywell warrants goods of its manufacture as being free of defective materials and faulty workmanship. Honeywell's standard product warranty applies unless agreed to otherwise by Honeywell in writing; please refer to your order acknowledgement or consult your local sales office for specific warranty details. If warranted goods are returned to Honeywell during the period of coverage, Honeywell will repair or replace, at its option, without charge those items it finds defective. **The foregoing is buyer's sole remedy and is in lieu of all other warranties, expressed or implied, including those of merchantability and fitness for a particular purpose. In no event shall Honeywell be liable for consequential, special, or indirect damages.**

While we provide application assistance personally, through our literature and the Honeywell website, it is up to the customer to determine the suitability of the product in the application.

Specifications may change without notice. The information we supply is believed to be accurate and reliable as of this printing. However, we assume no responsibility for its use.

Sales and Service

Honeywell serves its customers through a worldwide network of sales offices, representatives and distributors. For application assistance, current specifications, pricing or name of the nearest Authorized Distributor, contact your local sales office or email us at **info.sc@honeywell.com**. Visit us on the Web at **sensing.honeywell.com**

Phone and Fax:

Asia Pacific	+65 6355-2828
	+65 6445-3033 Fax
Europe	+44 (0) 1698 481481
	+44 (0) 1698 481676 Fax
Latin America	+1-305-805-8188
	+1-305-883-8257 Fax
USA/Canada	+1-800-537-6945
	+1-815-235-6847
	+1-815-235-6545 Fax

Sensing and Control
Honeywell
1985 Douglas Drive North
Golden Valley, MN 55422
honeywell.com

50092900-EN REV. A
February 2014
© 2014 Honeywell International Inc. All rights reserved.

The Honeywell logo is displayed in a bold, red, sans-serif font.