

# Cree® XLamp® ML Family LEDs



## INTRODUCTION

This document describes the product nomenclature required to select and order Cree’s XLamp ML family of LEDs. XLamp ML family LEDs are tested and sorted into bins which are then combined into orderable kits identified by an order code.

All XLamp LEDs are tested and sorted by color and brightness into a unique bin. Each bin contains LEDs from only one color and brightness group and is uniquely identified by a bin code. White XLamp LEDs are sorted by chromaticity (color) and luminous flux (brightness). Color XLamp LEDs are sorted by dominant wavelength (color) and luminous flux (brightness). LEDs are shipped on reels containing LEDs from one bin and are always labeled with the appropriate bin code.

Kits contain LEDs from a number of similar bins and are fully defined by their order codes. A full explanation of the order codes for XLamp ML family LEDs, as well as a list of standard order codes, is provided in this document.

## TABLE OF CONTENTS

- Bin and Order-Code Format ..... 2
- Performance Groups – Luminous Or Radiant Flux.. 3
- Performance Groups – Dominant Wavelength ..... 4
- Performance Groups – Chromaticity ..... 5
- Cree’s Standard Chromaticity Regions Plotted on the 1931 CIE Curve ..... 8
- Cree’s Standard Cool White Kits Plotted on ANSI Standard Chromaticity Regions..... 9
- Cree’s Standard Warm and Neutral White Kits Plotted on ANSI Standard Chromaticity Regions...11
- Cree’s Standard Chromaticity Kits.....13
- Standard Order Codes and Bins
  - ML-B Cool White.....14
  - ML-B Warm White.....14
  - ML-C Parallel, Cool White.....16
  - ML-C Parallel, Warm White.....18
  - ML-C Series, Cool White .....20
  - ML-C Series, Warm White .....21
  - ML-C Color .....23
  - ML-E Parallel, Cool White .....24
  - ML-E Parallel, Warm White .....25
  - ML-E Series, Cool White .....28
  - ML-E Series, Warm White .....29
  - ML-E Parallel Color.....31
  - ML-E Series Color .....33

**BIN AND ORDER-CODE FORMAT**

Bin codes and order codes are configured in the following manner:

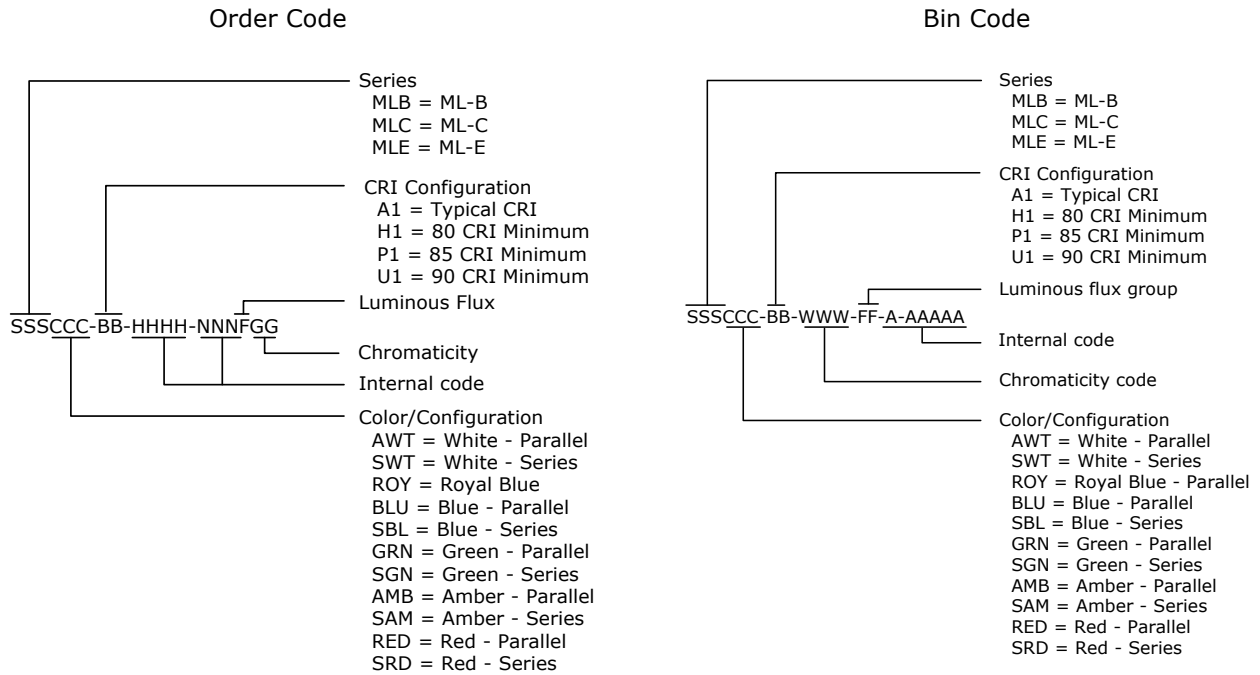

## PERFORMANCE GROUPS – LUMINOUS OR RADIANT FLUX

White XLamp ML family LEDs are tested for luminous flux and placed into one of the following luminous-flux groups:

Group Code	Min. Luminous Flux	Max. Luminous Flux
F0*	10.7	13.9
F2	10.7	12.3
F3	12.3	13.9
G0	13.9	18.1
G2	13.9	15.8
G3	15.8	18.1
H0*	18.1	23.5
H2	18.1	20.6
H3	20.6	23.5
J0*	23.5	30.6
J2	23.5	26.8
J3	26.8	30.6
K2	30.6	35.2
K3	35.2	39.8
M2	39.8	45.7
M3	45.7	51.7
N2	51.7	56.8
N3	56.8	62

### Notes:

- Flux codes F0, G0, H0 and J0 are further subdivided into F2, F3, G2, G3 and H2, H3, respectively. Orders for the F0 flux code may be filled with either F2 or F3 sub-codes, orders for the G0 flux code may be filled with either G2 or G3 sub-codes, orders for the H0 flux code may be filled with H2 or H3 sub-codes, and orders for the J0 flux code may be filled with J2 or J3 sub-codes.

Royal-blue XLamp LEDs are tested for radiant flux and sorted into one of the following radiant-flux bins.

Group	Min. Radiant Flux (mW)	Max. Radiant Flux (mW)
03	50	60
04	60	70
05	70	85
06	85	100
07	100	122
08	122	147
09	147	175
10	175	210
11	210	250
12	250	300
13	300	350
14	350	425

**PERFORMANCE GROUPS – DOMINANT WAVELENGTH**

The XLamp ML-E color LEDs are tested individually for dominant wavelength (DWL) and sorted into one of the DWL bins defined below.

Color	DWL Group	Min. DWL (nm)	Max. DWL (nm)
Royal Blue	D36	450	452.5
	D37	452.5	455
	D46	455	457.5
	D47	457.5	460
	D56	460	462.5
	D57	462.5	465
Blue	B3	465	470
	B4	470	475
	B5	475	480
	B6	480	485
Green	G2	520	525
	G3	525	530
	G4	530	535
Amber	A2	585	590
	A3	590	595
Red	R2	620	625
	R3	625	630

**PERFORMANCE GROUPS – CHROMATICITY**

Region	x	y	Region	x	y	Region	x	y	Region	x	y
0A	0.2950	0.2970	0B	0.2920	0.3060	0C	0.2984	0.3133	0D	0.2984	0.3133
	0.2920	0.3060		0.2895	0.3135		0.2962	0.3220		0.3048	0.3207
	0.2984	0.3133		0.2962	0.3220		0.3028	0.3304		0.3068	0.3113
	0.3009	0.3042		0.2984	0.3133		0.3048	0.3207		0.3009	0.3042
0R	0.2980	0.2880	0S	0.2895	0.3135	0T	0.2962	0.3220	0U	0.3037	0.2937
	0.2950	0.2970		0.2870	0.3210		0.2937	0.3312		0.3009	0.3042
	0.3009	0.3042		0.2937	0.3312		0.3005	0.3415		0.3068	0.3113
	0.3037	0.2937		0.2962	0.3220		0.3028	0.3304		0.3093	0.2993
1A	0.3048	0.3207	1B	0.3028	0.3304	1C	0.3115	0.3391	1D	0.3130	0.3290
	0.3130	0.3290		0.3115	0.3391		0.3205	0.3481		0.3213	0.3373
	0.3144	0.3186		0.3130	0.3290		0.3213	0.3373		0.3221	0.3261
	0.3068	0.3113		0.3048	0.3207		0.3130	0.3290		0.3144	0.3186
1R	0.3068	0.3113	1S	0.3005	0.3415	1T	0.3099	0.3509	1U	0.3144	0.3186
	0.3144	0.3186		0.3099	0.3509		0.3196	0.3602		0.3221	0.3261
	0.3161	0.3059		0.3115	0.3391		0.3205	0.3481		0.3231	0.3120
	0.3093	0.2993		0.3028	0.3304		0.3115	0.3391		0.3161	0.3059
2A	0.3215	0.3350	2B	0.3207	0.3462	2C	0.3290	0.3538	2D	0.3290	0.3417
	0.3290	0.3417		0.3290	0.3538		0.3376	0.3616		0.3371	0.3490
	0.3290	0.3300		0.3290	0.3417		0.3371	0.3490		0.3366	0.3369
	0.3222	0.3243		0.3215	0.3350		0.3290	0.3417		0.3290	0.3300
2R	0.3222	0.3243	2S	0.3196	0.3602	2T	0.3290	0.3690	2U	0.3290	0.3300
	0.3290	0.3300		0.3290	0.3690		0.3381	0.3762		0.3366	0.3369
	0.3290	0.3180		0.3290	0.3538		0.3376	0.3616		0.3361	0.3245
	0.3231	0.3120		0.3207	0.3462		0.3290	0.3538		0.3290	0.3180
3A	0.3371	0.3490	3B	0.3376	0.3616	3C	0.3463	0.3687	3D	0.3451	0.3554
	0.3451	0.3554		0.3463	0.3687		0.3551	0.3760		0.3533	0.3620
	0.3440	0.3427		0.3451	0.3554		0.3533	0.3620		0.3515	0.3487
	0.3366	0.3369		0.3371	0.3490		0.3451	0.3554		0.3440	0.3427
3R	0.3366	0.3369	3S	0.3381	0.3762	3T	0.3480	0.3840	3U	0.3440	0.3428
	0.3440	0.3428		0.3480	0.3840		0.3571	0.3907		0.3515	0.3487
	0.3429	0.3307		0.3463	0.3687		0.3551	0.3760		0.3495	0.3339
	0.3361	0.3245		0.3376	0.3616		0.3463	0.3687		0.3429	0.3307
4A	0.3530	0.3597	4B	0.3548	0.3736	4C	0.3641	0.3804	4D	0.3615	0.3659
	0.3615	0.3659		0.3641	0.3804		0.3736	0.3874		0.3702	0.3722
	0.3590	0.3521		0.3615	0.3659		0.3702	0.3722		0.3670	0.3578
	0.3512	0.3465		0.3530	0.3597		0.3615	0.3659		0.3590	0.3521
4R	0.3512	0.3465	4S	0.3571	0.3907	4T	0.3668	0.3957	4U	0.3590	0.3521
	0.3590	0.3521		0.3668	0.3957		0.3771	0.4034		0.3670	0.3578
	0.3567	0.3389		0.3641	0.3804		0.3736	0.3874		0.3640	0.3440
	0.3495	0.3339		0.3548	0.3736		0.3641	0.3804		0.3567	0.3389

**PERFORMANCE GROUPS – CHROMATICITY (CONTINUED)**

Region	x	y	Region	x	y	Region	x	y	Region	x	y
5A1	0.3670	0.3578	5A2	0.3686	0.3649	5A3	0.3744	0.3685	5A4	0.3726	0.3612
	0.3686	0.3649		0.3702	0.3722		0.3763	0.3760		0.3744	0.3685
	0.3744	0.3685		0.3763	0.3760		0.3825	0.3798		0.3804	0.3721
	0.3726	0.3612		0.3744	0.3685		0.3804	0.3721		0.3783	0.3646
5B1	0.3702	0.3722	5B2	0.3719	0.3797	5B3	0.3782	0.3837	5B4	0.3763	0.3760
	0.3719	0.3797		0.3736	0.3874		0.3802	0.3916		0.3782	0.3837
	0.3782	0.3837		0.3802	0.3916		0.3869	0.3958		0.3847	0.3877
	0.3763	0.3760		0.3782	0.3837		0.3847	0.3877		0.3825	0.3798
5C1	0.3825	0.3798	5C2	0.3847	0.3877	5C3	0.3912	0.3917	5C4	0.3887	0.3836
	0.3847	0.3877		0.3869	0.3958		0.3937	0.4001		0.3912	0.3917
	0.3912	0.3917		0.3937	0.4001		0.4006	0.4044		0.3978	0.3958
	0.3887	0.3836		0.3912	0.3917		0.3978	0.3958		0.3950	0.3875
5D1	0.3783	0.3646	5D2	0.3804	0.3721	5D3	0.3863	0.3758	5D4	0.3840	0.3681
	0.3804	0.3721		0.3825	0.3798		0.3887	0.3836		0.3863	0.3758
	0.3863	0.3758		0.3887	0.3836		0.3950	0.3875		0.3924	0.3794
	0.3840	0.3681		0.3863	0.3758		0.3924	0.3794		0.3898	0.3716
6A1	0.3889	0.3690	6A2	0.3915	0.3768	6A3	0.3981	0.3800	6A4	0.3953	0.3720
	0.3915	0.3768		0.3941	0.3848		0.4010	0.3882		0.3981	0.3800
	0.3981	0.3800		0.4010	0.3882		0.4080	0.3916		0.4048	0.3832
	0.3953	0.3720		0.3981	0.3800		0.4048	0.3832		0.4017	0.3751
6B1	0.3941	0.3848	6B2	0.3968	0.3930	6B3	0.4040	0.3966	6B4	0.4010	0.3882
	0.3968	0.3930		0.3996	0.4015		0.4071	0.4052		0.4040	0.3966
	0.4040	0.3966		0.4071	0.4052		0.4146	0.4089		0.4113	0.4001
	0.4010	0.3882		0.4040	0.3966		0.4113	0.4001		0.4080	0.3916
6C1	0.4080	0.3916	6C2	0.4113	0.4001	6C3	0.4186	0.4037	6C4	0.4150	0.3950
	0.4113	0.4001		0.4146	0.4089		0.4222	0.4127		0.4186	0.4037
	0.4186	0.4037		0.4222	0.4127		0.4299	0.4165		0.4259	0.4073
	0.4150	0.3950		0.4186	0.4037		0.4259	0.4073		0.4221	0.3984
6D1	0.4017	0.3751	6D2	0.4048	0.3832	6D3	0.4116	0.3865	6D4	0.4082	0.3782
	0.4048	0.3832		0.4080	0.3916		0.4150	0.3950		0.4116	0.3865
	0.4116	0.3865		0.4150	0.3950		0.4221	0.3984		0.4183	0.3898
	0.4082	0.3782		0.4116	0.3865		0.4183	0.3898		0.4147	0.3814
7A1	0.4147	0.3814	7A2	0.4183	0.3898	7A3	0.4242	0.3919	7A4	0.4203	0.3833
	0.4183	0.3898		0.4221	0.3984		0.4281	0.4006		0.4242	0.3919
	0.4242	0.3919		0.4281	0.4006		0.4342	0.4028		0.4300	0.3939
	0.4203	0.3833		0.4242	0.3919		0.4300	0.3939		0.4259	0.3853
7B1	0.4221	0.3984	7B2	0.4259	0.4073	7B3	0.4322	0.4096	7B4	0.4281	0.4006
	0.4259	0.4073		0.4299	0.4165		0.4364	0.4188		0.4322	0.4096
	0.4322	0.4096		0.4364	0.4188		0.4430	0.4212		0.4385	0.4119
	0.4281	0.4006		0.4322	0.4096		0.4385	0.4119		0.4342	0.4028

**PERFORMANCE GROUPS – CHROMATICITY (CONTINUED)**

Region	x	y	Region	x	y	Region	x	y	Region	x	y
7C1	0.4342	0.4028	7C2	0.4385	0.4119	7C3	0.4449	0.4141	7C4	0.4403	0.4049
	0.4385	0.4119		0.4430	0.4212		0.4496	0.4236		0.4449	0.4141
	0.4449	0.4141		0.4496	0.4236		0.4562	0.4260		0.4513	0.4164
	0.4403	0.4049		0.4449	0.4141		0.4513	0.4164		0.4465	0.4071
7D1	0.4259	0.3853	7D2	0.4300	0.3939	7D3	0.4359	0.3960	7D4	0.4316	0.3873
	0.4300	0.3939		0.4342	0.4028		0.4403	0.4049		0.4359	0.3960
	0.4359	0.3960		0.4403	0.4049		0.4465	0.4071		0.4418	0.3981
	0.4316	0.3873		0.4359	0.3960		0.4418	0.3981		0.4373	0.3893
8A1	0.4373	0.3893	8A2	0.4418	0.3981	8A3	0.4475	0.3994	8A4	0.4428	0.3906
	0.4418	0.3981		0.4465	0.4071		0.4523	0.4085		0.4475	0.3994
	0.4475	0.3994		0.4523	0.4085		0.4582	0.4099		0.4532	0.4008
	0.4428	0.3906		0.4475	0.3994		0.4532	0.4008		0.4483	0.3919
8B1	0.4465	0.4071	8B2	0.4513	0.4164	8B3	0.4573	0.4178	8B4	0.4523	0.4085
	0.4513	0.4164		0.4562	0.4260		0.4624	0.4274		0.4573	0.4178
	0.4573	0.4178		0.4624	0.4274		0.4687	0.4289		0.4634	0.4193
	0.4523	0.4085		0.4573	0.4178		0.4634	0.4193		0.4582	0.4099
8C1	0.4582	0.4099	8C2	0.4634	0.4193	8C3	0.4695	0.4207	8C4	0.4641	0.4112
	0.4634	0.4193		0.4687	0.4289		0.4750	0.4304		0.4695	0.4207
	0.4695	0.4207		0.4750	0.4304		0.4813	0.4319		0.4756	0.4221
	0.4641	0.4112		0.4695	0.4207		0.4756	0.4221		0.4700	0.4126
8D1	0.4483	0.3919	8D2	0.4532	0.4008	8D3	0.4589	0.4021	8D4	0.4538	0.3931
	0.4532	0.4008		0.4582	0.4099		0.4641	0.4112		0.4589	0.4021
	0.4589	0.4021		0.4641	0.4112		0.4700	0.4126		0.4646	0.4034
	0.4538	0.3931		0.4589	0.4021		0.4646	0.4034		0.4593	0.3944
AB2	0.5008	0.4256	AB3	0.5069	0.4254	AC2	0.5131	0.4252	AC3	0.5192	0.4250
	0.5070	0.4350		0.5133	0.4348		0.5196	0.4346		0.5258	0.4343
	0.5133	0.4348		0.5196	0.4346		0.5258	0.4343		0.5321	0.4341
	0.5069	0.4254		0.5131	0.4252		0.5192	0.4250		0.5253	0.4248
AB1	0.4946	0.4162	AB4	0.5006	0.4160	AC1	0.5066	0.4158	AC4	0.5126	0.4156
	0.5008	0.4256		0.5069	0.4254		0.5131	0.4252		0.5192	0.4250
	0.5069	0.4254		0.5131	0.4252		0.5126	0.4156		0.5186	0.4154
	0.5006	0.4160		0.5066	0.4158		0.5001	0.4064		0.5059	0.4062
AA2	0.4884	0.4067	AA3	0.4942	0.4066	AD2	0.5001	0.4064	AD3	0.5059	0.4062
	0.4946	0.4162		0.5006	0.4160		0.5066	0.4158		0.5126	0.4156
	0.5006	0.4160		0.5066	0.4158		0.5126	0.4156		0.5186	0.4154
	0.4942	0.4066		0.5001	0.4064		0.5059	0.4062		0.5118	0.4061
AA1	0.4822	0.3973	AA4	0.4879	0.3972	AD1	0.4936	0.3970	AD4	0.4993	0.3969
	0.4884	0.4067		0.4942	0.4066		0.5001	0.4064		0.5059	0.4062
	0.4942	0.4066		0.5001	0.4064		0.5059	0.4062		0.5118	0.4061
	0.4879	0.3972		0.4936	0.3970		0.4993	0.3969		0.5050	0.3967

**CREE'S STANDARD CHROMATICITY REGIONS PLOTTED ON THE 1931 CIE CURVE**

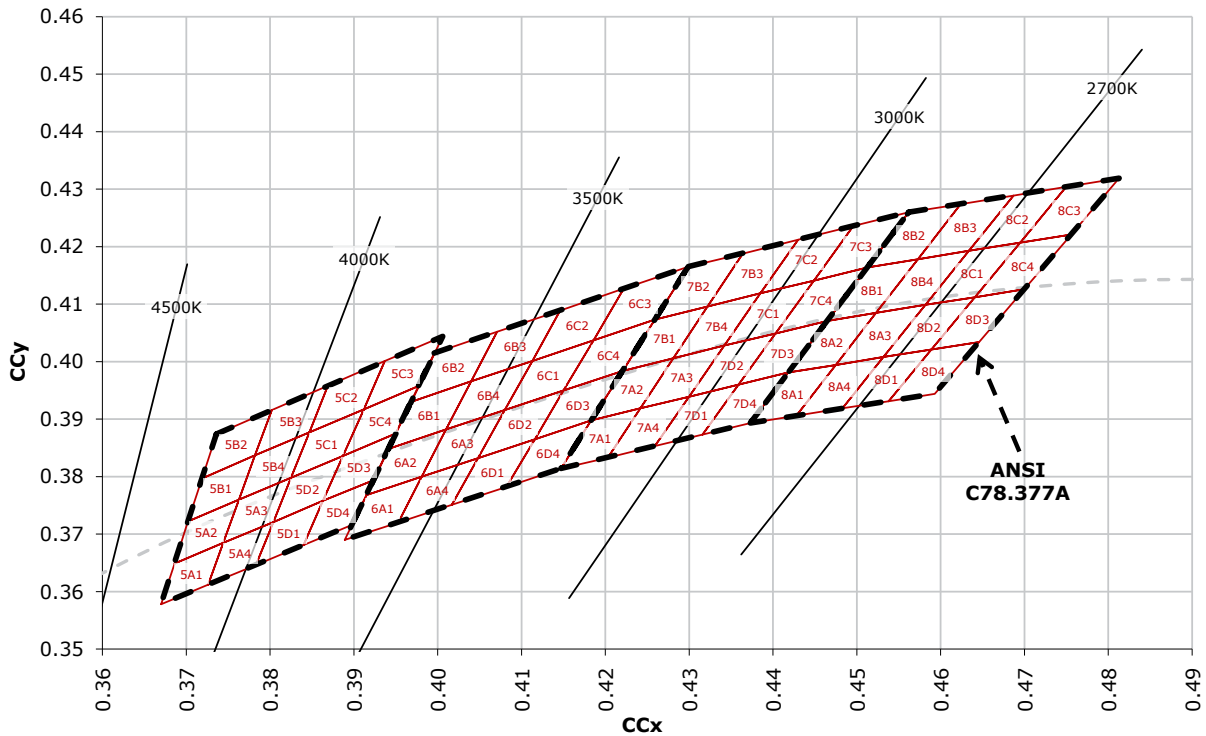
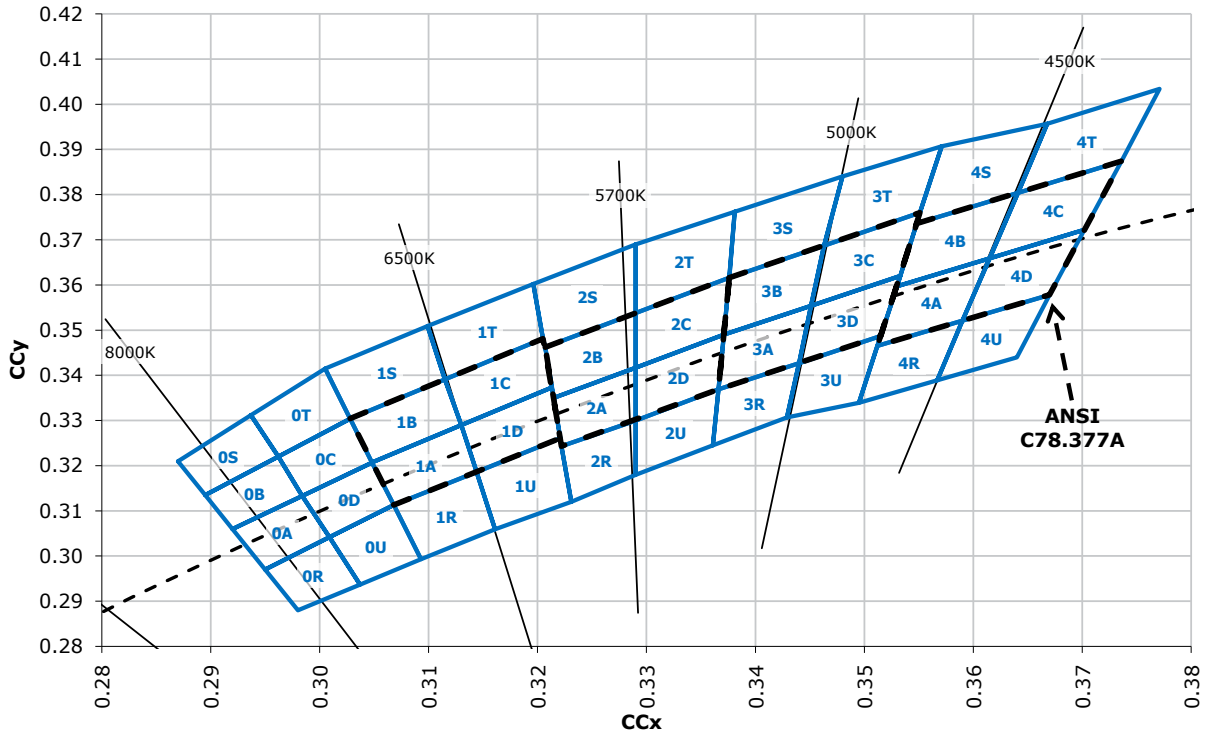



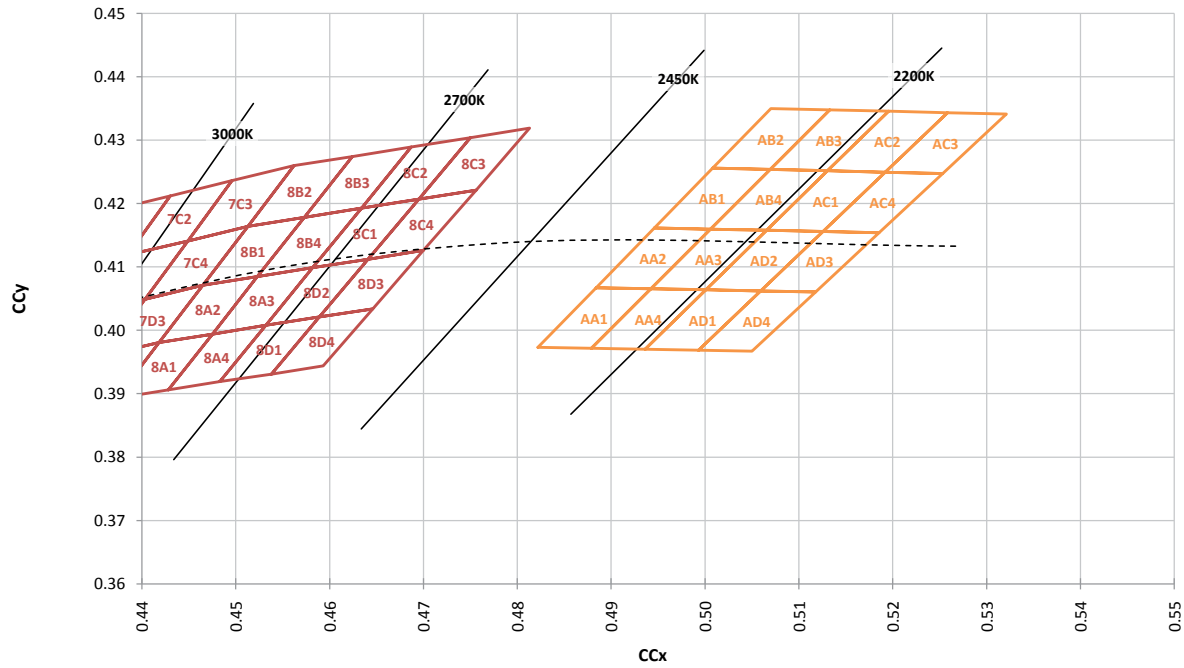

**CREE'S STANDARD COOL WHITE KITS PLOTTED ON ANSI STANDARD CHROMATICITY REGIONS**

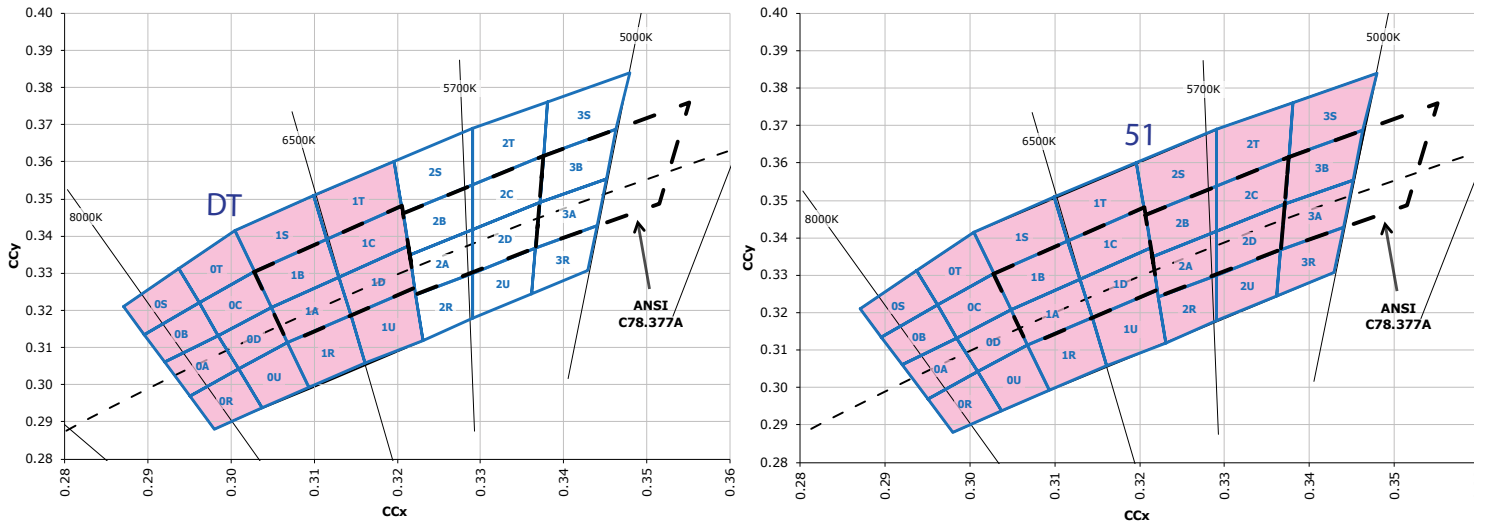

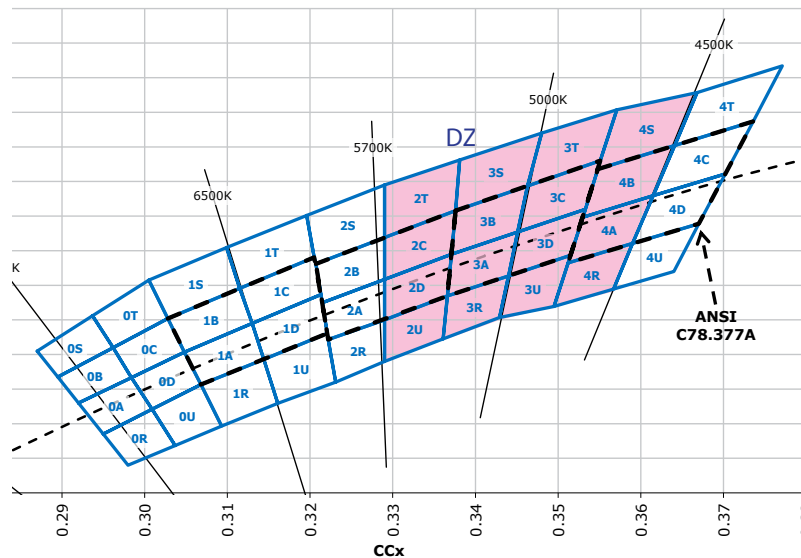
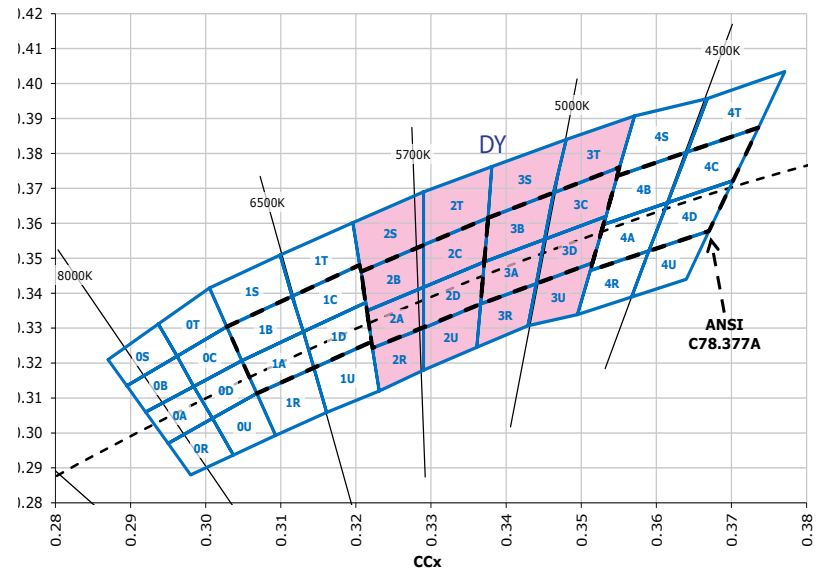
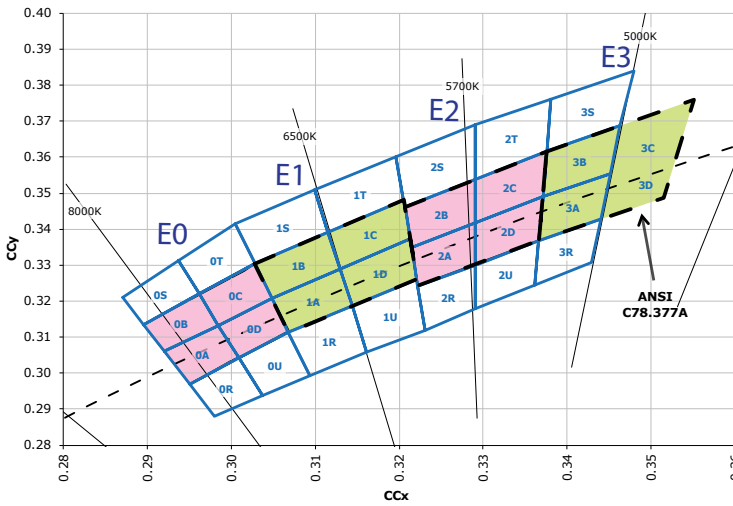
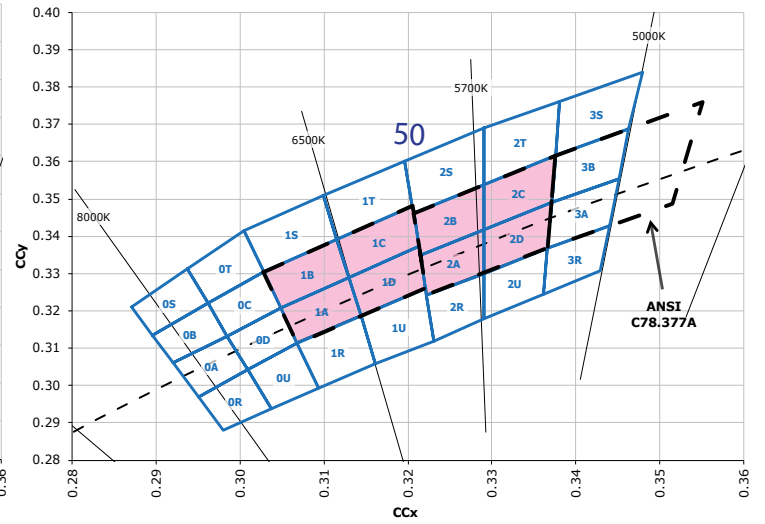
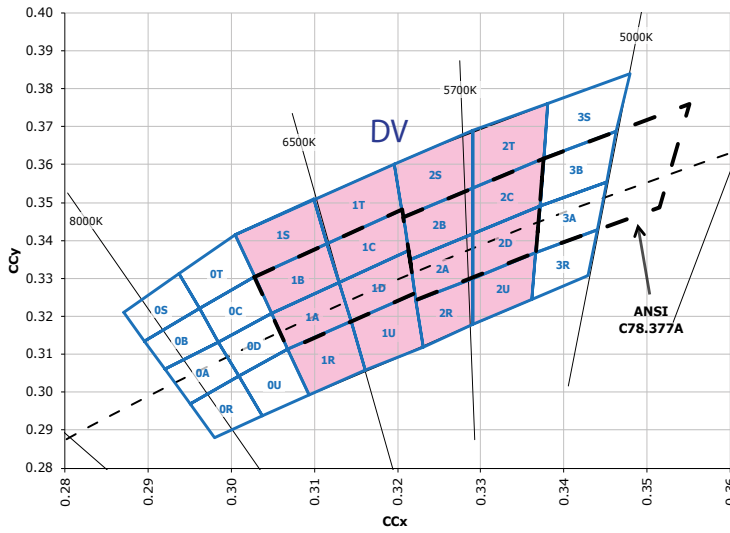

**CREE'S STANDARD WARM AND NEUTRAL WHITE KITS PLOTTED ON ANSI STANDARD CHROMATICITY REGIONS**

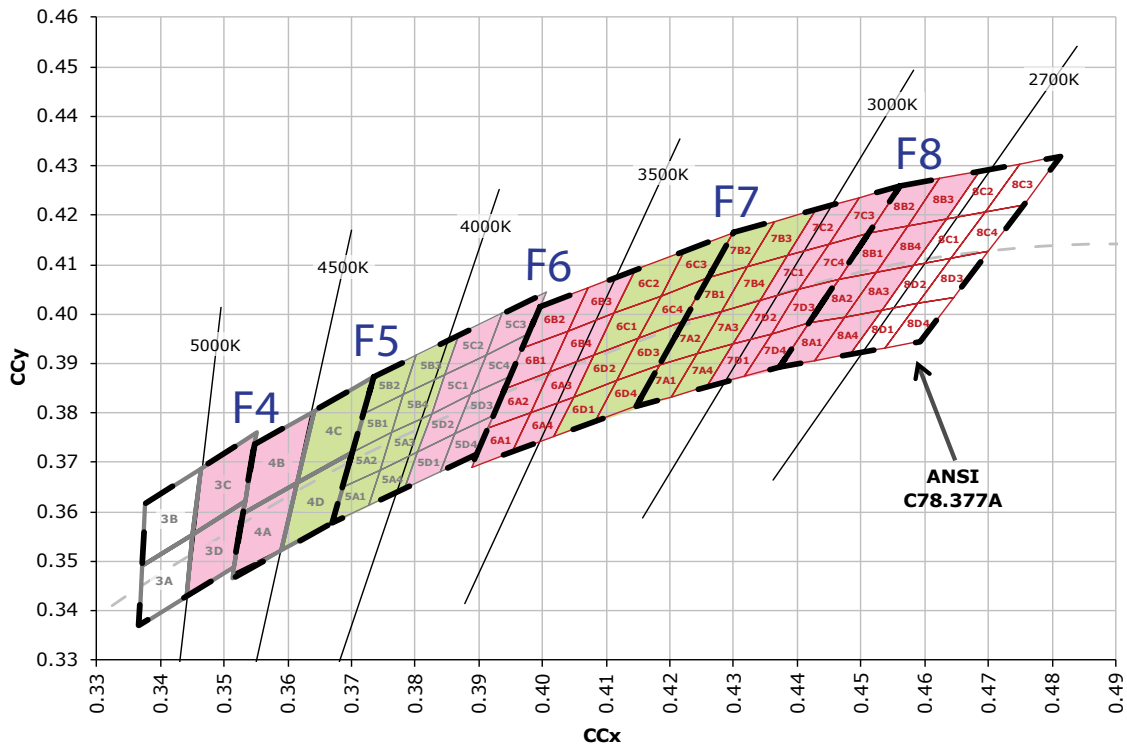
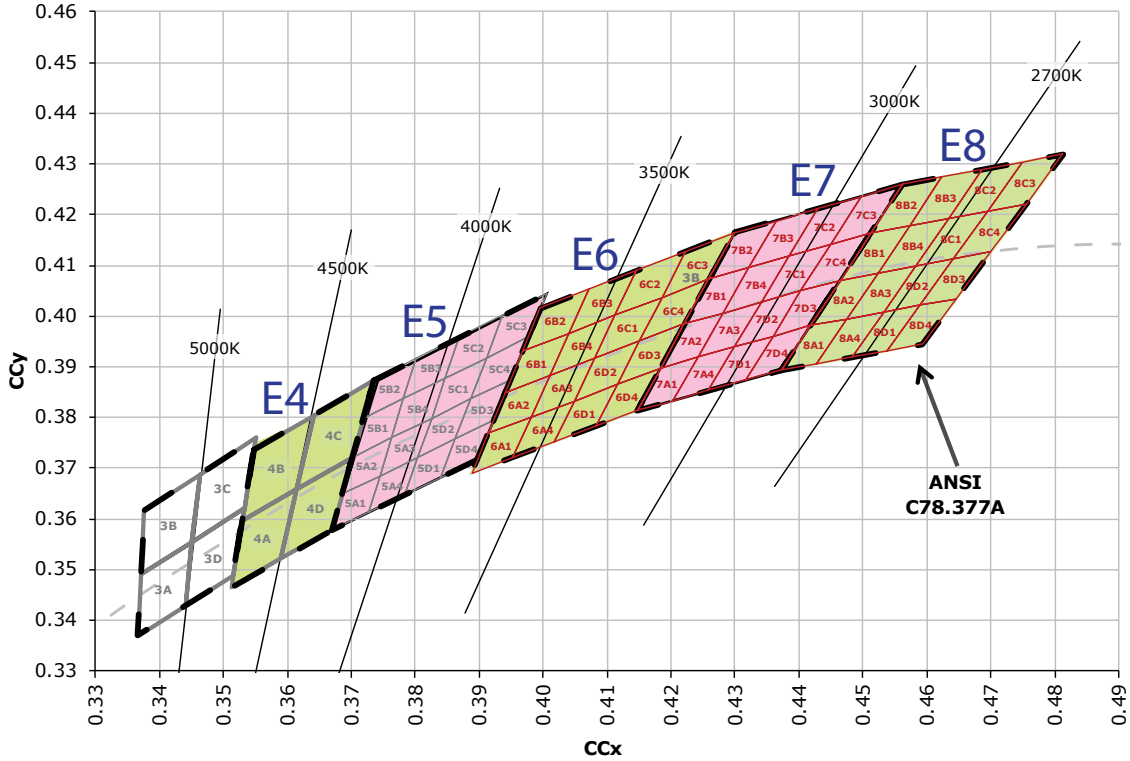

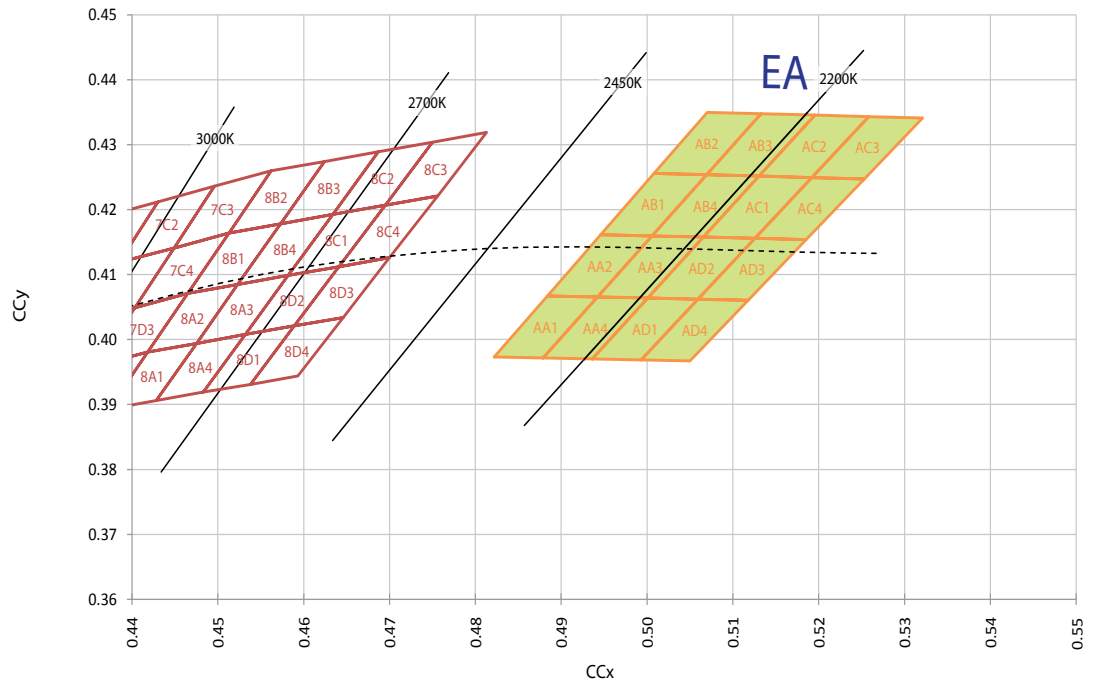
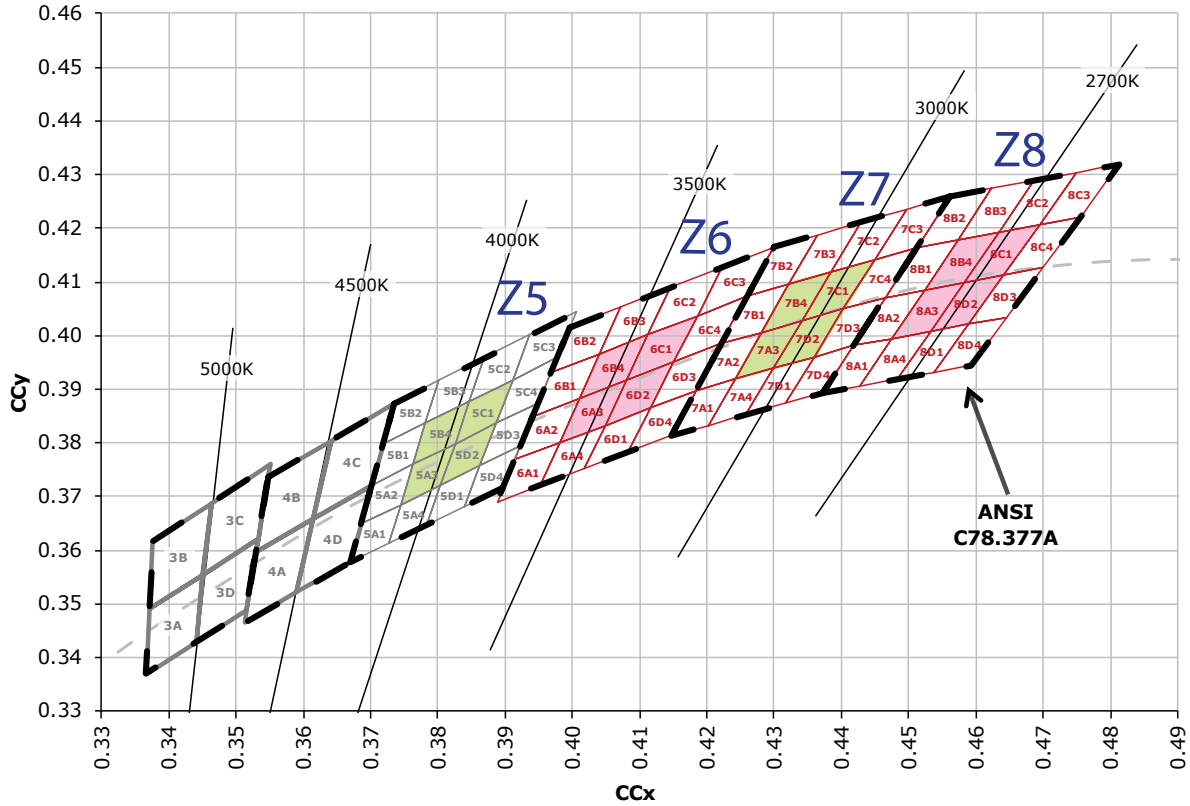

## CREE'S STANDARD CHROMATICITY KITS

The following table provides the chromaticity bins associated with chromaticity kits for the ML family of LEDs.

Color	CCT	Kit	Chromaticity Bins
Cool White	7000 K	DT	0A, 0B, 0C, 0D, 0R, 0S, 0T, 0U, 1A, 1B, 1C, 1D, 1R, 1S, 1T, 1U
	7000 K	E0	0A, 0B, 0C, 0D
	6500 K	S1	0A, 0B, 0C, 0D, 0R, 0S, 0T, 0U, 1A, 1B, 1C, 1D, 1R, 1S, 1T, 1U, 2A, 2B, 2C, 2D, 2R, 2S, 2T, 2U, 3A, 3B, 3R, 3S
	6500 K	E1	1A, 1B, 1C, 1D
	6200 K	S0	1A, 1B, 1C, 1D, 2A, 2B, 2C, 2D
	6000 K	DV	1A, 1B, 1C, 1D, 1R, 1S, 1T, 1U, 2A, 2B, 2C, 2D, 2R, 2S, 2T, 2U
	5700 K	E2	2A, 2B, 2C, 2D
	5500 K	DY	2A, 2B, 2C, 2D, 2R, 2S, 2T, 2U, 3A, 3B, 3C, 3D, 3R, 3S, 3T, 3U
	5000 K	DZ	2C, 2D, 2T, 2U, 3A, 3B, 3C, 3D, 3R, 3S, 3T, 3U, 4A, 4B, 4R, 4S
	5000 K	A1	3A, 3B, 3C, 3D, 4A, 4B
	5000 K	E3	3A, 3B, 3C, 3D
	4750 K	F4	3C, 3D, 4A, 4B
	4750 K	A2	3C, 3D, 4A, 4B, 4C, 4D
	4500 K	E4	4A, 4B, 4C, 4D
	Warm White	4300 K	A3
4250 K		F5	4C, 4D, 5A1, 5A2, 5A3, 5A4, 5B1, 5B2, 5B3, 5B4
4000 K		E5	5A1, 5A2, 5A3, 5A4, 5B1, 5B2, 5B3, 5B4, 5C1, 5C2, 5C3, 5C4, 5D1, 5D2, 5D3, 5D4
4000 K		Z5	5A3, 5B4, 5C1, 5D2
4000 K		A4	4C, 4D, 5A1, 5A2, 5A3, 5A4, 5B1, 5B2, 5B3, 5B4, 5C1, 5C2, 5C3, 5C4, 5D1, 5D2, 5D3, 5D4
3750 K		A5	5A1, 5A2, 5A3, 5A4, 5B1, 5B2, 5B3, 5B4, 5C1, 5C2, 5C3, 5C4, 5D1, 5D2, 5D3, 5D4, 6A1, 6A2, 6A3, 6A4, 6B1, 6B2, 6B3, 6B4
3750 K		F6	5C1, 5C2, 5C3, 5C4, 5D1, 5D2, 5D3, 5D4, 6A1, 6A2, 6A3, 6A4, 6B1, 6B2, 6B3, 6B4
3500 K		E6	6A1, 6A2, 6A3, 6A4, 6B1, 6B2, 6B3, 6B4, 6C1, 6C2, 6C3, 6C4, 6D1, 6D2, 6D3, 6D4
3500 K		Z6	6A3, 6B4, 6C1, 6D2
3500 K		A6	5C1, 5C2, 5C3, 5C4, 5D1, 5D2, 5D3, 5D4, 6A1, 6A2, 6A3, 6A4, 6B1, 6B2, 6B3, 6B4, 6C1, 6C2, 6C3, 6C4, 6D1, 6D2, 6D3, 6D4
3250 K		A7	6A1, 6A2, 6A3, 6A4, 6B1, 6B2, 6B3, 6B4, 6C1, 6C2, 6C3, 6C4, 6D1, 6D2, 6D3, 6D4, 7A1, 7A2, 7A3, 7A4, 7B1, 7B2, 7B3, 7B4
3250 K		F7	6C1, 6C2, 6C3, 6C4, 6D1, 6D2, 6D3, 6D4, 7A1, 7A2, 7A3, 7A4, 7B1, 7B2, 7B3, 7B4
3000 K		E7	7A1, 7A2, 7A3, 7A4, 7B1, 7B2, 7B3, 7B4, 7C1, 7C2, 7C3, 7C4, 7D1, 7D2, 7D3, 7D4
3000 K		Z7	7A3, 7B4, 7C1, 7D2
3000 K		A8	6C1, 6C2, 6C3, 6C4, 6D1, 6D2, 6D3, 6D4, 7A1, 7A2, 7A3, 7A4, 7B1, 7B2, 7B3, 7B4, 7C1, 7C2, 7C3, 7C4, 7D1, 7D2, 7D3, 7D4
2850 K		A9	7A1, 7A2, 7A3, 7A4, 7B1, 7B2, 7B3, 7B4, 7C1, 7C2, 7C3, 7C4, 7D1, 7D2, 7D3, 7D4, 8A1, 8A2, 8A3, 8A4, 8B1, 8B2, 8B3, 8B4
2850 K		F8	7C1, 7C2, 7C3, 7C4, 7D1, 7D2, 7D3, 7D4, 8A1, 8A2, 8A3, 8A4, 8B1, 8B2, 8B3, 8B4
2700 K		E8	8A1, 8A2, 8A3, 8A4, 8B1, 8B2, 8B3, 8B4, 8C1, 8C2, 8C3, 8C4, 8D1, 8D2, 8D3, 8D4
2700 K		Z8	8A3, 8B4, 8C1, 8D2
2700 K		AA	7C1, 7C2, 7C3, 7C4, 7D1, 7D2, 7D3, 7D4, 8A1, 8A2, 8A3, 8A4, 8B1, 8B2, 8B3, 8B4, 8C1, 8C2, 8C3, 8C4, 8D1, 8D2, 8D3, 8D4
2200 K	EA	AA1, AA2, AA3, AA4, AB1, AB2, AB3, AB4, AC1, AC2, AC3, AC4, AD1, AD2, AD3, AD4	

The following tables of order codes list flux minimums and chromaticity regions for the various categories of XLamp ML LEDs. Kit numbers completely describe an order code's chromaticity regions and luminous flux range. For other flux and chromaticity combinations, contact Cree or an authorized distributor.

**STANDARD ORDER CODES AND BINS (ML-B COOL WHITE, T<sub>j</sub> = 25 °C)**

XLamp ML-B Standard Kit Codes - White						
Chromaticity		Minimum Luminous Flux (lm) @ 80 mA*		Order Codes		
Kit	CCT	Code	Flux (lm)	Typical CRI (75)	80 CRI Minimum	
ANSI Cool White (4500 K - 8300 K)						
DT	7000 K	J0	23.5	MLBAWT-A1-0000-000WDT		
E0				MLBAWT-A1-0000-000WE0		
51	6500 K			MLBAWT-A1-0000-000W51		
E1				MLBAWT-A1-0000-000WE1		
50	6200 K			MLBAWT-A1-0000-000W50		
DV	6000 K			MLBAWT-A1-0000-000WDV		
E2	5750 K			MLBAWT-A1-0000-000WE2		
DY	5500 K			MLBAWT-A1-0000-000WDY		
DZ	5000 K			MLBAWT-A1-0000-000WDZ		
A1				MLBAWT-A1-0000-000WA1		
E3				MLBAWT-A1-0000-000WE3		
F4				MLBAWT-A1-0000-000WF4		
A2	4750K			MLBAWT-A1-0000-000WA2		
E4	4500K			MLBAWT-A1-0000-000WE4		

**STANDARD ORDER CODES AND BINS (ML-B WARM WHITE, T<sub>j</sub> = 25 °C)**

XLamp ML-B Standard Kit Codes - White							
Chromaticity		Minimum Luminous Flux (lm) @ 80 mA*		Order Codes			
Kit	CCT	Code	Flux (lm)	Typical CRI (80)	80 CRI Minimum	85 CRI Minimum	90 CRI Minimum
ANSI Warm White (2600 K - 4300 K)							
A3	4300 K	J0	23.5	MLBAWT-A1-0000-000WA3			
		H0	18.1	MLBAWT-A1-0000-000VA3			
F5	4250 K	J0	23.5	MLBAWT-A1-0000-000WF5			
		H0	18.1	MLBAWT-A1-0000-000VF5			
E5	4000 K	J0	23.5	MLBAWT-A1-0000-000WE5	MLBAWT-H1-0000-000WE5		
		H0	18.1	MLBAWT-A1-0000-000VE5	MLBAWT-H1-0000-000VE5	MLBAWT-P1-0000-000VE5	MLBAWT-U1-0000-000VE5
Z5		J0	23.5	MLBAWT-A1-0000-000WZ5	MLBAWT-H1-0000-000WZ5		
		H0	18.1	MLBAWT-A1-0000-000VZ5	MLBAWT-H1-0000-000VZ5	MLBAWT-P1-0000-000VZ5	MLBAWT-U1-0000-000VZ5
A4		J0	23.5	MLBAWT-A1-0000-000WA4			
		H0	18.1	MLBAWT-A1-0000-000VA4			

**\* Notes:**

- Cree maintains a tolerance of ±7% on flux and power measurements, ±0.005 on chromaticity (CCx, CCy) measurements and ±2 on CRI measurements.
- Typical CRI for Cool White order codes is 75; Typical CRI for Warm White order codes is 80.
- Cree XLamp order codes specify only a minimum flux bin and not a maximum. Cree may ship reels in flux bins higher than the minimum specified by the order code without advance notice. Shipments will always adhere to the chromaticity bin restrictions specified by the order code.

XLamp ML-B Standard Kit Codes - White							
Chromaticity		Minimum Luminous Flux (lm) @ 80 mA*		Order Codes			
Kit	CCT	Code	Flux (lm)	Typical CRI (80)	80 CRI Minimum	85 CRI Minimum	90 CRI Minimum
A5	3750 K	J0	23.5	MLBAWT-A1-0000-000WA5			
		H0	18.1	MLBAWT-A1-0000-000VA5	MLBAWT-H1-0000-000VA5	MLBAWT-P1-0000-000VA5	MLBAWT-U1-0000-000VA5
		G0	13.9				MLBAWT-U1-0000-000UA5
F6		J0	23.5	MLBAWT-A1-0000-000WF6			
		H0	18.1	MLBAWT-A1-0000-000VF6	MLBAWT-H1-0000-000VF6	MLBAWT-P1-0000-000VF6	MLBAWT-U1-0000-000VF6
		G0	13.9				MLBAWT-U1-0000-000UF6
E6	3500 K	J0	23.5	MLBAWT-A1-0000-000WE6			
		H0	18.1	MLBAWT-A1-0000-000VE6	MLBAWT-H1-0000-000VE6	MLBAWT-P1-0000-000VE6	MLBAWT-U1-0000-000VE6
		G0	13.9				MLBAWT-U1-0000-000UE6
Z6		J0	23.5	MLBAWT-A1-0000-000WZ6			
		H0	18.1	MLBAWT-A1-0000-000VZ6	MLBAWT-H1-0000-000VZ6	MLBAWT-P1-0000-000VZ6	MLBAWT-U1-0000-000VZ6
		G0	13.9				MLBAWT-U1-0000-000UZ6
A6	3250 K	J0	23.5	MLBAWT-A1-0000-000WA6			
		H0	18.1	MLBAWT-A1-0000-000VA6	MLBAWT-H1-0000-000VA6	MLBAWT-P1-0000-000VA6	MLBAWT-U1-0000-000VA6
		G0	13.9				MLBAWT-U1-0000-000UA6
A7		J0	23.5	MLBAWT-A1-0000-000WA7			
		H0	18.1	MLBAWT-A1-0000-000VA7	MLBAWT-H1-0000-000VA7	MLBAWT-P1-0000-000VA7	MLBAWT-U1-0000-000VA7
		G0	13.9			MLBAWT-P1-0000-000UA7	MLBAWT-U1-0000-000UA7
F7	J0	23.5	MLBAWT-A1-0000-000WF7				
	H0	18.1	MLBAWT-A1-0000-000VF7	MLBAWT-H1-0000-000VF7	MLBAWT-P1-0000-000VF7	MLBAWT-U1-0000-000VF7	
	G0	13.9			MLBAWT-P1-0000-000UF7	MLBAWT-U1-0000-000UF7	
E7	3000 K	J0	23.5	MLBAWT-A1-0000-000WE7			
		H0	18.1	MLBAWT-A1-0000-000VE7	MLBAWT-H1-0000-000VE7	MLBAWT-P1-0000-000VE7	MLBAWT-U1-0000-000VE7
		G0	13.9			MLBAWT-P1-0000-000UE7	MLBAWT-U1-0000-000UE7
Z7		J0	23.5	MLBAWT-A1-0000-000WZ7			
		H0	18.1	MLBAWT-A1-0000-000VZ7	MLBAWT-H1-0000-000VZ7	MLBAWT-P1-0000-000VZ7	MLBAWT-U1-0000-000VZ7
		G0	13.9			MLBAWT-P1-0000-000UZ7	MLBAWT-U1-0000-000UZ7
A8	2850 K	J0	23.5	MLBAWT-A1-0000-000WA8			
		H0	18.1	MLBAWT-A1-0000-000VA8	MLBAWT-H1-0000-000VA8	MLBAWT-P1-0000-000VA8	MLBAWT-U1-0000-000VA8
		G0	13.9			MLBAWT-P1-0000-000UA8	MLBAWT-U1-0000-000UA8
A9		H0	18.1	MLBAWT-A1-0000-000VA9	MLBAWT-H1-0000-000VA9	MLBAWT-P1-0000-000VA9	MLBAWT-U1-0000-000VA9
		G0	13.9			MLBAWT-P1-0000-000UA9	MLBAWT-U1-0000-000UA9
F8		H0	18.1	MLBAWT-A1-0000-000VF8	MLBAWT-H1-0000-000VF8	MLBAWT-P1-0000-000VF8	MLBAWT-U1-0000-000VF8
	G0	13.9			MLBAWT-P1-0000-000UF8	MLBAWT-U1-0000-000UF8	

\* Notes:

- Cree maintains a tolerance of ±7% on flux and power measurements, ±0.005 on chromaticity (CCx, CCy) measurements and ±2 on CRI measurements.
- Typical CRI for Cool White order codes is 75; Typical CRI for Warm White order codes is 80.
- Cree XLamp order codes specify only a minimum flux bin and not a maximum. Cree may ship reels in flux bins higher than the minimum specified by the order code without advance notice. Shipments will always adhere to the chromaticity bin restrictions specified by the order code.

XLamp ML-B Standard Kit Codes - White							
Chromaticity		Minimum Luminous Flux (lm) @ 80 mA*		Order Codes			
Kit	CCT	Code	Flux (lm)	Typical CRI (80)	80 CRI Minimum	85 CRI Minimum	90 CRI Minimum
E8	2700 K	H0	18.1	MLBAWT-A1-0000-000VE8	MLBAWT-H1-0000-000VE8	MLBAWT-P1-0000-000VE8	MLBAWT-U1-0000-000VE8
		G0	13.9			MLBAWT-P1-0000-000UE8	MLBAWT-U1-0000-000UE8
Z8		H0	18.1	MLBAWT-A1-0000-000VZ8	MLBAWT-H1-0000-000VZ8	MLBAWT-P1-0000-000VZ8	MLBAWT-U1-0000-000VZ8
		G0	13.9			MLBAWT-P1-0000-000UZ8	MLBAWT-U1-0000-000UZ8
AA		H0	18.1	MLBAWT-A1-0000-000VAA	MLBAWT-H1-0000-000VAA	MLBAWT-P1-0000-000VAA	MLBAWT-U1-0000-000VAA
		G0	13.9			MLBAWT-P1-0000-000UAA	MLBAWT-U1-0000-000UAA
EA	2200 K	G0	13.9	MLBAWT-A1-0000-000UEA			
		F0	10.7	MLBAWT-A1-0000-000TEA			

### STANDARD ORDER CODES AND BINS (ML-C PARALLEL, COOL WHITE, T<sub>j</sub> = 25 °C)

XLamp ML-C Parallel, Standard Kit Codes - White						
Chromaticity		Minimum Luminous Flux (lm) @ 100 mA*		Order Codes		
Kit	CCT	Code	Flux (lm)	Typical CRI (75)	80 CRI Minimum	
ANSI Cool White (4500 K - 8300 K)						
DT	7000 K	K3	35.2	MLCAWT-A1-0000-0001DT		
		K2	30.6	MLCAWT-A1-0000-0000DT		
		J3	26.8	MLCAWT-A1-0000-000XDT		
E0		K3	35.2	MLCAWT-A1-0000-0001E0		
		K2	30.6	MLCAWT-A1-0000-0000E0		
		J3	26.8	MLCAWT-A1-0000-000XE0		
51	6500 K	K3	35.2	MLCAWT-A1-0000-000151		
		K2	30.6	MLCAWT-A1-0000-000051		
		J3	26.8	MLCAWT-A1-0000-000X51		
E1		K3	35.2	MLCAWT-A1-0000-0001E1		MLCAWT-H1-0000-0000E1
		K2	30.6	MLCAWT-A1-0000-0000E1		
		J3	26.8	MLCAWT-A1-0000-000XE1		

\* Notes:

- Cree maintains a tolerance of ±7% on flux and power measurements, ±0.005 on chromaticity (CCx, CCy) measurements and ±2 on CRI measurements.
- Typical CRI for Cool White order codes is 75; Typical CRI for Warm White order codes is 80.
- Cree XLamp order codes specify only a minimum flux bin and not a maximum. Cree may ship reels in flux bins higher than the minimum specified by the order code without advance notice. Shipments will always adhere to the chromaticity bin restrictions specified by the order code.



XLamp ML-C Parallel, Standard Kit Codes - White					
Chromaticity		Minimum Luminous Flux (lm) @ 100 mA*		Order Codes	
Kit	CCT	Code	Flux (lm)	Typical CRI (75)	80 CRI Minimum
50	6200 K	K3	35.2	MLCAWT-A1-0000-000150	
		K2	30.6	MLCAWT-A1-0000-000050	
		J3	26.8	MLCAWT-A1-0000-000X50	
DV	6000 K	K3	35.2	MLCAWT-A1-0000-0001DV	
		K2	30.6	MLCAWT-A1-0000-0000DV	
		J3	26.8	MLCAWT-A1-0000-000XDV	
E2	5750 K	K3	35.2	MLCAWT-A1-0000-0001E2	
		K2	30.6	MLCAWT-A1-0000-0000E2	
		J3	26.8	MLCAWT-A1-0000-000XE2	
DY	5500 K	K3	35.2	MLCAWT-A1-0000-0001DY	
		K2	30.6	MLCAWT-A1-0000-0000DY	
		J3	26.8	MLCAWT-A1-0000-000XDY	
DZ	5000 K	K3	35.2	MLCAWT-A1-0000-0001DZ	
		K2	30.6	MLCAWT-A1-0000-0000DZ	
		J3	26.8	MLCAWT-A1-0000-000XDZ	
A1	5000 K	K3	35.2	MLCAWT-A1-0000-0001A1	
		K2	30.6	MLCAWT-A1-0000-0000A1	
		J3	26.8	MLCAWT-A1-0000-000XA1	
E3	5000 K	K3	35.2	MLCAWT-A1-0000-0001E3	
		K2	30.6	MLCAWT-A1-0000-0000E3	MLCAWT-H1-0000-0000E3
		J3	26.8	MLCAWT-A1-0000-000XE3	MLCAWT-H1-0000-000XE3
F4	4750 K	K3	35.2	MLCAWT-A1-0000-0001F4	
		K2	30.6	MLCAWT-A1-0000-0000F4	
		J3	26.8	MLCAWT-A1-0000-000XF4	
A2	4750 K	K3	35.2	MLCAWT-A1-0000-0001A2	
		K2	30.6	MLCAWT-A1-0000-0000A2	
		J3	26.8	MLCAWT-A1-0000-000XA2	
E4	4500 K	K3	35.2	MLCAWT-A1-0000-0001E4	
		K2	30.6	MLCAWT-A1-0000-0000E4	
		J3	26.8	MLCAWT-A1-0000-000XE4	

\* Notes:

- Cree maintains a tolerance of  $\pm 7\%$  on flux and power measurements,  $\pm 0.005$  on chromaticity (CCx, CCy) measurements and  $\pm 2$  on CRI measurements.
- Typical CRI for Cool White order codes is 75; Typical CRI for Warm White order codes is 80.
- Cree XLamp order codes specify only a minimum flux bin and not a maximum. Cree may ship reels in flux bins higher than the minimum specified by the order code without advance notice. Shipments will always adhere to the chromaticity bin restrictions specified by the order code.

**STANDARD ORDER CODES AND BINS (ML-C PARALLEL, WARM WHITE, T<sub>j</sub> = 25 °C)**

XLamp ML-C Parallel, Standard Kit Codes - White										
Chromaticity		Minimum Luminous Flux (lm) @ 100 mA*		Order Codes						
Kit	CCT	Code	Flux (lm)	Typical CRI (80)	80 CRI Minimum	85 CRI Minimum	90 CRI Minimum			
ANSI Warm White (2600 K – 4300 K)										
A3	4300 K	K2	30.6	MLCAWT-A1-0000-0000A3						
		J3	26.8	MLCAWT-A1-0000-000XA3						
F5	4250 K	K2	30.6	MLCAWT-A1-0000-0000F5						
		J3	26.8	MLCAWT-A1-0000-000XF5						
E5	4000 K	K2	30.6	MLCAWT-A1-0000-0000E5				MLCAWT-H1-0000-0000E5		
		J3	26.8	MLCAWT-A1-0000-000XE5				MLCAWT-H1-0000-000XE5	MLCAWT-P1-0000-000XE5	
		J2	23.5					MLCAWT-H1-0000-000WE5	MLCAWT-P1-0000-000WE5	MLCAWT-U1-0000-000WE5
		H0	18.1							MLCAWT-U1-0000-000VE5
Z5		K2	30.6	MLCAWT-A1-0000-0000Z5	MLCAWT-H1-0000-0000Z5					
		J3	26.8	MLCAWT-A1-0000-000XZ5	MLCAWT-H1-0000-000XZ5	MLCAWT-P1-0000-000XZ5				
		J2	23.5		MLCAWT-H1-0000-000WZ5	MLCAWT-P1-0000-000WZ5	MLCAWT-U1-0000-000WZ5			
		H0	18.1				MLCAWT-U1-0000-000VZ5			
A4		K2	30.6	MLCAWT-A1-0000-0000A4						
		J3	26.8	MLCAWT-A1-0000-000XA4						
A5		K2	30.6	MLCAWT-A1-0000-0000A5	MLCAWT-H1-0000-0000A5					
		J3	26.8	MLCAWT-A1-0000-000XA5	MLCAWT-H1-0000-000XA5	MLCAWT-P1-0000-000XA5				
		J2	23.5		MLCAWT-H1-0000-000WA5	MLCAWT-P1-0000-000WA5	MLCAWT-U1-0000-000WA5			
		H0	18.1			MLCAWT-P1-0000-000VA5	MLCAWT-U1-0000-000VA5			
F6		K2	30.6	MLCAWT-A1-0000-0000F6	MLCAWT-H1-0000-0000F6					
		J3	26.8	MLCAWT-A1-0000-000XF6	MLCAWT-H1-0000-000XF6	MLCAWT-P1-0000-000XF6				
	J2	23.5		MLCAWT-H1-0000-000WF6	MLCAWT-P1-0000-000WF6	MLCAWT-U1-0000-000WF6				
	H0	18.1			MLCAWT-P1-0000-000VF6	MLCAWT-U1-0000-000VF6				
E6	3500 K	K2	30.6	MLCAWT-A1-0000-0000E6	MLCAWT-H1-0000-0000E6					
		J3	26.8	MLCAWT-A1-0000-000XE6	MLCAWT-H1-0000-000XE6	MLCAWT-P1-0000-000XE6				
		J2	23.5		MLCAWT-H1-0000-000WE6	MLCAWT-P1-0000-000WE6	MLCAWT-U1-0000-000WE6			
		H0	18.1			MLCAWT-P1-0000-000VE6	MLCAWT-U1-0000-000VE6			
Z6		K2	30.6	MLCAWT-A1-0000-0000Z6	MLCAWT-H1-0000-0000Z6					
		J3	26.8	MLCAWT-A1-0000-000XZ6	MLCAWT-H1-0000-000XZ6	MLCAWT-P1-0000-000XZ6				
		J2	23.5		MLCAWT-H1-0000-000WZ6	MLCAWT-P1-0000-000WZ6	MLCAWT-U1-0000-000WZ6			
		H0	18.1			MLCAWT-P1-0000-000VZ6	MLCAWT-U1-0000-000VZ6			
A6	K2	30.6	MLCAWT-A1-0000-0000A6	MLCAWT-H1-0000-0000A6						
	J3	26.8	MLCAWT-A1-0000-000XA6	MLCAWT-H1-0000-000XA6	MLCAWT-P1-0000-000XA6					
	J2	23.5		MLCAWT-H1-0000-000WA6	MLCAWT-P1-0000-000WA6	MLCAWT-U1-0000-000WA6				
	H0	18.1			MLCAWT-P1-0000-000VA6	MLCAWT-U1-0000-000VA6				

**\* Notes:**

- Cree maintains a tolerance of ±7% on flux and power measurements, ±0.005 on chromaticity (CCx, CCy) measurements and ±2 on CRI measurements.
- Typical CRI for Cool White order codes is 75; Typical CRI for Warm White order codes is 80.
- Cree XLamp order codes specify only a minimum flux bin and not a maximum. Cree may ship reels in flux bins higher than the minimum specified by the order code without advance notice. Shipments will always adhere to the chromaticity bin restrictions specified by the order code.

XLamp ML-C Parallel, Standard Kit Codes - White							
Chromaticity		Minimum Luminous Flux (lm) @ 100 mA*		Order Codes			
Kit	CCT	Code	Flux (lm)	Typical CRI (80)	80 CRI Minimum	85 CRI Minimum	90 CRI Minimum
A7	3250 K	K2	30.6	MLCAWT-A1-0000-0000A7	MLCAWT-H1-0000-0000A7		
		J3	26.8	MLCAWT-A1-0000-000XA7	MLCAWT-H1-0000-000XA7		
		J2	23.5	MLCAWT-A1-0000-000WA7	MLCAWT-H1-0000-000WA7	MLCAWT-P1-0000-000WA7	MLCAWT-U1-0000-000WA7
		H0	18.1		MLCAWT-H1-0000-000VA7	MLCAWT-P1-0000-000VA7	MLCAWT-U1-0000-000VA7
		K2	30.6	MLCAWT-A1-0000-0000F7	MLCAWT-H1-0000-0000F7		
		J3	26.8	MLCAWT-A1-0000-000XF7	MLCAWT-H1-0000-000XF7		
		J2	23.5	MLCAWT-A1-0000-000WF7	MLCAWT-H1-0000-000WF7	MLCAWT-P1-0000-000WF7	MLCAWT-U1-0000-000WF7
		H0	18.1		MLCAWT-H1-0000-000VF7	MLCAWT-P1-0000-000VF7	MLCAWT-U1-0000-000VF7
E7	3000 K	K2	30.6	MLCAWT-A1-0000-0000E7	MLCAWT-H1-0000-0000E7		
		J3	26.8	MLCAWT-A1-0000-000XE7	MLCAWT-H1-0000-000XE7		
		J2	23.5	MLCAWT-A1-0000-000WE7	MLCAWT-H1-0000-000WE7	MLCAWT-P1-0000-000WE7	MLCAWT-U1-0000-000WE7
		H0	18.1		MLCAWT-H1-0000-000VE7	MLCAWT-P1-0000-000VE7	MLCAWT-U1-0000-000VE7
		K2	30.6	MLCAWT-A1-0000-0000Z7	MLCAWT-H1-0000-0000Z7		
		J3	26.8	MLCAWT-A1-0000-000XZ7	MLCAWT-H1-0000-000XZ7		
		J2	23.5	MLCAWT-A1-0000-000WZ7	MLCAWT-H1-0000-000WZ7	MLCAWT-P1-0000-000WZ7	MLCAWT-U1-0000-000WZ7
		H0	18.1		MLCAWT-H1-0000-000VZ7	MLCAWT-P1-0000-000VZ7	MLCAWT-U1-0000-000VZ7
A8	2850 K	K2	30.6	MLCAWT-A1-0000-0000A8	MLCAWT-H1-0000-0000A8		
		J3	26.8	MLCAWT-A1-0000-000XA8	MLCAWT-H1-0000-000XA8		
		J2	23.5	MLCAWT-A1-0000-000WA8	MLCAWT-H1-0000-000WA8	MLCAWT-P1-0000-000WA8	MLCAWT-U1-0000-000WA8
		H0	18.1		MLCAWT-H1-0000-000VA8	MLCAWT-P1-0000-000VA8	MLCAWT-U1-0000-000VA8
A9	2700 K	J3	26.8	MLCAWT-A1-0000-000XA9	MLCAWT-H1-0000-000XA9		
		J2	23.5	MLCAWT-A1-0000-000WA9	MLCAWT-H1-0000-000WA9	MLCAWT-P1-0000-000WA9	MLCAWT-U1-0000-000WA9
		H0	18.1		MLCAWT-H1-0000-000VA9	MLCAWT-P1-0000-000VA9	MLCAWT-U1-0000-000VA9
		J3	26.8	MLCAWT-A1-0000-000XF8	MLCAWT-H1-0000-000XF8		
F8	2700 K	J2	23.5	MLCAWT-A1-0000-000WF8	MLCAWT-H1-0000-000WF8	MLCAWT-P1-0000-000WF8	MLCAWT-U1-0000-000WF8
		H0	18.1		MLCAWT-H1-0000-000VF8	MLCAWT-P1-0000-000VF8	MLCAWT-U1-0000-000VF8
		J3	26.8	MLCAWT-A1-0000-000XE8	MLCAWT-H1-0000-000XE8		
		J2	23.5	MLCAWT-A1-0000-000WE8	MLCAWT-H1-0000-000WE8	MLCAWT-P1-0000-000WE8	MLCAWT-U1-0000-000WE8
E8	2700 K	H0	18.1		MLCAWT-H1-0000-000VE8	MLCAWT-P1-0000-000VE8	MLCAWT-U1-0000-000VE8
		J3	26.8	MLCAWT-A1-0000-000XZ8	MLCAWT-H1-0000-000XZ8		
		J2	23.5	MLCAWT-A1-0000-000WZ8	MLCAWT-H1-0000-000WZ8	MLCAWT-P1-0000-000WZ8	MLCAWT-U1-0000-000WZ8
		H0	18.1		MLCAWT-H1-0000-000VZ8	MLCAWT-P1-0000-000VZ8	MLCAWT-U1-0000-000VZ8
AA	2700 K	J3	26.8	MLCAWT-A1-0000-000XAA	MLCAWT-H1-0000-000XAA		
		J2	23.5	MLCAWT-A1-0000-000WAA	MLCAWT-H1-0000-000WAA	MLCAWT-P1-0000-000WAA	MLCAWT-U1-0000-000WAA
		H0	18.1		MLCAWT-H1-0000-000VAA	MLCAWT-P1-0000-000VAA	MLCAWT-U1-0000-000VAA

\* Notes:

- Cree maintains a tolerance of ±7% on flux and power measurements, ±0.005 on chromaticity (CCx, CCy) measurements and ±2 on CRI measurements.
- Typical CRI for Cool White order codes is 75; Typical CRI for Warm White order codes is 80.
- Cree XLamp order codes specify only a minimum flux bin and not a maximum. Cree may ship reels in flux bins higher than the minimum specified by the order code without advance notice. Shipments will always adhere to the chromaticity bin restrictions specified by the order code.

**STANDARD ORDER CODES AND BINS (ML-C SERIES, COOL WHITE, T<sub>j</sub> = 25 °C)**

XLamp ML-C Series, Standard Kit Codes - White						
Chromaticity		Minimum Luminous Flux (lm) @ 50 mA*		Order Codes		
Kit	CCT	Code	Flux (lm)	Typical CRI (75)	80 CRI Minimum	
ANSI Cool White (4500 K – 8300 K)						
DT	7000 K	K3	35.2	MLCSWT-A1-0000-0001DT		
		K2	30.6	MLCSWT-A1-0000-0000DT		
		J3	26.8	MLCSWT-A1-0000-000XDT		
E0		K3	35.2	MLCSWT-A1-0000-0001E0		
		K2	30.6	MLCSWT-A1-0000-0000E0		
		J3	26.8	MLCSWT-A1-0000-000XE0		
51	6500 K	K3	35.2	MLCSWT-A1-0000-000151		
		K2	30.6	MLCSWT-A1-0000-000051		
		J3	26.8	MLCSWT-A1-0000-000X51		
E1		K3	35.2	MLCSWT-A1-0000-0001E1		MLCSWT-H1-0000-0000E1
		K2	30.6	MLCSWT-A1-0000-0000E1		MLCSWT-H1-0000-0000E1
		J3	26.8	MLCSWT-A1-0000-000XE1		MLCSWT-H1-0000-000XE1
50	6200 K	K3	35.2	MLCSWT-A1-0000-000150		
		K2	30.6	MLCSWT-A1-0000-000050		
		J3	26.8	MLCSWT-A1-0000-000X50		
DV		6000 K	K3	35.2	MLCSWT-A1-0000-0001DV	
			K2	30.6	MLCSWT-A1-0000-0000DV	
			J3	26.8	MLCSWT-A1-0000-000XDV	
E2	5750 K		K3	35.2	MLCSWT-A1-0000-0001E2	
			K2	30.6	MLCSWT-A1-0000-0000E2	
			J3	26.8	MLCSWT-A1-0000-000XE2	
DY		5500 K	K3	35.2	MLCSWT-A1-0000-0001DY	
			K2	30.6	MLCSWT-A1-0000-0000DY	
			J3	26.8	MLCSWT-A1-0000-000XDY	
DZ	5000 K		K3	35.2	MLCSWT-A1-0000-0001DZ	
			K2	30.6	MLCSWT-A1-0000-0000DZ	
			J3	26.8	MLCSWT-A1-0000-000XDZ	
A1		5000 K	K3	35.2	MLCSWT-A1-0000-0001A1	
			K2	30.6	MLCSWT-A1-0000-0000A1	
			J3	26.8	MLCSWT-A1-0000-000XA1	
E3	5000 K		K3	35.2	MLCSWT-A1-0000-0001E3	MLCSWT-H1-0000-0000E3
			K2	30.6	MLCSWT-A1-0000-0000E3	MLCSWT-H1-0000-0000E3
			J3	26.8	MLCSWT-A1-0000-000XE3	MLCSWT-H1-0000-000XE3

**\* Notes:**

- Cree maintains a tolerance of ±7% on flux and power measurements, ±0.005 on chromaticity (CCx, CCy) measurements and ±2 on CRI measurements.
- Typical CRI for Cool White order codes is 75; Typical CRI for Warm White order codes is 80.
- Cree XLamp order codes specify only a minimum flux bin and not a maximum. Cree may ship reels in flux bins higher than the minimum specified by the order code without advance notice. Shipments will always adhere to the chromaticity bin restrictions specified by the order code.

XLamp ML-C Series, Standard Kit Codes - White						
Chromaticity		Minimum Luminous Flux (lm) @ 50 mA*		Order Codes		
Kit	CCT	Code	Flux (lm)	Typical CRI (75)		80 CRI Minimum
F4	4750 K	K3	35.2	MLCSWT-A1-0000-0001F4		
		K2	30.6	MLCSWT-A1-0000-0000F4		
		J3	26.8	MLCSWT-A1-0000-000XF4		
A2		K3	35.2	MLCSWT-A1-0000-0001A2		
		K2	30.6	MLCSWT-A1-0000-0000A2		
		J3	26.8	MLCSWT-A1-0000-000XA2		
E4	4500 K	K3	35.2	MLCSWT-A1-0000-0001E4		
		K2	30.6	MLCSWT-A1-0000-0000E4		
		J3	26.8	MLCSWT-A1-0000-000XE4		

**STANDARD ORDER CODES AND BINS (ML-C SERIES, WARM WHITE, T<sub>j</sub> = 25 °C)**

XLamp ML-C Series, Standard Kit Codes - White								
Chromaticity		Minimum Luminous Flux (lm) @ 50 mA*		Order Codes				
Kit	CCT	Code	Flux (lm)	Typical CRI (80)	80 CRI Minimum	85 CRI Minimum	90 CRI Minimum	
ANSI Warm White (2600 K – 4300 K)								
A3	4300 K	K2	30.6	MLCSWT-A1-0000-0000A3				
		J3	26.8	MLCSWT-A1-0000-000XA3				
F5	4250 K	K2	30.6	MLCSWT-A1-0000-0000F5				
		J3	26.8	MLCSWT-A1-0000-000XF5				
E5	4000 K	K2	30.6	MLCSWT-A1-0000-0000E5	MLCSWT-H1-0000-0000E5			
		J3	26.8	MLCSWT-A1-0000-000XE5	MLCSWT-H1-0000-000XE5	MLCSWT-P1-0000-000XE5		
		J2	23.5		MLCSWT-H1-0000-000WE5	MLCSWT-P1-0000-000WE5	MLCSWT-U1-0000-000WE5	
		H0	18.1				MLCSWT-U1-0000-000VE5	
Z5		K2	30.6	MLCSWT-A1-0000-0000Z5	MLCSWT-H1-0000-0000Z5			
		J3	26.8	MLCSWT-A1-0000-000XZ5	MLCSWT-H1-0000-000XZ5	MLCSWT-P1-0000-000XZ5		
		J2	23.5		MLCSWT-H1-0000-000WZ5	MLCSWT-P1-0000-000WZ5	MLCSWT-U1-0000-000WZ5	
		H0	18.1				MLCSWT-U1-0000-000VZ5	
A4			K2	30.6	MLCSWT-A1-0000-0000A4			
			J3	26.8	MLCSWT-A1-0000-000XA4			

**\* Notes:**

- Cree maintains a tolerance of ±7% on flux and power measurements, ±0.005 on chromaticity (CCx, CCy) measurements and ±2 on CRI measurements.
- Typical CRI for Cool White order codes is 75; Typical CRI for Warm White order codes is 80.
- Cree XLamp order codes specify only a minimum flux bin and not a maximum. Cree may ship reels in flux bins higher than the minimum specified by the order code without advance notice. Shipments will always adhere to the chromaticity bin restrictions specified by the order code.

XLamp ML-C Series, Standard Kit Codes - White							
Chromaticity		Minimum Luminous Flux (lm) @ 50 mA*		Order Codes			
Kit	CCT	Code	Flux (lm)	Typical CRI (80)	80 CRI Minimum	85 CRI Minimum	90 CRI Minimum
A5	3750 K	K2	30.6	MLCSWT-A1-0000-0000A5	MLCSWT-H1-0000-0000A5		
		J3	26.8	MLCSWT-A1-0000-000XA5	MLCSWT-H1-0000-000XA5	MLCSWT-P1-0000-000XA5	
		J2	23.5		MLCSWT-H1-0000-000WA5	MLCSWT-P1-0000-000WA5	MLCSWT-U1-0000-000WA5
		H0	18.1			MLCSWT-P1-0000-000VA5	MLCSWT-U1-0000-000VA5
		K2	30.6	MLCSWT-A1-0000-0000F6	MLCSWT-H1-0000-0000F6		
		J3	26.8	MLCSWT-A1-0000-000XF6	MLCSWT-H1-0000-000XF6	MLCSWT-P1-0000-000XF6	
		J2	23.5		MLCSWT-H1-0000-000WF6	MLCSWT-P1-0000-000WF6	MLCSWT-U1-0000-000WF6
		H0	18.1			MLCSWT-P1-0000-000VF6	MLCSWT-U1-0000-000VF6
E6	3500 K	K2	30.6	MLCSWT-A1-0000-0000E6	MLCSWT-H1-0000-0000E6		
		J3	26.8	MLCSWT-A1-0000-000XE6	MLCSWT-H1-0000-000XE6	MLCSWT-P1-0000-000XE6	
		J2	23.5		MLCSWT-H1-0000-000WE6	MLCSWT-P1-0000-000WE6	MLCSWT-U1-0000-000WE6
		H0	18.1			MLCSWT-P1-0000-000VE6	MLCSWT-U1-0000-000VE6
		K2	30.6	MLCSWT-A1-0000-0000Z6	MLCSWT-H1-0000-0000Z6		
		J3	26.8	MLCSWT-A1-0000-000XZ6	MLCSWT-H1-0000-000XZ6	MLCSWT-P1-0000-000XZ6	
		J2	23.5		MLCSWT-H1-0000-000WZ6	MLCSWT-P1-0000-000WZ6	MLCSWT-U1-0000-000WZ6
		H0	18.1			MLCSWT-P1-0000-000VZ6	MLCSWT-U1-0000-000VZ6
A6	3500 K	K2	30.6	MLCSWT-A1-0000-0000A6	MLCSWT-H1-0000-0000A6		
		J3	26.8	MLCSWT-A1-0000-000XA6	MLCSWT-H1-0000-000XA6	MLCSWT-P1-0000-000XA6	
		J2	23.5		MLCSWT-H1-0000-000WA6	MLCSWT-P1-0000-000WA6	MLCSWT-U1-0000-000WA6
		H0	18.1			MLCSWT-P1-0000-000VA6	MLCSWT-U1-0000-000VA6
A7	3250 K	K2	30.6	MLCSWT-A1-0000-0000A7	MLCSWT-H1-0000-0000A7		
		J3	26.8	MLCSWT-A1-0000-000XA7	MLCSWT-H1-0000-000XA7		
		J2	23.5	MLCSWT-A1-0000-000WA7	MLCSWT-H1-0000-000WA7	MLCSWT-P1-0000-000WA7	MLCSWT-U1-0000-000WA7
		H0	18.1		MLCSWT-H1-0000-000VA7	MLCSWT-P1-0000-000VA7	MLCSWT-U1-0000-000VA7
F7	3250 K	K2	30.6	MLCSWT-A1-0000-0000F7	MLCSWT-H1-0000-0000F7		
		J3	26.8	MLCSWT-A1-0000-000XF7	MLCSWT-H1-0000-000XF7		
		J2	23.5	MLCSWT-A1-0000-000WF7	MLCSWT-H1-0000-000WF7	MLCSWT-P1-0000-000WF7	MLCSWT-U1-0000-000WF7
		H0	18.1		MLCSWT-H1-0000-000VF7	MLCSWT-P1-0000-000VF7	MLCSWT-U1-0000-000VF7
E7	3000 K	K2	30.6	MLCSWT-A1-0000-0000E7	MLCSWT-H1-0000-0000E7		
		J3	26.8	MLCSWT-A1-0000-000XE7	MLCSWT-H1-0000-000XE7		
		J2	23.5	MLCSWT-A1-0000-000WE7	MLCSWT-H1-0000-000WE7	MLCSWT-P1-0000-000WE7	MLCSWT-U1-0000-000WE7
		H0	18.1		MLCSWT-H1-0000-000VE7	MLCSWT-P1-0000-000VE7	MLCSWT-U1-0000-000VE7
Z7	3000 K	K2	30.6	MLCSWT-A1-0000-0000Z7	MLCSWT-H1-0000-0000Z7		
		J3	26.8	MLCSWT-A1-0000-000XZ7	MLCSWT-H1-0000-000XZ7		
		J2	23.5	MLCSWT-A1-0000-000WZ7	MLCSWT-H1-0000-000WZ7	MLCSWT-P1-0000-000WZ7	MLCSWT-U1-0000-000WZ7
		H0	18.1		MLCSWT-H1-0000-000VZ7	MLCSWT-P1-0000-000VZ7	MLCSWT-U1-0000-000VZ7
A8	3000 K	K2	30.6	MLCSWT-A1-0000-0000A8	MLCSWT-H1-0000-0000A8		
		J3	26.8	MLCSWT-A1-0000-000XA8	MLCSWT-H1-0000-000XA8		
		J2	23.5	MLCSWT-A1-0000-000WA8	MLCSWT-H1-0000-000WA8	MLCSWT-P1-0000-000WA8	MLCSWT-U1-0000-000WA8
		H0	18.1		MLCSWT-H1-0000-000VA8	MLCSWT-P1-0000-000VA8	MLCSWT-U1-0000-000VA8

\* Notes:

- Cree maintains a tolerance of ±7% on flux and power measurements, ±0.005 on chromaticity (CCx, CCy) measurements and ±2 on CRI measurements.
- Typical CRI for Cool White order codes is 75; Typical CRI for Warm White order codes is 80.
- Cree XLamp order codes specify only a minimum flux bin and not a maximum. Cree may ship reels in flux bins higher than the minimum specified by the order code without advance notice. Shipments will always adhere to the chromaticity bin restrictions specified by the order code.

XLamp ML-C Series, Standard Kit Codes - White							
Chromaticity		Minimum Luminous Flux (lm) @ 50 mA*		Order Codes			
Kit	CCT	Code	Flux (lm)	Typical CRI (80)	80 CRI Minimum	85 CRI Minimum	90 CRI Minimum
A9	2850 K	J3	26.8	MLCSWT-A1-0000-000XA9	MLCSWT-H1-0000-000XA9		
		J2	23.5	MLCSWT-A1-0000-000WA9	MLCSWT-H1-0000-000WA9	MLCSWT-P1-0000-000WA9	MLCSWT-U1-0000-000WA9
		H0	18.1		MLCSWT-H1-0000-000VA9	MLCSWT-P1-0000-000VA9	MLCSWT-U1-0000-000VA9
F8		J3	26.8	MLCSWT-A1-0000-000XF8	MLCSWT-H1-0000-000XF8		
		J2	23.5	MLCSWT-A1-0000-000WF8	MLCSWT-H1-0000-000WF8	MLCSWT-P1-0000-000WF8	MLCSWT-U1-0000-000WF8
		H0	18.1		MLCSWT-H1-0000-000VF8	MLCSWT-P1-0000-000VF8	MLCSWT-U1-0000-000VF8
E8	2700 K	J3	26.8	MLCSWT-A1-0000-000XE8	MLCSWT-H1-0000-000XE8		
		J2	23.5	MLCSWT-A1-0000-000WE8	MLCSWT-H1-0000-000WE8	MLCSWT-P1-0000-000WE8	MLCSWT-U1-0000-000WE8
		H0	18.1		MLCSWT-H1-0000-000VE8	MLCSWT-P1-0000-000VE8	MLCSWT-U1-0000-000VE8
Z8		J3	26.8	MLCSWT-A1-0000-000XZ8	MLCSWT-H1-0000-000XZ8		
		J2	23.5	MLCSWT-A1-0000-000WZ8	MLCSWT-H1-0000-000WZ8	MLCSWT-P1-0000-000WZ8	MLCSWT-U1-0000-000WZ8
		H0	18.1		MLCSWT-H1-0000-000VZ8	MLCSWT-P1-0000-000VZ8	MLCSWT-U1-0000-000VZ8
AA	J3	26.8	MLCSWT-A1-0000-000XAA	MLCSWT-H1-0000-000XAA			
	J2	23.5	MLCSWT-A1-0000-000WAA	MLCSWT-H1-0000-000WAA	MLCSWT-P1-0000-000WAA	MLCSWT-U1-0000-000WAA	
	H0	18.1		MLCSWT-H1-0000-000VAA	MLCSWT-P1-0000-000VAA	MLCSWT-U1-0000-000VAA	

### STANDARD ORDER CODES AND BINS (ML-C COLOR, T<sub>j</sub> = 25 °C)

XLamp ML-C Standard Kit Codes - Royal Blue				
Royal Blue		Minimum Radiant Flux (lm) @ 100 mA*		Order Codes
Kit	Dominant Wavelength (nm)	Code	Flux (mW)	
01	450 - 465	07	100	MLCROY-A1-0000-000201
02	450 - 460	07	100	MLCROY-A1-0000-000202
03	455 - 465	07	100	MLCROY-A1-0000-000203

**\* Notes:**

- Cree maintains a tolerance of ±7% on flux and power measurements, ±0.005 on chromaticity (CCx, CCy) measurements and ±2 on CRI measurements.
- Typical CRI for Cool White order codes is 75; Typical CRI for Warm White order codes is 80.
- Cree XLamp order codes specify only a minimum flux bin and not a maximum. Cree may ship reels in flux bins higher than the minimum specified by the order code without advance notice. Shipments will always adhere to the chromaticity bin restrictions specified by the order code.

**STANDARD ORDER CODES AND BINS (ML-E PARALLEL, COOL WHITE, T<sub>j</sub> = 25 °C)**

XLamp ML-E Parallel, Standard Kit Codes - White					
Chromaticity		Minimum Luminous Flux (lm) @ 150 mA*		Order Codes	
Kit	CCT	Code	Flux (lm)	Typical CRI (75)	80 CRI Minimum
ANSI Cool White (4500 K - 8300 K)					
DT	7000 K	N3	56.8	MLEAWT-A1-0000-0005DT	
		N2	51.7	MLEAWT-A1-0000-0004DT	
		M3	45.7	MLEAWT-A1-0000-0003DT	
E0		N3	56.8	MLEAWT-A1-0000-0005E0	
		N2	51.7	MLEAWT-A1-0000-0004E0	
		M3	45.7	MLEAWT-A1-0000-0003E0	
51	6500 K	N3	56.8	MLEAWT-A1-0000-000551	
		N2	51.7	MLEAWT-A1-0000-000451	
		M3	45.7	MLEAWT-A1-0000-000351	
E1		N3	56.8	MLEAWT-A1-0000-0005E1	
		N2	51.7	MLEAWT-A1-0000-0004E1	
		M3	45.7	MLEAWT-A1-0000-0003E1	
50	6200 K	N3	56.8	MLEAWT-A1-0000-000550	
		N2	51.7	MLEAWT-A1-0000-000450	
		M3	45.7	MLEAWT-A1-0000-000350	
DV	6000 K	N3	56.8	MLEAWT-A1-0000-0005DV	
		N2	51.7	MLEAWT-A1-0000-0004DV	
		M3	45.7	MLEAWT-A1-0000-0003DV	
E2	5750 K	N3	56.8	MLEAWT-A1-0000-0005E2	
		N2	51.7	MLEAWT-A1-0000-0004E2	
		M3	45.7	MLEAWT-A1-0000-0003E2	
DY	5500 K	N3	56.8	MLEAWT-A1-0000-0005DY	
		N2	51.7	MLEAWT-A1-0000-0004DY	
		M3	45.7	MLEAWT-A1-0000-0003DY	
DZ	5000 K	N3	56.8	MLEAWT-A1-0000-0005DZ	
		N2	51.7	MLEAWT-A1-0000-0004DZ	
		M3	45.7	MLEAWT-A1-0000-0003DZ	
A1		N2	51.7	MLEAWT-A1-0000-0004A1	
		M3	45.7	MLEAWT-A1-0000-0003A1	
		M2	39.8	MLEAWT-A1-0000-0002A1	
E3		N3	56.8	MLEAWT-A1-0000-0005E3	MLEAWT-H1-0000-0004E3
		N2	51.7	MLEAWT-A1-0000-0004E3	MLEAWT-H1-0000-0003E3
		M3	45.7	MLEAWT-A1-0000-0003E3	MLEAWT-H1-0000-0002E3
		M2	39.8	MLEAWT-A1-0000-0002E3	MLEAWT-H1-0000-0002E3

**\* Notes:**

- Cree maintains a tolerance of ±7% on flux and power measurements, ±0.005 on chromaticity (CCx, CCy) measurements and ±2 on CRI measurements.
- Typical CRI for Cool White order codes is 75; Typical CRI for Warm White order codes is 80.
- Cree XLamp order codes specify only a minimum flux bin and not a maximum. Cree may ship reels in flux bins higher than the minimum specified by the order code without advance notice. Shipments will always adhere to the chromaticity bin restrictions specified by the order code.



XLamp ML-E Parallel, Standard Kit Codes - White					
Chromaticity		Minimum Luminous Flux (lm) @ 150 mA*		Order Codes	
Kit	CCT	Code	Flux (lm)	Typical CRI (75)	80 CRI Minimum
F4	4750 K	N2	51.7	MLEAWT-A1-0000-0004F4	
		M3	45.7	MLEAWT-A1-0000-0003F4	
		M2	39.8	MLEAWT-A1-0000-0002F4	
A2		N2	51.7	MLEAWT-A1-0000-0004A2	
		M3	45.7	MLEAWT-A1-0000-0003A2	
		M2	39.8	MLEAWT-A1-0000-0002A2	
E4	4500 K	N2	51.7	MLEAWT-A1-0000-0004E4	
		M3	45.7	MLEAWT-A1-0000-0003E4	
		M2	39.8	MLEAWT-A1-0000-0002E4	

### STANDARD ORDER CODES AND BINS (ML-E PARALLEL, WARM WHITE, T<sub>j</sub> = 25 °C)

XLamp ML-E Parallel, Standard Kit Codes - White										
Chromaticity		Minimum Luminous Flux (lm) @ 150 mA*		Order Codes						
Kit	CCT	Code	Flux (lm)	Typical CRI (80)	80 CRI Minimum	85 CRI Minimum	90 CRI Minimum			
ANSI Warm White (2600 K – 4300 K)										
A3	4300 K	N2	51.7	MLEAWT-A1-0000-0004A3						
		M3	45.7	MLEAWT-A1-0000-0003A3						
		M2	39.8	MLEAWT-A1-0000-0002A3						
F5	4250 K	N2	51.7	MLEAWT-A1-0000-0004F5						
		M3	45.7	MLEAWT-A1-0000-0003F5						
		M2	39.8	MLEAWT-A1-0000-0002F5						
E5	4000 K	N2	51.7	MLEAWT-A1-0000-0004E5						
		M3	45.7	MLEAWT-A1-0000-0003E5				MLEAWT-H1-0000-0003E5	MLEAWT-P1-0000-0003E5	
		M2	39.8	MLEAWT-A1-0000-0002E5				MLEAWT-H1-0000-0002E5	MLEAWT-P1-0000-0002E5	MLEAWT-U1-0000-0002E5
		K3	35.2		MLEAWT-H1-0000-0001E5	MLEAWT-P1-0000-0001E5	MLEAWT-U1-0000-0001E5			
Z5		N2	51.7	MLEAWT-A1-0000-0004Z5						
		M3	45.7	MLEAWT-A1-0000-0003Z5	MLEAWT-H1-0000-0003Z5	MLEAWT-P1-0000-0003Z5				
		M2	39.8	MLEAWT-A1-0000-0002Z5	MLEAWT-H1-0000-0002Z5	MLEAWT-P1-0000-0002Z5	MLEAWT-U1-0000-0002Z5			
		K3	35.2		MLEAWT-H1-0000-0001Z5	MLEAWT-P1-0000-0001Z5	MLEAWT-U1-0000-0001Z5			
A4		4000 K	N2	51.7	MLEAWT-A1-0000-0004A4					
			M3	45.7	MLEAWT-A1-0000-0003A4					
			M2	39.8	MLEAWT-A1-0000-0002A4					

**\* Notes:**

- Cree maintains a tolerance of ±7% on flux and power measurements, ±0.005 on chromaticity (CCx, CCy) measurements and ±2 on CRI measurements.
- Typical CRI for Cool White order codes is 75; Typical CRI for Warm White order codes is 80.
- Cree XLamp order codes specify only a minimum flux bin and not a maximum. Cree may ship reels in flux bins higher than the minimum specified by the order code without advance notice. Shipments will always adhere to the chromaticity bin restrictions specified by the order code.

XLamp ML-E Parallel, Standard Kit Codes - White							
Chromaticity		Minimum Luminous Flux (lm) @ 150 mA*		Order Codes			
Kit	CCT	Code	Flux (lm)	Typical CRI (80)	80 CRI Minimum	85 CRI Minimum	90 CRI Minimum
A5	3750 K	M3	45.7	MLEAWT-A1-0000-0003A5			
		M2	39.8	MLEAWT-A1-0000-0002A5	MLEAWT-H1-0000-0002A5	MLEAWT-P1-0000-0002A5	MLEAWT-U1-0000-0002A5
		K3	35.2		MLEAWT-H1-0000-0001A5	MLEAWT-P1-0000-0001A5	MLEAWT-U1-0000-0001A5
M3		45.7	MLEAWT-A1-0000-0003F6				
F6		M2	39.8	MLEAWT-A1-0000-0002F6	MLEAWT-H1-0000-0002F6	MLEAWT-P1-0000-0002F6	MLEAWT-U1-0000-0002F6
		K3	35.2		MLEAWT-H1-0000-0001F6	MLEAWT-P1-0000-0001F6	MLEAWT-U1-0000-0001F6
	M3	45.7	MLEAWT-A1-0000-0003E6				
E6	3500 K	M2	39.8	MLEAWT-A1-0000-0002E6	MLEAWT-H1-0000-0002E6	MLEAWT-P1-0000-0002E6	MLEAWT-U1-0000-0002E6
		K3	35.2		MLEAWT-H1-0000-0001E6	MLEAWT-P1-0000-0001E6	MLEAWT-U1-0000-0001E6
		M3	45.7	MLEAWT-A1-0000-0003Z6			
Z6		M2	39.8	MLEAWT-A1-0000-0002Z6	MLEAWT-H1-0000-0002Z6	MLEAWT-P1-0000-0002Z6	MLEAWT-U1-0000-0002Z6
		K3	35.2		MLEAWT-H1-0000-0001Z6	MLEAWT-P1-0000-0001Z6	MLEAWT-U1-0000-0001Z6
		M3	45.7	MLEAWT-A1-0000-0003A6			
A6	M2	39.8	MLEAWT-A1-0000-0002A6	MLEAWT-H1-0000-0002A6	MLEAWT-P1-0000-0002A6	MLEAWT-U1-0000-0002A6	
	K3	35.2		MLEAWT-H1-0000-0001A6	MLEAWT-P1-0000-0001A6	MLEAWT-U1-0000-0001A6	
	M3	45.7	MLEAWT-A1-0000-0003A7				
A7	3250 K	M2	39.8	MLEAWT-A1-0000-0002A7	MLEAWT-H1-0000-0002A7	MLEAWT-P1-0000-0002A7	MLEAWT-U1-0000-0002A7
		K3	35.2	MLEAWT-A1-0000-0001A7	MLEAWT-H1-0000-0001A7	MLEAWT-P1-0000-0001A7	MLEAWT-U1-0000-0001A7
		K2	30.6		MLEAWT-H1-0000-0000A7	MLEAWT-P1-0000-0000A7	MLEAWT-U1-0000-0000A7
F7		M3	45.7	MLEAWT-A1-0000-0003F7			
		M2	39.8	MLEAWT-A1-0000-0002F7	MLEAWT-H1-0000-0002F7	MLEAWT-P1-0000-0002F7	MLEAWT-U1-0000-0002F7
		K3	35.2	MLEAWT-A1-0000-0001F7	MLEAWT-H1-0000-0001F7	MLEAWT-P1-0000-0001F7	MLEAWT-U1-0000-0001F7
E7	3000 K	K2	30.6		MLEAWT-H1-0000-0000F7	MLEAWT-P1-0000-0000F7	MLEAWT-U1-0000-0000F7
		M3	45.7	MLEAWT-A1-0000-0003E7			
		Z7	M2	39.8	MLEAWT-A1-0000-0002E7	MLEAWT-H1-0000-0002E7	MLEAWT-P1-0000-0002E7
K3			35.2	MLEAWT-A1-0000-0001E7	MLEAWT-H1-0000-0001E7	MLEAWT-P1-0000-0001E7	MLEAWT-U1-0000-0001E7
K2			30.6		MLEAWT-H1-0000-0000E7	MLEAWT-P1-0000-0000E7	MLEAWT-U1-0000-0000E7
A8		M3	45.7	MLEAWT-A1-0000-0003Z7			
	A8	M2	39.8	MLEAWT-A1-0000-0002Z7	MLEAWT-H1-0000-0002Z7	MLEAWT-P1-0000-0002Z7	MLEAWT-U1-0000-0002Z7
		K3	35.2	MLEAWT-A1-0000-0001Z7	MLEAWT-H1-0000-0001Z7	MLEAWT-P1-0000-0001Z7	MLEAWT-U1-0000-0001Z7
A8		K2	30.6		MLEAWT-H1-0000-0000Z7	MLEAWT-P1-0000-0000Z7	MLEAWT-U1-0000-0000Z7
	M3	45.7	MLEAWT-A1-0000-0003A8				
	M2	39.8	MLEAWT-A1-0000-0002A8	MLEAWT-H1-0000-0002A8	MLEAWT-P1-0000-0002A8	MLEAWT-U1-0000-0002A8	
K3	35.2	MLEAWT-A1-0000-0001A8	MLEAWT-H1-0000-0001A8	MLEAWT-P1-0000-0001A8	MLEAWT-U1-0000-0001A8		
K2	30.6		MLEAWT-H1-0000-0000A8	MLEAWT-P1-0000-0000A8	MLEAWT-U1-0000-0000A8		

\* Notes:

- Cree maintains a tolerance of ±7% on flux and power measurements, ±0.005 on chromaticity (CCx, CCy) measurements and ±2 on CRI measurements.
- Typical CRI for Cool White order codes is 75; Typical CRI for Warm White order codes is 80.
- Cree XLamp order codes specify only a minimum flux bin and not a maximum. Cree may ship reels in flux bins higher than the minimum specified by the order code without advance notice. Shipments will always adhere to the chromaticity bin restrictions specified by the order code.

XLamp ML-E Parallel, Standard Kit Codes - White							
Chromaticity		Minimum Luminous Flux (lm) @ 150 mA*		Order Codes			
Kit	CCT	Code	Flux (lm)	Typical CRI (80)	80 CRI Minimum	85 CRI Minimum	90 CRI Minimum
A9	2850 K	M2	39.8	MLEAWT-A1-0000-0002A9			
		K3	35.2	MLEAWT-A1-0000-0001A9	MLEAWT-H1-0000-0001A9	MLEAWT-P1-0000-0001A9	MLEAWT-U1-0000-0001A9
		K2	30.6		MLEAWT-H1-0000-0000A9	MLEAWT-P1-0000-0000A9	MLEAWT-U1-0000-0000A9
M2		39.8	MLEAWT-A1-0000-0002F8				
F8		K3	35.2	MLEAWT-A1-0000-0001F8	MLEAWT-H1-0000-0001F8	MLEAWT-P1-0000-0001F8	MLEAWT-U1-0000-0001F8
		K2	30.6		MLEAWT-H1-0000-0000F8	MLEAWT-P1-0000-0000F8	MLEAWT-U1-0000-0000F8
E8	2700 K	M2	39.8	MLEAWT-A1-0000-0002E8			
		K3	35.2	MLEAWT-A1-0000-0001E8	MLEAWT-H1-0000-0001E8	MLEAWT-P1-0000-0001E8	MLEAWT-U1-0000-0001E8
		K2	30.6		MLEAWT-H1-0000-0000E8	MLEAWT-P1-0000-0000E8	MLEAWT-U1-0000-0000E8
M2		39.8	MLEAWT-A1-0000-0002Z8				
Z8		K3	35.2	MLEAWT-A1-0000-0001Z8	MLEAWT-H1-0000-0001Z8	MLEAWT-P1-0000-0001Z8	MLEAWT-U1-0000-0001Z8
		K2	30.6		MLEAWT-H1-0000-0000Z8	MLEAWT-P1-0000-0000Z8	MLEAWT-U1-0000-0000Z8
AA	M2	39.8	MLEAWT-A1-0000-0002AA				
	K3	35.2	MLEAWT-A1-0000-0001AA	MLEAWT-H1-0000-0001AA	MLEAWT-P1-0000-0001AA	MLEAWT-U1-0000-0001AA	
	K2	30.6		MLEAWT-H1-0000-0000AA	MLEAWT-P1-0000-0000AA	MLEAWT-U1-0000-0000AA	

\* Notes:

- Cree maintains a tolerance of  $\pm 7\%$  on flux and power measurements,  $\pm 0.005$  on chromaticity (CCx, CCy) measurements and  $\pm 2$  on CRI measurements.
- Typical CRI for Cool White order codes is 75; Typical CRI for Warm White order codes is 80.
- Cree XLamp order codes specify only a minimum flux bin and not a maximum. Cree may ship reels in flux bins higher than the minimum specified by the order code without advance notice. Shipments will always adhere to the chromaticity bin restrictions specified by the order code.

**STANDARD ORDER CODES AND BINS (ML-E SERIES, COOL WHITE,  $T_j = 25\text{ }^\circ\text{C}$ )**

XLamp ML-E Series, Standard Kit Codes - White					
Chromaticity		Minimum Luminous Flux (lm) @ 50 mA*		Order Codes	
Kit	CCT	Code	Flux (lm)	Typical CRI (75)	80 CRI Minimum
ANSI Cool White (4500 K – 8300 K)					
DT	7000 K	N3	56.8	MLESWT-A1-0000-0005DT	
		N2	51.7	MLESWT-A1-0000-0004DT	
		M3	45.7	MLESWT-A1-0000-0003DT	
E0		N3	56.8	MLESWT-A1-0000-0005E0	
		N2	51.7	MLESWT-A1-0000-0004E0	
		M3	45.7	MLESWT-A1-0000-0003E0	
51	6500 K	N3	56.8	MLESWT-A1-0000-000551	
		N2	51.7	MLESWT-A1-0000-000451	
		M3	45.7	MLESWT-A1-0000-000351	
E1		N3	56.8	MLESWT-A1-0000-0005E1	
		N2	51.7	MLESWT-A1-0000-0004E1	
		M3	45.7	MLESWT-A1-0000-0003E1	
50	6200 K	N3	56.8	MLESWT-A1-0000-000550	
		N2	51.7	MLESWT-A1-0000-000450	
		M3	45.7	MLESWT-A1-0000-000350	
DV	6000 K	N3	56.8	MLESWT-A1-0000-0005DV	
		N2	51.7	MLESWT-A1-0000-0004DV	
		M3	45.7	MLESWT-A1-0000-0003DV	
E2	5750 K	N3	56.8	MLESWT-A1-0000-0005E2	
		N2	51.7	MLESWT-A1-0000-0004E2	
		M3	45.7	MLESWT-A1-0000-0003E2	
DY	5500 K	N3	56.8	MLESWT-A1-0000-0005DY	
		N2	51.7	MLESWT-A1-0000-0004DY	
		M3	45.7	MLESWT-A1-0000-0003DY	
DZ	5000 K	N3	56.8	MLESWT-A1-0000-0005DZ	
		N2	51.7	MLESWT-A1-0000-0004DZ	
		M3	45.7	MLESWT-A1-0000-0003DZ	
A1		N2	51.7	MLESWT-A1-0000-0004A1	
		M3	45.7	MLESWT-A1-0000-0003A1	
		M2	39.8	MLESWT-A1-0000-0002A1	
E3		N3	56.8	MLESWT-A1-0000-0005E3	
		N2	51.7	MLESWT-A1-0000-0004E3	MLESWT-H1-0000-0004E3
		M3	45.7	MLESWT-A1-0000-0003E3	MLESWT-H1-0000-0003E3
		M2	39.8	MLESWT-A1-0000-0002E3	MLESWT-H1-0000-0002E3

**\* Notes:**

- Cree maintains a tolerance of  $\pm 7\%$  on flux and power measurements,  $\pm 0.005$  on chromaticity (CCx, CCy) measurements and  $\pm 2$  on CRI measurements.
- Typical CRI for Cool White order codes is 75; Typical CRI for Warm White order codes is 80.
- Cree XLamp order codes specify only a minimum flux bin and not a maximum. Cree may ship reels in flux bins higher than the minimum specified by the order code without advance notice. Shipments will always adhere to the chromaticity bin restrictions specified by the order code.

XLamp ML-E Series, Standard Kit Codes - White					
Chromaticity		Minimum Luminous Flux (lm) @ 50 mA*		Order Codes	
Kit	CCT	Code	Flux (lm)	Typical CRI (75)	80 CRI Minimum
F4	4750 K	N2	51.7	MLESWT-A1-0000-0004F4	
		M3	45.7	MLESWT-A1-0000-0003F4	
		M2	39.8	MLESWT-A1-0000-0002F4	
A2		N2	51.7	MLESWT-A1-0000-0004A2	
		M3	45.7	MLESWT-A1-0000-0003A2	
		M2	39.8	MLESWT-A1-0000-0002A2	
E4	4500 K	N2	51.7	MLESWT-A1-0000-0004E4	
		M3	45.7	MLESWT-A1-0000-0003E4	
		M2	39.8	MLESWT-A1-0000-0002E4	

### STANDARD ORDER CODES AND BINS (ML-E SERIES, WARM WHITE, T<sub>j</sub> = 25 °C)

XLamp ML-E Series, Standard Kit Codes - White										
Chromaticity		Minimum Luminous Flux (lm) @ 50 mA*		Order Codes						
Kit	CCT	Code	Flux (lm)	Typical CRI (80)	80 CRI Minimum	85 CRI Minimum	90 CRI Minimum			
ANSI Warm White (2600 K – 4300 K)										
A3	4300 K	N2	51.7	MLESWT-A1-0000-0004A3						
		M3	45.7	MLESWT-A1-0000-0003A3						
		M2	39.8	MLESWT-A1-0000-0002A3						
F5	4250 K	N2	51.7	MLESWT-A1-0000-0004F5						
		M3	45.7	MLESWT-A1-0000-0003F5						
		M2	39.8	MLESWT-A1-0000-0002F5						
E5	4000 K	N2	51.7	MLESWT-A1-0000-0004E5						
		M3	45.7	MLESWT-A1-0000-0003E5				MLESWT-H1-0000-0003E5	MLESWT-P1-0000-0003E5	
		M2	39.8	MLESWT-A1-0000-0002E5				MLESWT-H1-0000-0002E5	MLESWT-P1-0000-0002E5	MLESWT-U1-0000-0002E5
		K3	35.2					MLESWT-H1-0000-0001E5	MLESWT-P1-0000-0001E5	MLESWT-U1-0000-0001E5
Z5		N2	51.7	MLESWT-A1-0000-0004Z5						
		M3	45.7	MLESWT-A1-0000-0003Z5				MLESWT-H1-0000-0003Z5	MLESWT-P1-0000-0003Z5	
		M2	39.8	MLESWT-A1-0000-0002Z5				MLESWT-H1-0000-0002Z5	MLESWT-P1-0000-0002Z5	MLESWT-U1-0000-0002Z5
		K3	35.2					MLESWT-H1-0000-0001Z5	MLESWT-P1-0000-0001Z5	MLESWT-U1-0000-0001Z5
A4			N2	51.7	MLESWT-A1-0000-0004A4					
			M3	45.7	MLESWT-A1-0000-0003A4					
			M2	39.8	MLESWT-A1-0000-0002A4					

\* Notes:

- Cree maintains a tolerance of ±7% on flux and power measurements, ±0.005 on chromaticity (CCx, CCy) measurements and ±2 on CRI measurements.
- Typical CRI for Cool White order codes is 75; Typical CRI for Warm White order codes is 80.
- Cree XLamp order codes specify only a minimum flux bin and not a maximum. Cree may ship reels in flux bins higher than the minimum specified by the order code without advance notice. Shipments will always adhere to the chromaticity bin restrictions specified by the order code.

XLamp ML-E Series, Standard Kit Codes - White							
Chromaticity		Minimum Luminous Flux (lm) @ 50 mA*		Order Codes			
Kit	CCT	Code	Flux (lm)	Typical CRI (80)	80 CRI Minimum	85 CRI Minimum	90 CRI Minimum
A5	3750 K	M3	45.7	MLESWT-A1-0000-0003A5			
		M2	39.8	MLESWT-A1-0000-0002A5	MLESWT-H1-0000-0002A5	MLESWT-P1-0000-0002A5	MLESWT-U1-0000-0002A5
		K3	35.2		MLESWT-H1-0000-0001A5	MLESWT-P1-0000-0001A5	MLESWT-U1-0000-0001A5
M3		45.7	MLESWT-A1-0000-0003F6				
F6		M2	39.8	MLESWT-A1-0000-0002F6	MLESWT-H1-0000-0002F6	MLESWT-P1-0000-0002F6	MLESWT-U1-0000-0002F6
		K3	35.2		MLESWT-H1-0000-0001F6	MLESWT-P1-0000-0001F6	MLESWT-U1-0000-0001F6
	M3	45.7	MLESWT-A1-0000-0003E6				
E6	M2	39.8	MLESWT-A1-0000-0002E6	MLESWT-H1-0000-0002E6	MLESWT-P1-0000-0002E6	MLESWT-U1-0000-0002E6	
	K3	35.2		MLESWT-H1-0000-0001E6	MLESWT-P1-0000-0001E6	MLESWT-U1-0000-0001E6	
	M3	45.7	MLESWT-A1-0000-0003Z6				
Z6	M2	39.8	MLESWT-A1-0000-0002Z6	MLESWT-H1-0000-0002Z6	MLESWT-P1-0000-0002Z6	MLESWT-U1-0000-0002Z6	
	K3	35.2		MLESWT-H1-0000-0001Z6	MLESWT-P1-0000-0001Z6	MLESWT-U1-0000-0001Z6	
	M3	45.7	MLESWT-A1-0000-0003A6				
A6	M2	39.8	MLESWT-A1-0000-0002A6	MLESWT-H1-0000-0002A6	MLESWT-P1-0000-0002A6	MLESWT-U1-0000-0002A6	
	K3	35.2		MLESWT-H1-0000-0001A6	MLESWT-P1-0000-0001A6	MLESWT-U1-0000-0001A6	
	M3	45.7	MLESWT-A1-0000-0003A7				
A7	3250 K	M2	39.8	MLESWT-A1-0000-0002A7	MLESWT-H1-0000-0002A7	MLESWT-P1-0000-0002A7	MLESWT-U1-0000-0002A7
		K3	35.2	MLESWT-A1-0000-0001A7	MLESWT-H1-0000-0001A7	MLESWT-P1-0000-0001A7	MLESWT-U1-0000-0001A7
		K2	30.6		MLESWT-H1-0000-0000A7	MLESWT-P1-0000-0000A7	MLESWT-U1-0000-0000A7
M3		45.7	MLESWT-A1-0000-0003F7				
F7		M2	39.8	MLESWT-A1-0000-0002F7	MLESWT-H1-0000-0002F7	MLESWT-P1-0000-0002F7	MLESWT-U1-0000-0002F7
		K3	35.2	MLESWT-A1-0000-0001F7	MLESWT-H1-0000-0001F7	MLESWT-P1-0000-0001F7	MLESWT-U1-0000-0001F7
	K2	30.6		MLESWT-H1-0000-0000F7	MLESWT-P1-0000-0000F7	MLESWT-U1-0000-0000F7	
E7	M3	45.7	MLESWT-A1-0000-0003E7				
	M2	39.8	MLESWT-A1-0000-0002E7	MLESWT-H1-0000-0002E7	MLESWT-P1-0000-0002E7	MLESWT-U1-0000-0002E7	
	K3	35.2	MLESWT-A1-0000-0001E7	MLESWT-H1-0000-0001E7	MLESWT-P1-0000-0001E7	MLESWT-U1-0000-0001E7	
Z7	3000 K	K2	30.6		MLESWT-H1-0000-0000E7	MLESWT-P1-0000-0000E7	MLESWT-U1-0000-0000E7
		M3	45.7	MLESWT-A1-0000-0003Z7			
		M2	39.8	MLESWT-A1-0000-0002Z7	MLESWT-H1-0000-0002Z7	MLESWT-P1-0000-0002Z7	MLESWT-U1-0000-0002Z7
K3		35.2	MLESWT-A1-0000-0001Z7	MLESWT-H1-0000-0001Z7	MLESWT-P1-0000-0001Z7	MLESWT-U1-0000-0001Z7	
A8		K2	30.6		MLESWT-H1-0000-0000Z7	MLESWT-P1-0000-0000Z7	MLESWT-U1-0000-0000Z7
		M3	45.7	MLESWT-A1-0000-0003A8			
	M2	39.8	MLESWT-A1-0000-0002A8	MLESWT-H1-0000-0002A8	MLESWT-P1-0000-0002A8	MLESWT-U1-0000-0002A8	
A8	K3	35.2	MLESWT-A1-0000-0001A8	MLESWT-H1-0000-0001A8	MLESWT-P1-0000-0001A8	MLESWT-U1-0000-0001A8	
	K2	30.6		MLESWT-H1-0000-0000A8	MLESWT-P1-0000-0000A8	MLESWT-U1-0000-0000A8	

\* Notes:

- Cree maintains a tolerance of ±7% on flux and power measurements, ±0.005 on chromaticity (CCx, CCy) measurements and ±2 on CRI measurements.
- Typical CRI for Cool White order codes is 75; Typical CRI for Warm White order codes is 80.
- Cree XLamp order codes specify only a minimum flux bin and not a maximum. Cree may ship reels in flux bins higher than the minimum specified by the order code without advance notice. Shipments will always adhere to the chromaticity bin restrictions specified by the order code.

XLamp ML-E Series, Standard Kit Codes - White							
Chromaticity		Minimum Luminous Flux (lm) @ 50 mA*		Order Codes			
Kit	CCT	Code	Flux (lm)	Typical CRI (80)	80 CRI Minimum	85 CRI Minimum	90 CRI Minimum
A9	2850 K	M2	39.8	MLESWT-A1-0000-0002A9			
		K3	35.2	MLESWT-A1-0000-0001A9	MLESWT-H1-0000-0001A9	MLESWT-P1-0000-0001A9	MLESWT-U1-0000-0001A9
		K2	30.6		MLESWT-H1-0000-0000A9	MLESWT-P1-0000-0000A9	MLESWT-U1-0000-0000A9
F8		M2	39.8	MLESWT-A1-0000-0002F8			
		K3	35.2	MLESWT-A1-0000-0001F8	MLESWT-H1-0000-0001F8	MLESWT-P1-0000-0001F8	MLESWT-U1-0000-0001F8
		K2	30.6		MLESWT-H1-0000-0000F8	MLESWT-P1-0000-0000F8	MLESWT-U1-0000-0000F8
E8	2700 K	M2	39.8	MLESWT-A1-0000-0002E8			
		K3	35.2	MLESWT-A1-0000-0001E8	MLESWT-H1-0000-0001E8	MLESWT-P1-0000-0001E8	MLESWT-U1-0000-0001E8
		K2	30.6		MLESWT-H1-0000-0000E8	MLESWT-P1-0000-0000E8	MLESWT-U1-0000-0000E8
Z8		M2	39.8	MLESWT-A1-0000-0002Z8			
		K3	35.2	MLESWT-A1-0000-0001Z8	MLESWT-H1-0000-0001Z8	MLESWT-P1-0000-0001Z8	MLESWT-U1-0000-0001Z8
		K2	30.6		MLESWT-H1-0000-0000Z8	MLESWT-P1-0000-0000Z8	MLESWT-U1-0000-0000Z8
AA	M2	39.8	MLESWT-A1-0000-0002AA				
	K3	35.2	MLESWT-A1-0000-0001AA	MLESWT-H1-0000-0001AA	MLESWT-P1-0000-0001AA	MLESWT-U1-0000-0001AA	
	K2	30.6		MLESWT-H1-0000-0000AA	MLESWT-P1-0000-0000AA	MLESWT-U1-0000-0000AA	

### STANDARD ORDER CODES AND BINS (ML-E PARALLEL COLOR, T<sub>j</sub> = 25 °C)

XLamp ML-E Parallel, Standard Kit Codes - Royal Blue				
Royal Blue		Minimum Radiant Flux (lm) @ 150 mA*		Order Codes
Kit	Dominant Wavelength (nm)	Code	Flux (mW)	
01	450 - 465	10	175	MLEROY-A1-0000-000501
02	450 - 460	10	175	MLEROY-A1-0000-000502
03	455 - 465	10	175	MLEROY-A1-0000-000503

XLamp ML-E Parallel, Standard Kit Codes - Blue				
Blue		Minimum Luminous Flux (lm) @ 150 mA*		Order Codes
Kit	Dominant Wavelength (nm)	Code	Flux (lm)	
01	465 - 485	G0	13.9	MLEBLU-A1-0000-000U01
		F0	10.7	MLEBLU-A1-0000-000T01
02	465 - 480	G0	13.9	MLEBLU-A1-0000-000U02
		F0	10.7	MLEBLU-A1-0000-000T02
05	470 - 480	G0	13.9	MLEBLU-A1-0000-000U05
		F0	10.7	MLEBLU-A1-0000-000T05

\* Notes:

- Cree maintains a tolerance of ±7% on flux and power measurements, ±0.005 on chromaticity (CCx, CCy) measurements and ±2 on CRI measurements.
- Typical CRI for Cool White order codes is 75; Typical CRI for Warm White order codes is 80.
- Cree XLamp order codes specify only a minimum flux bin and not a maximum. Cree may ship reels in flux bins higher than the minimum specified by the order code without advance notice. Shipments will always adhere to the chromaticity bin restrictions specified by the order code.

XLamp ML-E Parallel, Standard Kit Codes - Green				
Green		Minimum Luminous Flux (lm) @ 150 mA*		Order Codes
Kit	Dominant Wavelength (nm)	Code	Flux (lm)	
01	520 - 535	K3	35.2	MLEGRN-A1-0000-000101
		K2	30.6	MLEGRN-A1-0000-000001
		J3	26.8	MLEGRN-A1-0000-000X01
02	520 - 530	K3	35.2	MLEGRN-A1-0000-000102
		K2	30.6	MLEGRN-A1-0000-000002
		J3	26.8	MLEGRN-A1-0000-000X02
03	525 - 535	K3	35.2	MLEGRN-A1-0000-000103
		K2	30.6	MLEGRN-A1-0000-000003
		J3	26.8	MLEGRN-A1-0000-000X03

XLamp ML-E Parallel, Standard Kit Codes - Amber				
Amber		Minimum Luminous Flux (lm) @ 150 mA*		Order Codes
Kit	Dominant Wavelength (nm)	Code	Flux (lm)	
01	585 - 595	J3	26.8	MLEAMB-A1-0000-000X01
		J2	23.5	MLEAMB-A1-0000-000W01

XLamp ML-E Parallel, Standard Kit Codes - Red				
Red		Minimum Luminous Flux (lm) @ 150 mA*		Order Codes
Kit	Dominant Wavelength (nm)	Code	Flux (lm)	
01	620 - 630	J2	23.5	MLERED-A1-0000-000W01
		H0	18.1	MLERED-A1-0000-000V01
02	620 - 625	J2	23.5	MLERED-A1-0000-000W02
		H0	18.1	MLERED-A1-0000-000V02
03	625 - 630	H0	18.1	MLERED-A1-0000-000V03

\* Notes:

- Cree maintains a tolerance of  $\pm 7\%$  on flux and power measurements,  $\pm 0.005$  on chromaticity (CCx, CCy) measurements and  $\pm 2$  on CRI measurements.
- Typical CRI for Cool White order codes is 75; Typical CRI for Warm White order codes is 80.
- Cree XLamp order codes specify only a minimum flux bin and not a maximum. Cree may ship reels in flux bins higher than the minimum specified by the order code without advance notice. Shipments will always adhere to the chromaticity bin restrictions specified by the order code.



**STANDARD ORDER CODES AND BINS (ML-E SERIES COLOR, T<sub>j</sub> = 25 °C)**

XLamp ML-E Series, Standard Kit Codes - Blue				
Blue		Minimum Luminous Flux (lm) @ 50 mA*		Order Codes
Kit	Dominant Wavelength (nm)	Code	Flux (lm)	
01	465 - 485	G0	13.9	MLESBL-A1-0000-000U01
		F0	10.7	MLESBL-A1-0000-000T01
02	465 - 480	G0	13.9	MLESBL-A1-0000-000U02
		F0	10.7	MLESBL-A1-0000-000T02
05	470 - 480	G0	13.9	MLESBL-A1-0000-000U05
		F0	10.7	MLESBL-A1-0000-000T05

XLamp ML-E Series, Standard Kit Codes - Green				
Green		Minimum Luminous Flux (lm) @ 50 mA*		Order Codes
Kit	Dominant Wavelength (nm)	Code	Flux (lm)	
01	520 - 535	K3	35.2	MLESGN-A1-0000-000101
		K2	30.6	MLESGN-A1-0000-000001
		J3	26.8	MLESGN-A1-0000-000X01
02	520 - 530	K3	35.2	MLESGN-A1-0000-000102
		K2	30.6	MLESGN-A1-0000-000002
		J3	26.8	MLESGN-A1-0000-000X02
03	525 - 535	K3	35.2	MLESGN-A1-0000-000103
		K2	30.6	MLESGN-A1-0000-000003
		J3	26.8	MLESGN-A1-0000-000X03

XLamp ML-E Series, Standard Kit Codes - Amber				
Amber		Minimum Luminous Flux (lm) @ 37.5 mA*		Order Codes
Kit	Dominant Wavelength (nm)	Code	Flux (lm)	
01	585 - 595	J3	26.8	MLESAM-A1-0000-000X01
		J2	23.5	MLESAM-A1-0000-000W01

XLamp ML-E Series, Standard Kit Codes - Red				
Red		Minimum Luminous Flux (lm) @ 37.5 mA*		Order Codes
Kit	Dominant Wavelength (nm)	Code	Flux (lm)	
01	620 - 630	J2	23.5	MLESRD-A1-0000-000W01
		H0	18.1	MLESRD-A1-0000-000V01
02	620 - 625	J2	23.5	MLESRD-A1-0000-000W02
		H0	18.1	MLESRD-A1-0000-000V02

**\* Notes:**

- Cree maintains a tolerance of ±7% on flux and power measurements, ±0.005 on chromaticity (CCx, CCy) measurements and ±2 on CRI measurements.
- Typical CRI for Cool White order codes is 75; Typical CRI for Warm White order codes is 80.
- Cree XLamp order codes specify only a minimum flux bin and not a maximum. Cree may ship reels in flux bins higher than the minimum specified by the order code without advance notice. Shipments will always adhere to the chromaticity bin restrictions specified by the order code.