

3 Handling WINSTA® MIDI, 770 Series

58

Preparation

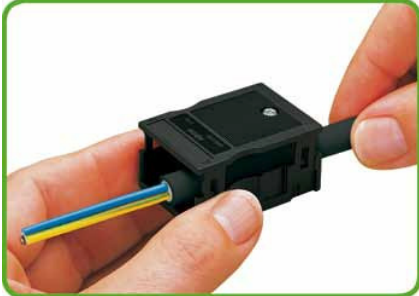

We recommend pulling the pre-latched strain relief housing over the cable prior to termination. However, the strain relief can be mounted at a later time as well.

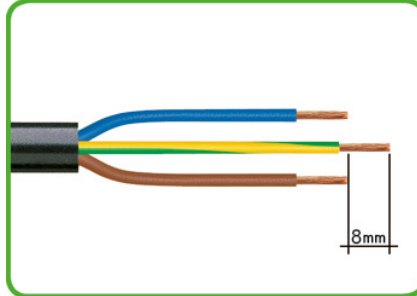

1. Strip length, outer insulation = x mm ①
2. Strip length = 9 mm
3. Extended ground conductor = 8 mm

Conductor termination with CAGE CLAMP® S

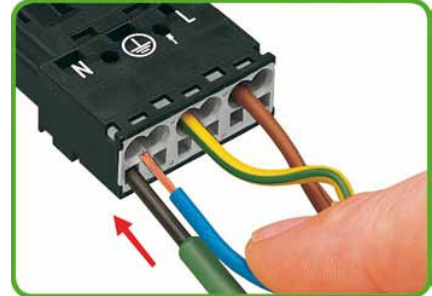

To terminate fine-stranded conductors, open clamping unit via 2.5mm screwdriver and insert stripped conductor until it hits backstop.

Conductor termination with CAGE CLAMP® S

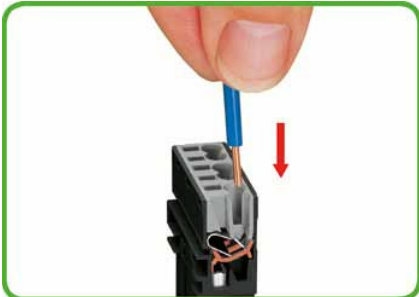

Insert stripped solid conductor until it hits backstop.



To terminate fine-stranded conductors, open clamping unit via 2.5mm screwdriver and insert stripped conductor until it hits backstop.

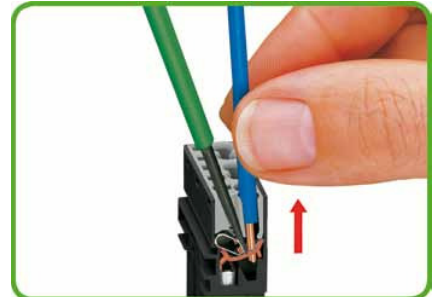

To remove the conductor, actuate the clamp via 2.5mm screwdriver and pull out the conductor.

Strain relief installation



Latch the strain relief housing on the plug/socket. Note the "TOP" inscription.



Prepare strain relief housing by snapping together upper and bottom part.



Tighten strain relief screw using a 2.5 mm screwdriver.

Variable coding



Simply break or cut off the coding pin from the socket.



Insert coding pin into plug (break first) until it engages.

Marking





Marking strain relief housing via WSB quick marking system.

① Strip length, outer insulation: 2-pole = 35mm, 3- to 5-pole = 55mm





3 WINSTA® MIDI

78

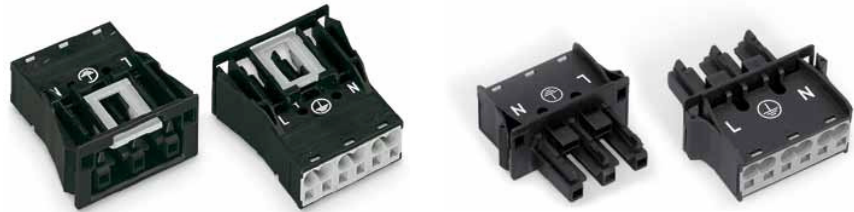
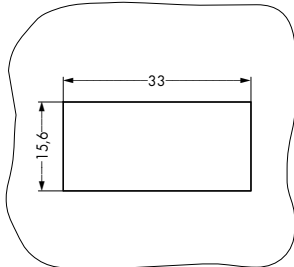
Snap-In Sockets, 3-Pole

Cutout dimensions Plate thickness: 0.5 – 2 mm Cutout tolerance: + 0.1 mm	2 x 0.5 – 4 mm ² ① 250 V/4 kV/3 I _N 25 A	2 x AWG 20 – 12	2 x 0.5 – 4 mm ² ① 250 V/4 kV/3 I _N 25 A	2 x AWG 20 – 12
	 9 mm / 0.35 in ② Approvals		 9 mm / 0.35 in ② Approvals	



Description	Color	Item No.	Pack. Unit	Color	Item No.	Pack. Unit
Pluggable connectors, snap-in device connection, 3-pole, with CAGE CLAMP® S connection, snap-in frame, 3-pole	Socket			Socket with protruding interface		
	● black	770-703	100	● black	770-703/009-000	45
	○ white	770-723	100	○ white	770-723/009-000	45
	● red	770-2303	100			
	● orange	770-2343	100			
	● brown	770-2363	100			
Item-Specific Accessories						
	Lockout cap, for socket, separable, 12-pole			Lockout cap, for socket, separable, 12-pole		
		black 770-201	100		black 770-201	100
		white 770-221	100		white 770-221	100
Accessories, 770 Series						
	Lockout cap, for cutout, 3-pole			Lockout cap, for cutout, 3-pole		
		black 770-643	100		black 770-643	100
		white 770-693	100		white 770-693	100
Info	Dimensions					

① Conductor sizes: 0.5 – 4 mm² "s + f-st"
 0.5 – 2.5 mm² "stranded"

② For "International Certification Organizations" and "Approvals – User Guide," see pages 240 to 243.

● black Coding A (L ⊕ N)
 ○ white Coding A (L ⊕ N)
 ● red Coding P (L ⊕ N)
 ● orange Coding R (LON LON S)
 ● brown Coding S (1 2 L)

For coding information, see pages 224 to 226.
 Fire load data available upon request.

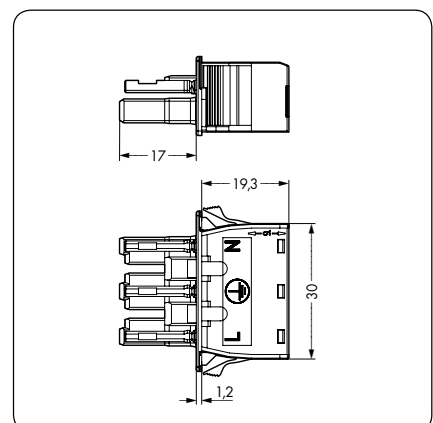
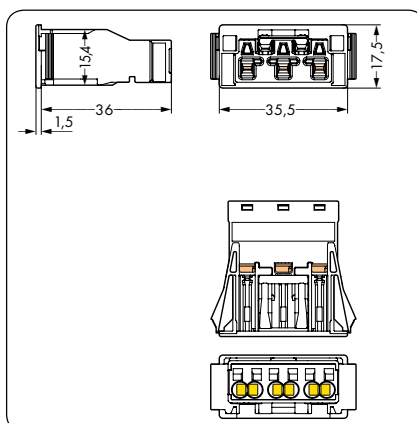

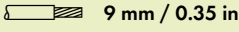
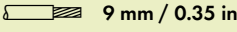

Snap-In Plugs and Frames, 3-pole

<p>2 x 0.5 – 4 mm² ① 250 V/4 kV/3 I_N 25 A</p> <p> 9 mm / 0.35 in</p> <p>② Approvals</p>	<p>2 x AWG 20 – 12</p>	<p>2 x 0.5 – 4 mm² ① 250 V/4 kV/3 I_N 25 A</p> <p> 9 mm / 0.35 in</p> <p>② Approvals</p>	<p>2 x AWG 20 – 12</p>	<p>Snap-in frames: – for 3-pole sockets and plugs (see page 75) Plate thickness: 1 – 3 mm</p>
--	------------------------	--	------------------------	---



Color	Item No.	Pack. Unit	Color	Item No.	Pack. Unit	Color	Item No.	Pack. Unit
Plug			Plug with direct ground contact			Snap-in frame, 3-pole		
● black	770-713	100	● black	770-713/007-000	100	black	770-318	100
○ white	770-733	100	○ white	770-733/007-000	100	white	770-338	100
● red	770-2313	100	● red	770-2313/007-000	100			
● orange	770-2353	100						

Item-Specific Accessories		
Lockout cap, for plug, separable, 5-pole		
	yellow	770-360 100
Coding pin, for plug (A and B coding)		
	gray	770-401 100
Accessories, 770 Series		
Lockout cap, for cutout, 3-pole		
	black	770-643 100
	white	770-693 100



Insert the socket or plug into the frame (observe the "TOP" marking on the frame!). Snap the assembled unit into the cutout.

Dimensions

