

connectors

Red range

Industrial rack and panel connectors

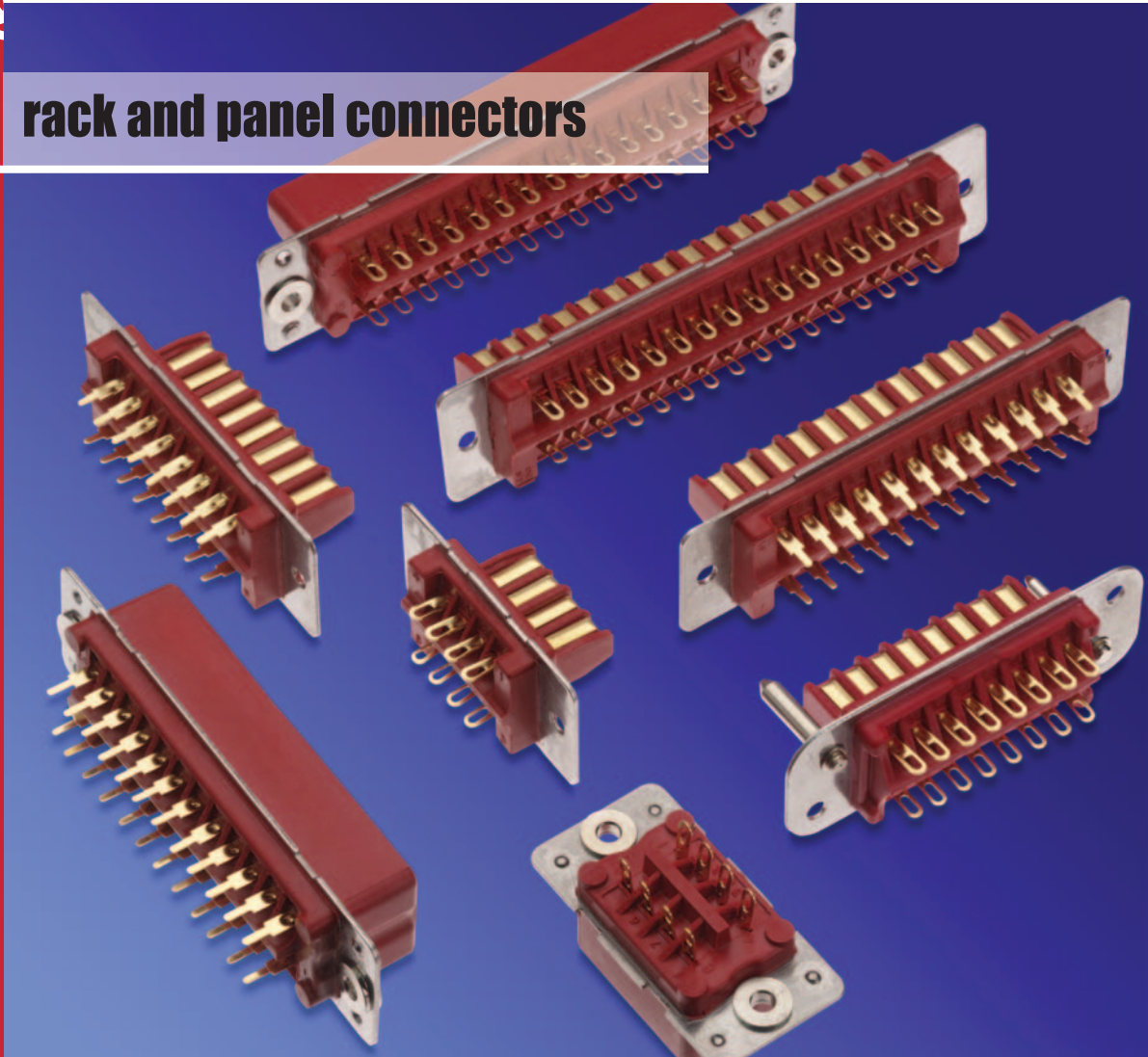

TW **McMurdo**
Connector

Industrial rack and panel connectors

This comprehensive range of rugged rack and panel connectors is available in four sizes with options for both pcb or cable mounting. These connectors are used throughout industry in blind mating applications.

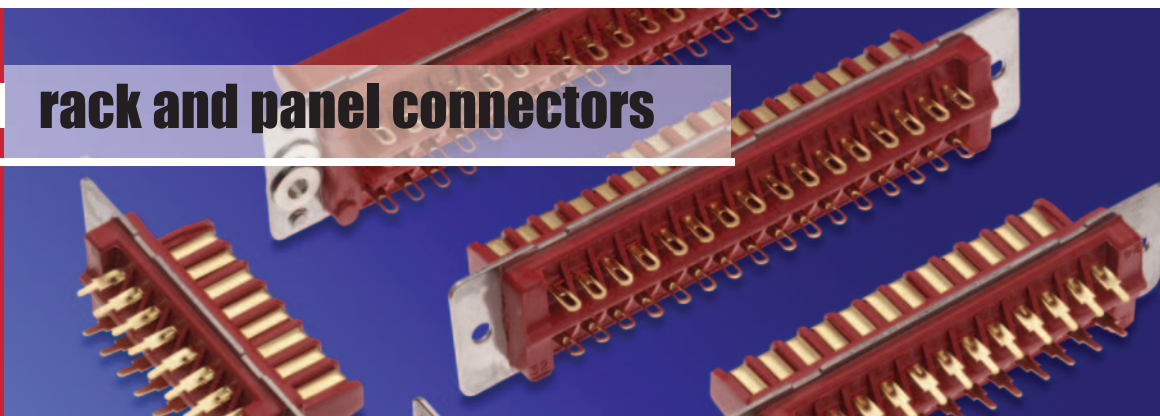

FEATURES

Rugged construction

180° polarised

Dowel polarised for blind mating

Floating bushes to assist alignment

Excellent current carrying characteristics

Pcb or cable mounted

Available in four sizes

Cover with universal top or side entry cable clamp

Technical Data

MATERIALS

Insulator

Nylon PF or Diallyl-phthalate (DAP)

Contact

Copper alloy plated hard acid gold

Mounting plates

Stainless steel

Latching screws & bushes

Mild steel bright nickel plate

Dowels

Brass nickel plate

Covers

Aluminium alloy

MECHANICAL

Mechanical operations

Nylon PF

DAP

Insertion and withdrawal force (per contact pair)

500

500

2.3N max
/0.8 min

2.3N max
/0.8 min

ELECTRICAL

Current

All contacts (simultaneously)

Nylon PF

DAP

at 80°C Tamb.
5A max

at 100°C Tamb.
5A max

Working voltage

800V d.c.
or a.c.peak

800V d.c.
or a.c.peak

Proof voltage

3.5k V d.c.
or a.c.peak

3.5k V d.c.
or a.c.peak

Contact resistance - (initially)
- (after conditioning)

5mΩ max
10mΩ max

5mΩ max
10mΩ max

Insulation resistance – (initially)
- (after conditioning)

10⁹MΩ min
10⁴MΩ min

10⁹MΩ min
10⁴MΩ min

ENVIRONMENTAL

Climatic category

40/100/21

55/125/56

Barrier Polarised

Plug and socket dimensions

No. of Ways	A max	B crs	C max
8	43.94	34.92	26.42
16	62.99	53.97	45.47
24	82.04	73.02	64.52
32	101.09	92.07	83.57

Plug

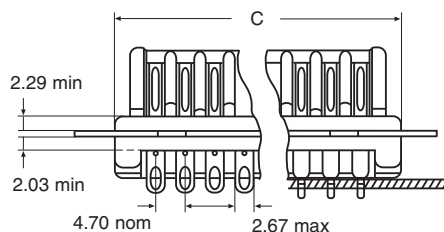
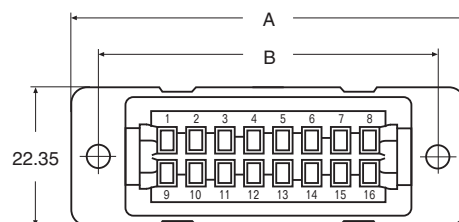

Socket

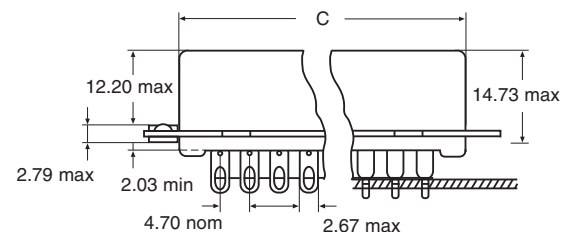
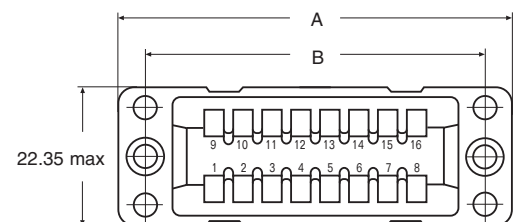

Barrier Polarised

Plug

Solder termination PC termination

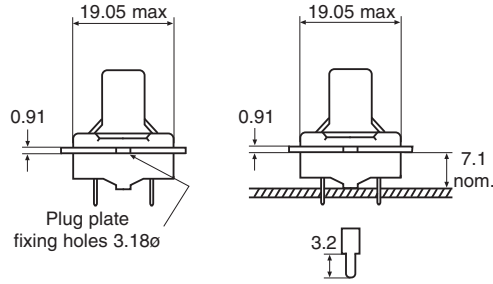

Socket

Solder termination PC termination

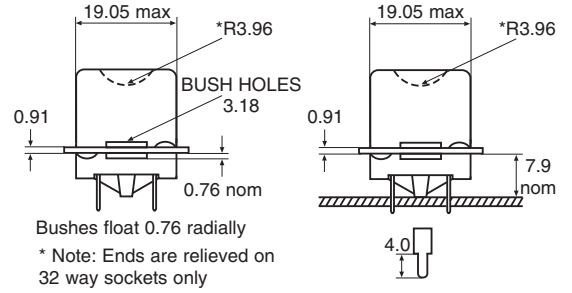

Mounting details

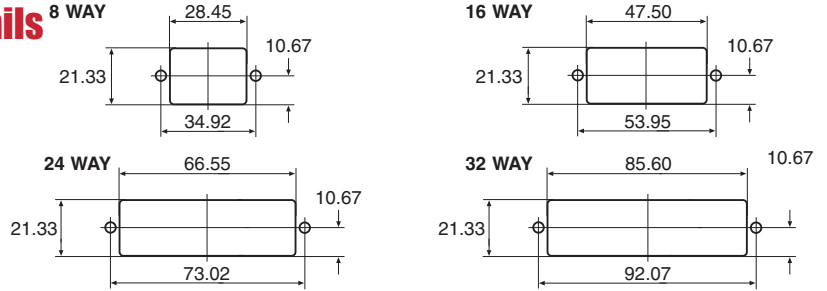

P.C.B. layout

View from rear of plug

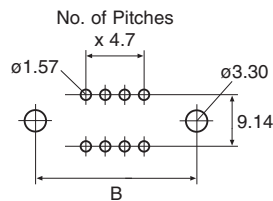

View from rear of sockets

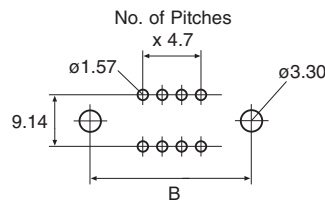

Barrier polarised plug and socket mated

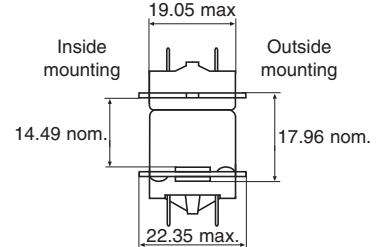

Dowel Polarised

Plug

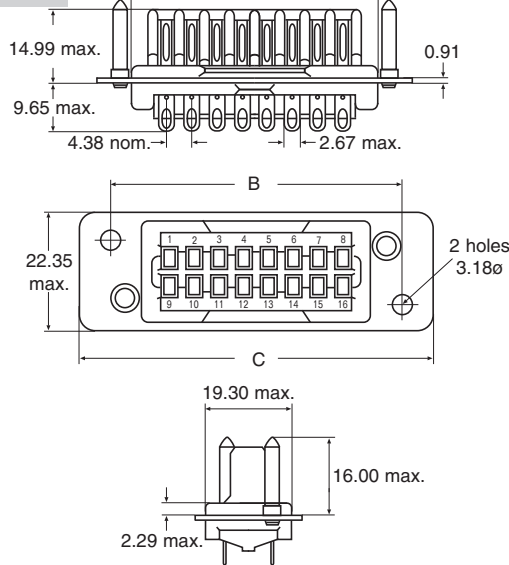

Socket

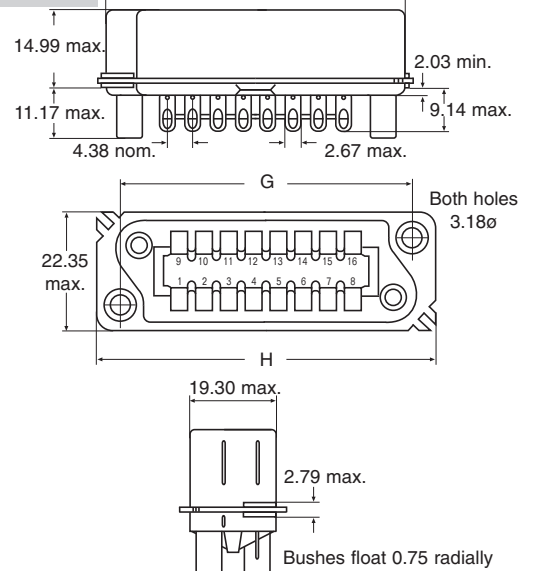

Dimensions

No. of Ways	A max	B crs	C max	D crs	E nom	F max	G crs	H max	I crs	J nom
16 way	39.65	51.41	62.15	46.79	40.64	57.90	51.61	61.98	46.81	44.70
24 way	57.02	68.68	79.45	64.06	57.91	74.17	68.48	79.32	63.58	61.72
32 way	74.50	85.95	96.77	81.33	75.54	91.95	85.95	96.65	81.33	79.48

Mounting details from wiring side

Plug

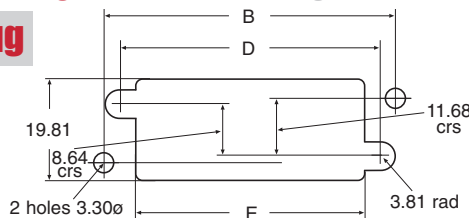

Socket

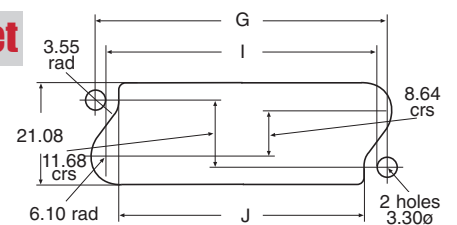

ORDERING information

DESCRIPTION			ORDER CODE	
Style	Gender	No. of Ways	Moulding Material	
			Nylon PF	Diallyl-Phthalate
Barrier Polarised	Plug	8	RP8	DRP108
		16	RP16	DRP116
		24	RP24	DRP124
		32	RP32	DRP132
	Socket	8	RS8*	DRS108*
		16	RS16*	DRS116*
		24	RS24*	DRS124*
		32	RS32*	DRS132*
Barrier Polarised P.C.B Tail	Plug	8	RP8-T	DRP108-T
		16	RP16-T	DRP116-T
		24	RP24-T	DRP124-T
		32	RP32-T	DRP132-T
	Socket	8	RS8P-T	DRS108P-T
		16	RS16P-T	DRS116P-T
		24	RS24P-T	DRS124P-T
		32	RS32P-T	DRS132P-T
Dowel Polarised	Plug	16	RPD16	DRPD116
		24	-	DRPD124
		32	-	DRPD132
	Socket	16	RSD16	DRSD116
		24	-	DRSD124
		32	-	DRSD132

*Sockets are normally supplied with floating bushes to assist alignment when mounted on racks and chassis. For sockets without floating bushes – add **P** to end of order code e.g. Order code RS24P.

ACCESSORIES

ACCESSORY ORDERING INFORMATION

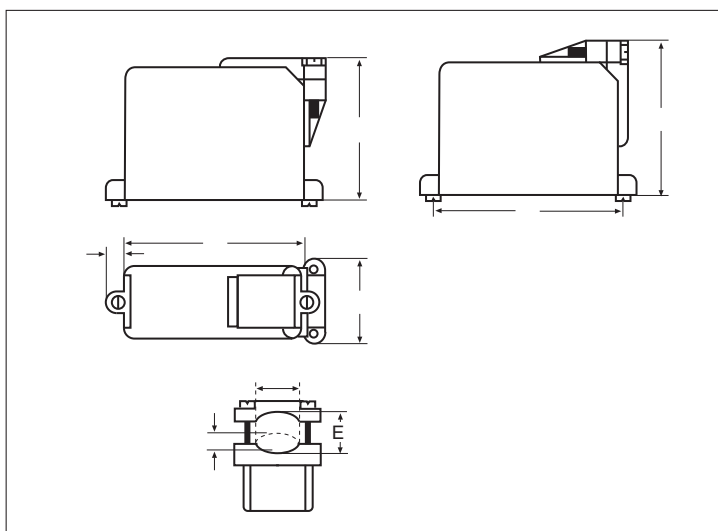

Contact Arrangement	A max	B crs	C max	D max	E max
8	32.51	34.92	36.83	40.89	9.40
16	51.56	53.97	43.18	47.24	12.70
24	70.61	73.02	43.18	47.24	15.74
32	89.66	92.07	43.18	47.24	15.74

Description	Order Code	Description	Order Code
8 way cover	RC108	24 way cover	RC124
16 way cover	RC116	32 way cover	RC132
Latch clip	RL-H	Latch plate	RL-L

COVER with LATCHING CLIPS

Latching clips are supplied separately, 2 off each per assembly. When the latching clips are fitted to sockets it is advisable to use sockets without the floating bushes – add **P** to end of order code. For full details of all our accessories please contact our sales department.



A comprehensive range

In addition to rack and panel connectors we supply a comprehensive range of connectors for a variety of applications including general industrial, I.T. and military.

Due to our policy of continuous product development, ITW McMurdo Connectors retain the right to change the specification at any time without prior notice. Designed and printed in the UK.

ITW McMurdo Connectors
Division of ITW Limited
Norway Road
Hilsea
Portsmouth
PO3 5HT
United Kingdom
Tel: 02392 656200
Fax: 02392 666352
e-mail: info@itwmcmurdo.co.uk
www.itwmcmurdo.co.uk

ITW **McMurdo**
Connector