

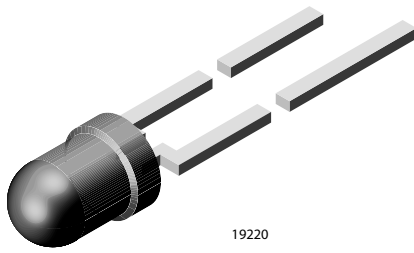

High Efficiency LED in Ø 3 mm Tinted Diffused Package



DESCRIPTION

The TLH.44.. series was developed for standard applications like general indicating and lighting purposes.

It is housed in a 3 mm tinted diffused plastic package. The wide viewing angle of these devices provides a high on-off contrast.

Several selection types with different luminous intensities are offered. All LEDs are categorized in luminous intensity groups. The green and yellow LEDs are categorized additionally in wavelength groups.

That allows users to assemble LEDs with uniform appearance.

FEATURES

- Standard Ø 3 mm (T-1) package
Small mechanical tolerances
Suitable for DC and high peak current
Wide viewing angle
Luminous intensity categorized
Yellow and green color categorized
Material categorization: for definitions of compliance please see www.vishay.com/doc?99912



APPLICATIONS

- Status lights
Off / on indicator
Background illumination
Readout lights
Maintenance lights
Legend light

PRODUCT GROUP AND PACKAGE DATA

- Product group: LED
Package: 3 mm
Product series: standard
Angle of half intensity: ± 30°

Table with 14 columns: PART, COLOR, LUMINOUS INTENSITY (mcd) [MIN., TYP., MAX.], at If (mA), WAVELENGTH (nm) [MIN., TYP., MAX.], at If (mA), FORWARD VOLTAGE (V) [MIN., TYP., MAX.], at If (mA), TECHNOLOGY. Rows include TLHR4400 (Red), TLHO4400 (Soft orange), and TLHY4400 (Yellow).



PARTS TABLE														
PART	COLOR	LUMINOUS INTENSITY (mcd)			at I _F (mA)	WAVELENGTH (nm)			at I _F (mA)	FORWARD VOLTAGE (V)			at I _F (mA)	TECHNOLOGY
		MIN.	TYP.	MAX.		MIN.	TYP.	MAX.		MIN.	TYP.	MAX.		
TLHY4401	Yellow	2.5	10.5	-	10	581	-	594	10	-	2.4	3	20	GaAsP on GaP
TLHY4401-AS12Z	Yellow	2.5	10.5	-	10	581	-	594	10	-	2.4	3	20	GaAsP on GaP
TLHY4405	Yellow	6.3	11	-	10	581	-	594	10	-	2.4	3	20	GaAsP on GaP
TLHY4405-AS12	Yellow	6.3	11	-	10	581	-	594	10	-	2.4	3	20	GaAsP on GaP
TLHY4405-BT12Z	Yellow	6.3	11	-	10	581	-	594	10	-	2.4	3	20	GaAsP on GaP
TLHY4405-MS12	Yellow	6.3	11	-	10	581	-	594	10	-	2.4	3	20	GaAsP on GaP
TLHY4438	Yellow	6.3	-	20	10	583	-	590	10	-	2.4	3	20	GaAsP on GaP
TLHG4400	Green	2.5	13	-	10	562	-	575	10	-	2.4	3	20	GaP on GaP
TLHG4400-MS12	Green	2.5	13	-	10	562	-	575	10	-	2.4	3	20	GaP on GaP
TLHG4401	Green	4	14	-	10	562	-	575	10	-	2.4	3	20	GaP on GaP
TLHG4405	Green	6.3	15	-	10	562	-	575	10	-	2.4	3	20	GaP on GaP

ABSOLUTE MAXIMUM RATINGS (T _{amb} = 25 °C, unless otherwise specified) TLHR440., TLHO440., TLHY440., TLHG440., TLHP440.				
PARAMETER	TEST CONDITION	SYMBOL	VALUE	UNIT
Reverse voltage		V _R	6	V
DC forward current		I _F	30	mA
Surge forward current	t _p ≤ 10 μs	I _{FSM}	1	A
Power dissipation	T _{amb} ≤ 60 °C	P _V	100	mW
Junction temperature		T _j	100	°C
Operating temperature range		T _{amb}	-40 to +100	°C
Storage temperature range		T _{stg}	-55 to +100	°C
Soldering temperature	t ≤ 5 s, 2 mm from body	T _{sd}	260	°C
Thermal resistance junction/ambient		R _{thJA}	400	K/W

OPTICAL AND ELECTRICAL CHARACTERISTICS (T _{amb} = 25 °C, unless otherwise specified) TLHR440., RED							
PARAMETER	TEST CONDITION	PART	SYMBOL	MIN.	TYP.	MAX.	UNIT
Luminous intensity ⁽¹⁾	I _F = 10 mA	TLHR4400	I _V	1.6	13	-	mcd
		TLHR4401	I _V	2.5	14	-	mcd
		TLHR4405	I _V	6.3	15	-	mcd
		TLHR4407	I _V	4	-	12.5	mcd
Dominant wavelength	I _F = 10 mA		λ _d	612	-	625	nm
Peak wavelength	I _F = 10 mA		λ _p	-	635	-	nm
Angle of half intensity	I _F = 10 mA		φ	-	± 30	-	deg
Forward voltage	I _F = 20 mA		V _F	-	2	3	V
Reverse voltage	I _R = 10 μA		V _R	6	15	-	V
Junction capacitance	V _R = 0 V, f = 1 MHz		C _j	-	50	-	pF

Note

⁽¹⁾ In one packing unit I_{Vmin}/I_{Vmax} ≤ 0.5

**OPTICAL AND ELECTRICAL CHARACTERISTICS** ($T_{amb} = 25\text{ }^{\circ}\text{C}$, unless otherwise specified)
TLHO440., SOFT ORANGE

PARAMETER	TEST CONDITION	PART	SYMBOL	MIN.	TYP.	MAX.	UNIT
Luminous intensity ⁽¹⁾	$I_F = 10\text{ mA}$	TLHO4400	I_V	1.6	13	-	mcd
Dominant wavelength	$I_F = 10\text{ mA}$		λ_d	598	-	611	nm
Peak wavelength	$I_F = 10\text{ mA}$		λ_p	-	605	-	nm
Angle of half intensity	$I_F = 10\text{ mA}$		ϕ	-	± 30	-	deg
Forward voltage	$I_F = 20\text{ mA}$		V_F	-	2.4	3	V
Reverse voltage	$I_R = 10\text{ }\mu\text{A}$		V_R	6	15	-	V
Junction capacitance	$V_R = 0\text{ V}$, $f = 1\text{ MHz}$		C_j	-	15	-	pF

Note⁽²⁾ In one packing unit $I_{Vmin.}/I_{Vmax.} \leq 0.5$ **OPTICAL AND ELECTRICAL CHARACTERISTICS** ($T_{amb} = 25\text{ }^{\circ}\text{C}$, unless otherwise specified)
TLHY440., YELLOW

PARAMETER	TEST CONDITION	PART	SYMBOL	MIN.	TYP.	MAX.	UNIT
Luminous intensity ⁽¹⁾	$I_F = 10\text{ mA}$	TLHY4400	I_V	1.6	10	-	mcd
		TLHY4401	I_V	2.5	10.5	-	mcd
		TLHY4405	I_V	6.3	11	-	mcd
		TLHY4438	I_V	6.3	-	20	mcd
Dominant wavelength	$I_F = 10\text{ mA}$	TLHY4400	λ_d	581	-	594	nm
		TLHY4401	λ_d	581	-	594	nm
		TLHY4405	λ_d	581	-	594	nm
		TLHY4438	λ_d	583	-	590	nm
Peak wavelength	$I_F = 10\text{ mA}$		λ_p	-	585	-	nm
Angle of half intensity	$I_F = 10\text{ mA}$		ϕ	-	± 30	-	deg
Forward voltage	$I_F = 20\text{ mA}$		V_F	-	2.4	3	V
Reverse voltage	$I_R = 10\text{ }\mu\text{A}$		V_R	6	15	-	V
Junction capacitance	$V_R = 0\text{ V}$, $f = 1\text{ MHz}$		C_j	-	50	-	pF

Note⁽¹⁾ In one packing unit $I_{Vmin.}/I_{Vmax.} \leq 0.5$ **OPTICAL AND ELECTRICAL CHARACTERISTICS** ($T_{amb} = 25\text{ }^{\circ}\text{C}$, unless otherwise specified)
TLHG440., GREEN

PARAMETER	TEST CONDITION	PART	SYMBOL	MIN.	TYP.	MAX.	UNIT
Luminous intensity ⁽¹⁾	$I_F = 10\text{ mA}$	TLHG4400	I_V	2.5	13	-	mcd
		TLHG4401	I_V	4	14	-	mcd
		TLHG4405	I_V	6.3	15	-	mcd
Dominant wavelength	$I_F = 10\text{ mA}$		λ_d	562	-	575	nm
Peak wavelength	$I_F = 10\text{ mA}$		λ_p	-	565	-	nm
Angle of half intensity	$I_F = 10\text{ mA}$		ϕ	-	± 30	-	deg
Forward voltage	$I_F = 20\text{ mA}$		V_F	-	2.4	3	V
Reverse voltage	$I_R = 10\text{ }\mu\text{A}$		V_R	6	15	-	V
Junction capacitance	$V_R = 0\text{ V}$, $f = 1\text{ MHz}$		C_j	-	50	-	pF

Note⁽¹⁾ In one packing unit $I_{Vmin.}/I_{Vmax.} \leq 0.5$



LUMINOUS INTENSITY CLASSIFICATION		
GROUP	LIGHT INTENSITY (mcd)	
STANDARD	MIN.	MAX.
L	1	2
M	1.6	3.2
N	2.5	5
P	4	8
Q	6.3	12.5
R	10	20
S	16	32
T	25	50
U	40	80

Note

- Luminous intensity is tested at a current pulse duration of 25 ms. The above type numbers represent the order groups which include only a few brightness groups. Only one group will be shipped on each bag (there will be no mixing of two groups on each bag).
In order to ensure availability, single brightness groups will not be orderable.
In a similar manner for colors where wavelength groups are measured and binned, single wavelength groups will be shipped on any one bag.
In order to ensure availability, single wavelength groups will not be orderable.

COLOR CLASSIFICATION				
GROUP	DOM. WAVELENGTH (nm)			
	YELLOW		GREEN	
	MIN.	MAX.	MIN.	MAX.
0	-	-	-	-
1	581	584	-	-
2	583	586	-	-
3	585	588	562	565
4	587	590	564	567
5	589	592	566	569
6	591	594	568	571
7	-	-	570	573
8	-	-	572	575

Note

- Wavelengths are tested at a current pulse duration of 25 ms.

TYPICAL CHARACTERISTICS ($T_{amb} = 25\text{ }^{\circ}\text{C}$, unless otherwise specified)

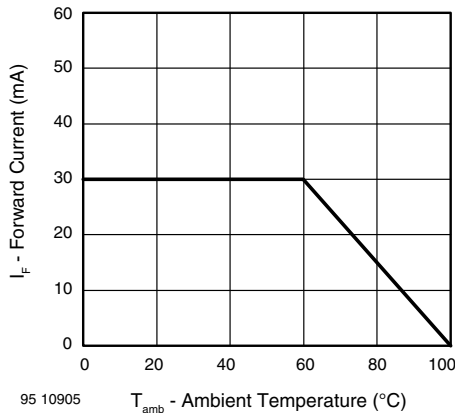

Fig. 1 - Forward Current vs. Ambient Temperature for InGaN



Fig. 2 - Forward Current vs. Pulse Length

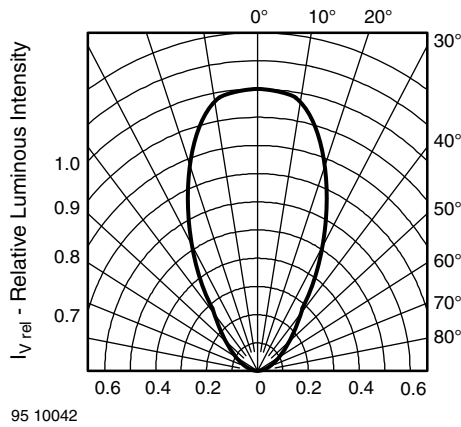

Fig. 3 - Relative Luminous Intensity vs. Angular Displacement

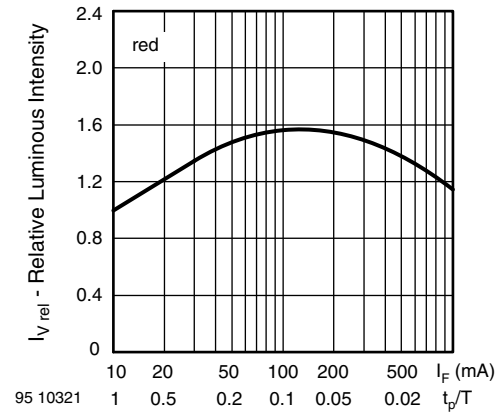

Fig. 6 - Relative Luminous Intensity vs. Forward Current/Duty Cycle



Fig. 4 - Forward Current vs. Forward Voltage

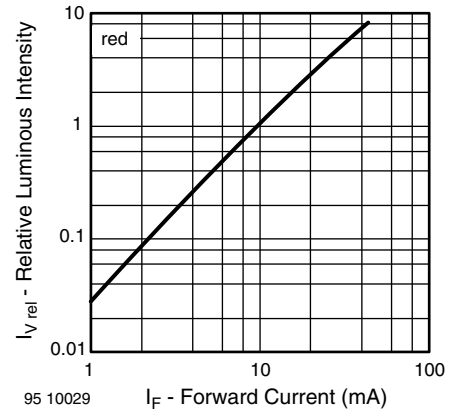

Fig. 7 - Relative Luminous Intensity vs. Forward Current

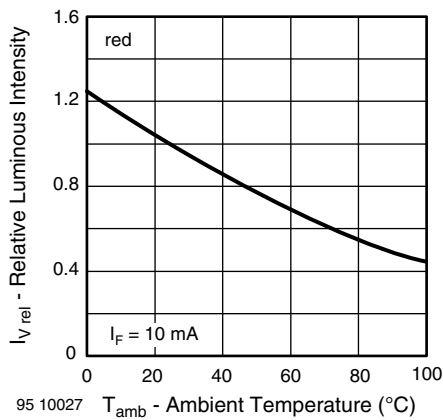

Fig. 5 - Relative Luminous Intensity vs. Ambient Temperature

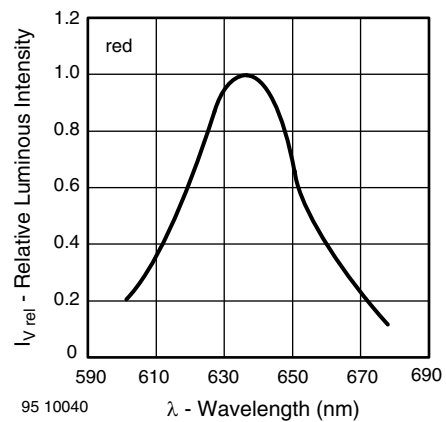

Fig. 8 - Relative Intensity vs. Wavelength

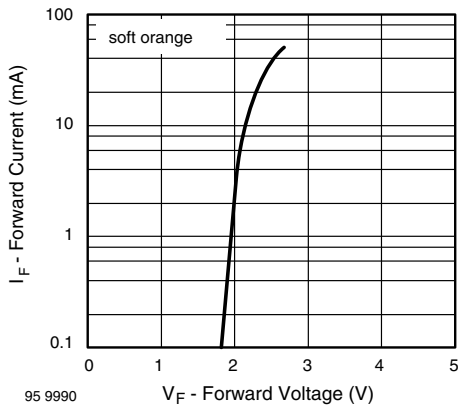

Fig. 9 - Forward Current vs. Forward Voltage

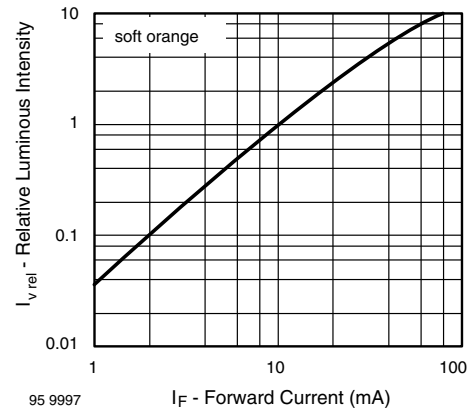

Fig. 12 - Relative Luminous Intensity vs. Forward Current

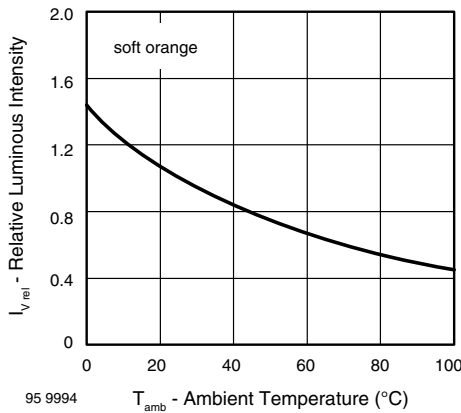

Fig. 10 - Relative Luminous Intensity vs. Ambient Temperature

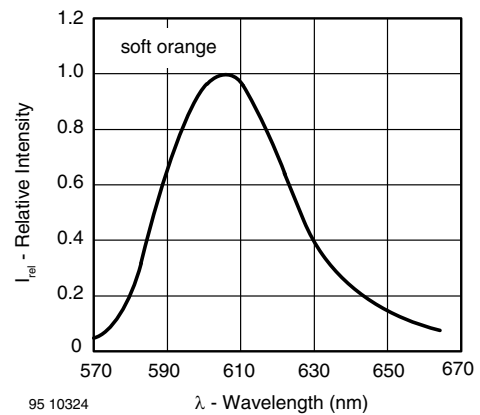

Fig. 13 - Relative Intensity vs. Wavelength



Fig. 11 - Relative Luminous Intensity vs. Forward Current/Duty Cycle



Fig. 14 - Forward Current vs. Forward Voltage

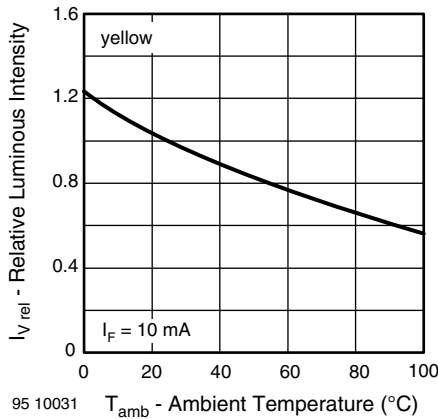

Fig. 15 - Relative Luminous Intensity vs. Ambient Temperature



Fig. 18 - Relative Intensity vs. Wavelength



Fig. 16 - Relative Luminous Intensity vs. Forward Current/Duty Cycle

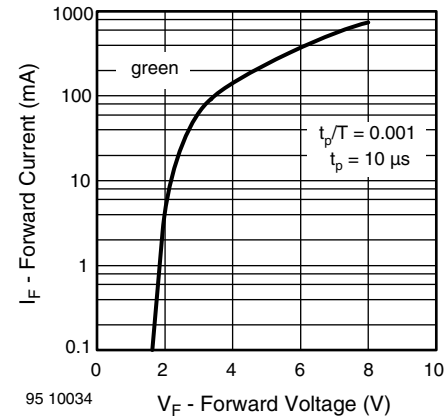

Fig. 19 - Forward Current vs. Forward Voltage

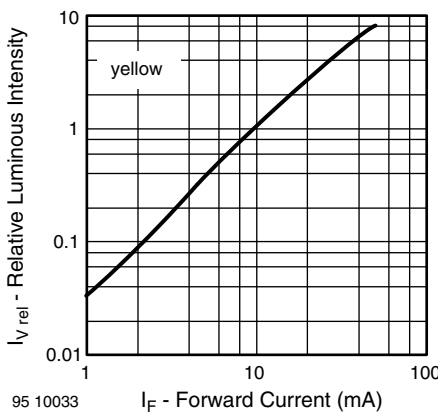

Fig. 17 - Relative Luminous Intensity vs. Forward Current



Fig. 20 - Relative Luminous Intensity vs. Ambient Temperature

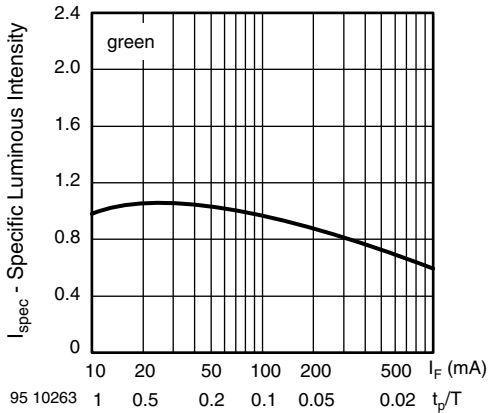

Fig. 21 - Specific Luminous Intensity vs. Forward Current

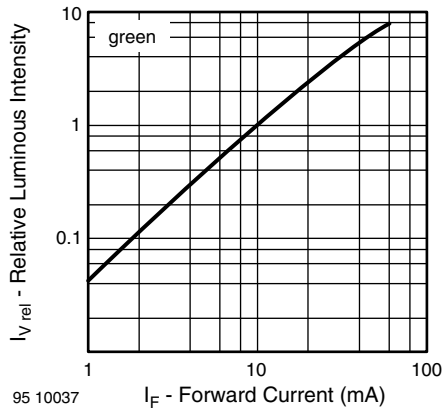

Fig. 22 - Relative Luminous Intensity vs. Forward Current

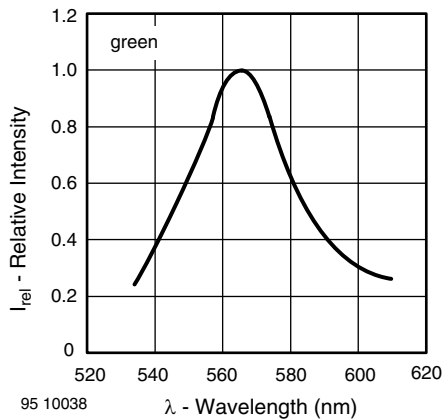
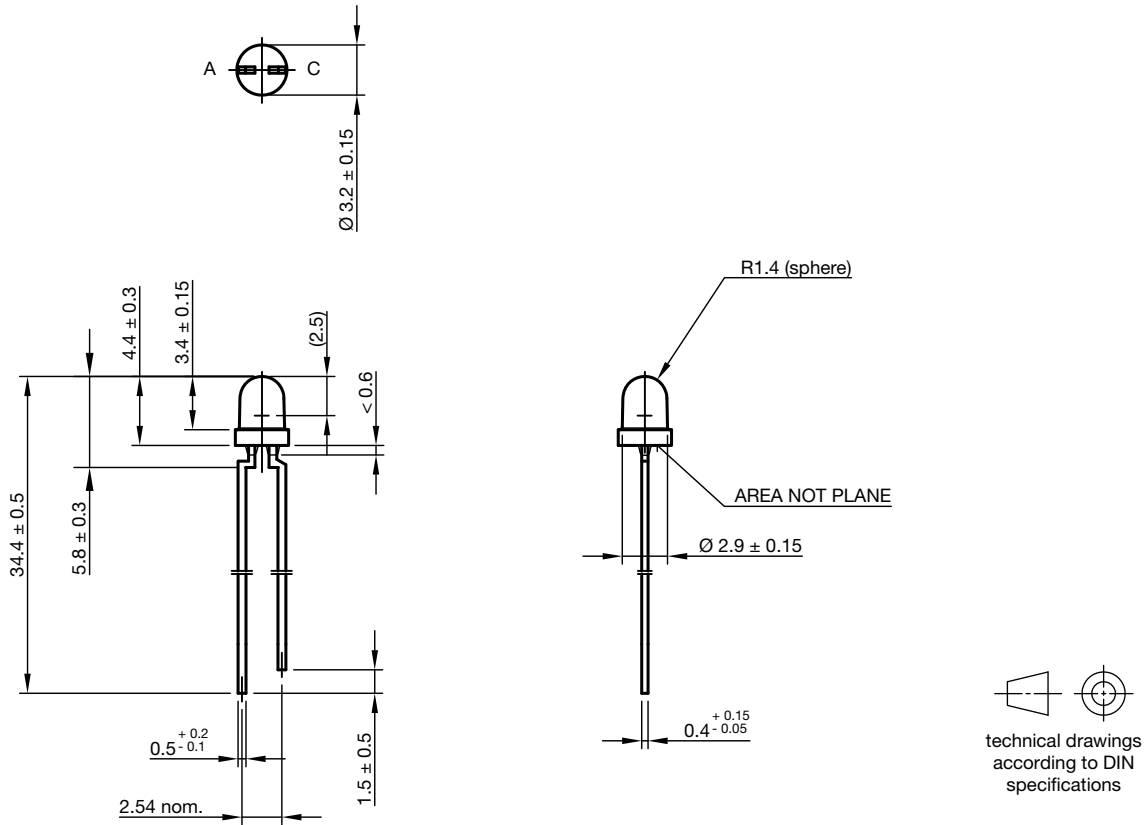

Fig. 23 - Relative Intensity vs. Wavelength



PACKAGE DIMENSIONS in millimeters



Drawing-No.: 6.544-5255.01-4
Issue: 9; 28.07.14

REEL DIMENSIONS in millimeters

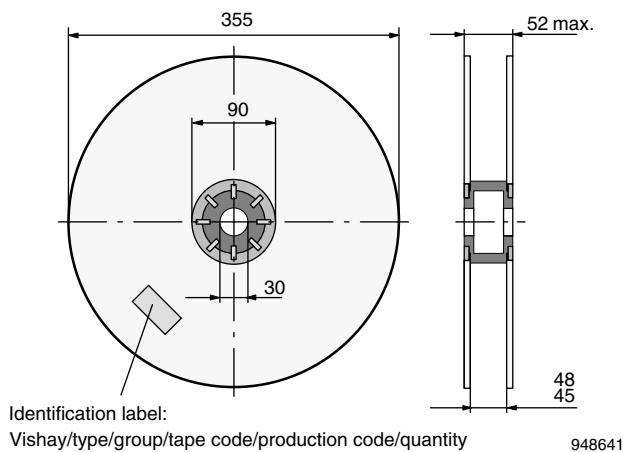

TAPE

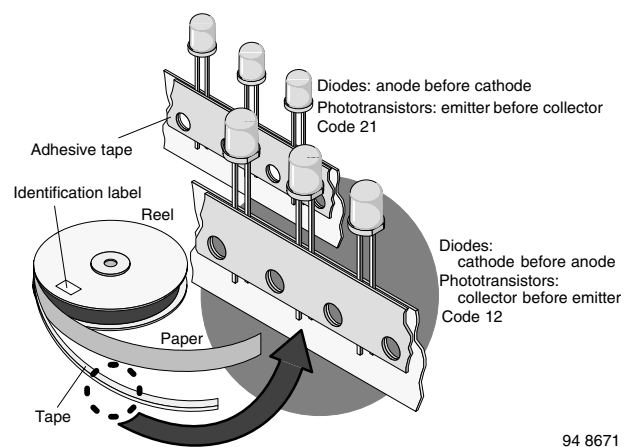

AMMOPACK (Ending: Z)

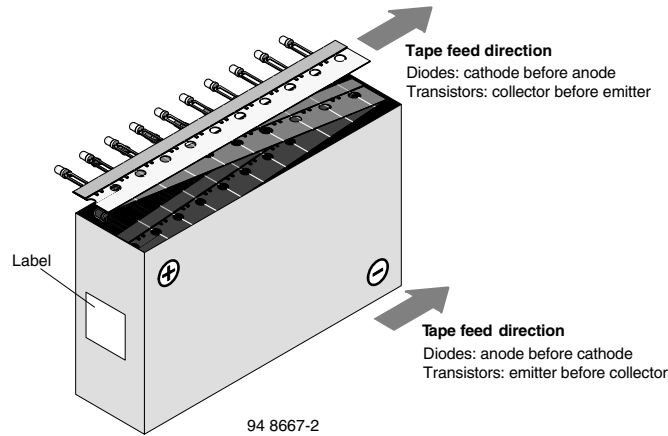

94 8667-2

Fig. 26 - Tape Direction

Note

- AS12Z and AS21Z still valid for already existing types BUT NOT FOR NEW DESIGN

TAPE DIMENSIONS in millimeters

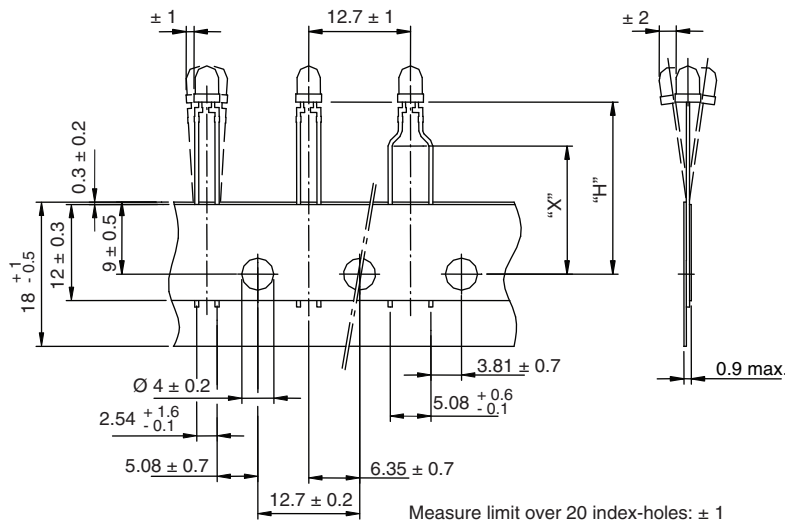

Quantity per:	Reel (Mat.-no. 1764)
	2000

21885

OPTION	DIMENSION "H" ± 0.5 mm	DIMENSION "X" ± 0.5 mm
AS	17.3	-
MS	25.5	-
CS	22.0	-
BT	20.0	16.0



Disclaimer

ALL PRODUCT, PRODUCT SPECIFICATIONS AND DATA ARE SUBJECT TO CHANGE WITHOUT NOTICE TO IMPROVE RELIABILITY, FUNCTION OR DESIGN OR OTHERWISE.

Vishay Intertechnology, Inc., its affiliates, agents, and employees, and all persons acting on its or their behalf (collectively, "Vishay"), disclaim any and all liability for any errors, inaccuracies or incompleteness contained in any datasheet or in any other disclosure relating to any product.

Vishay makes no warranty, representation or guarantee regarding the suitability of the products for any particular purpose or the continuing production of any product. To the maximum extent permitted by applicable law, Vishay disclaims (i) any and all liability arising out of the application or use of any product, (ii) any and all liability, including without limitation special, consequential or incidental damages, and (iii) any and all implied warranties, including warranties of fitness for particular purpose, non-infringement and merchantability.

Statements regarding the suitability of products for certain types of applications are based on Vishay's knowledge of typical requirements that are often placed on Vishay products in generic applications. Such statements are not binding statements about the suitability of products for a particular application. It is the customer's responsibility to validate that a particular product with the properties described in the product specification is suitable for use in a particular application. Parameters provided in datasheets and/or specifications may vary in different applications and performance may vary over time. All operating parameters, including typical parameters, must be validated for each customer application by the customer's technical experts. Product specifications do not expand or otherwise modify Vishay's terms and conditions of purchase, including but not limited to the warranty expressed therein.

Except as expressly indicated in writing, Vishay products are not designed for use in medical, life-saving, or life-sustaining applications or for any other application in which the failure of the Vishay product could result in personal injury or death. Customers using or selling Vishay products not expressly indicated for use in such applications do so at their own risk. Please contact authorized Vishay personnel to obtain written terms and conditions regarding products designed for such applications.

No license, express or implied, by estoppel or otherwise, to any intellectual property rights is granted by this document or by any conduct of Vishay. Product names and markings noted herein may be trademarks of their respective owners.

Material Category Policy

Vishay Intertechnology, Inc. hereby certifies that all its products that are identified as RoHS-Compliant fulfill the definitions and restrictions defined under Directive 2011/65/EU of The European Parliament and of the Council of June 8, 2011 on the restriction of the use of certain hazardous substances in electrical and electronic equipment (EEE) - recast, unless otherwise specified as non-compliant.

Please note that some Vishay documentation may still make reference to RoHS Directive 2002/95/EC. We confirm that all the products identified as being compliant to Directive 2002/95/EC conform to Directive 2011/65/EU.

Vishay Intertechnology, Inc. hereby certifies that all its products that are identified as Halogen-Free follow Halogen-Free requirements as per JEDEC JS709A standards. Please note that some Vishay documentation may still make reference to the IEC 61249-2-21 definition. We confirm that all the products identified as being compliant to IEC 61249-2-21 conform to JEDEC JS709A standards.