

The range of Vulcascot cable protectors are designed to prevent accidents and protect cables both for internal and external rugged applications.

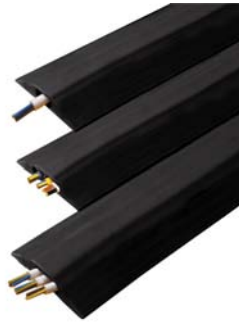

The Cable Protectors are Halogen Free and UV Stabilised. Non Conductive to BS903 - C5 500V, Fire Tested to BS476 Part 7 Class 3.

NATO codification numbers available for Defence Procurement on request.

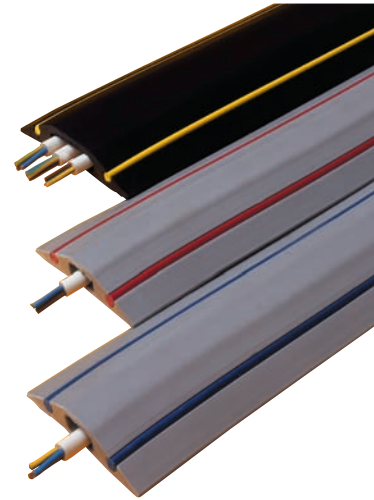

The Temporary Traffic Calmer range offers both cable protection and speed control, allowing the units to be moved and relaid with ease when required.

YOUR LOCAL SUPPLIER

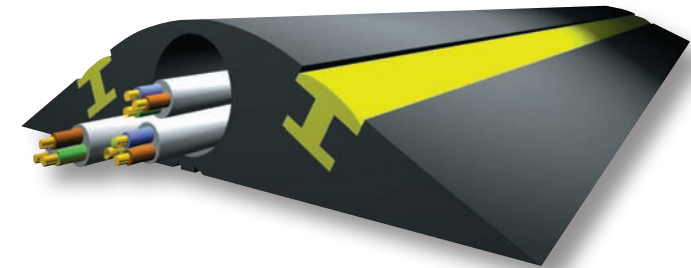

Vulcascot products are designed with low profile geometry. Cables can be inserted easily using the Snapfit, Snaptop, and cutting guides in the base of the Heavy Duty Cable Protectors.



**VULCASCOT**  
CABLE PROTECTORS LTD

Unit 12, Norman-D-Gate  
Bedford Road  
Northampton  
NN1 5NT

Tel: 0800 0352842  
Fax: 01604 632344  
International: +44 1604 212973

Email: [sales@vulcascotcableprotectors.com](mailto:sales@vulcascotcableprotectors.com)  
Web: [www.vulcascotcableprotectors.com](http://www.vulcascotcableprotectors.com)



**VULCASCOT**  
CABLE PROTECTORS LTD

**0800 0352842**



*Snap Fit* and *Snap Top* for office and domestic use, Industrial sections for rugged outdoor and warehouse applications, *Temporary Traffic Calmers*, dual purpose cable protection and speed control.

## Snap Fit™ Cable Protectors

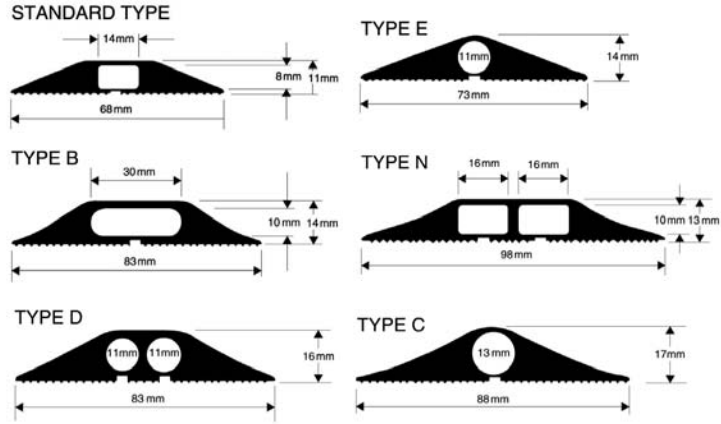

## Industrial Cable Protectors

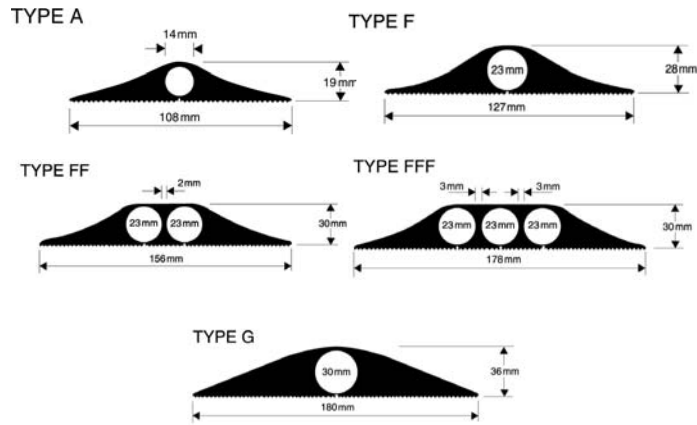

## Hazard Warning™ Cable Protectors

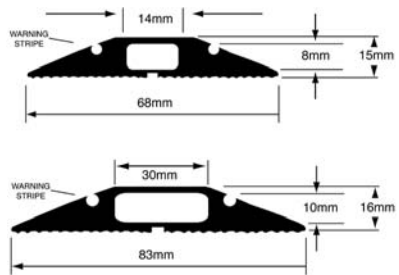

## Snap Top™ Cable Protectors

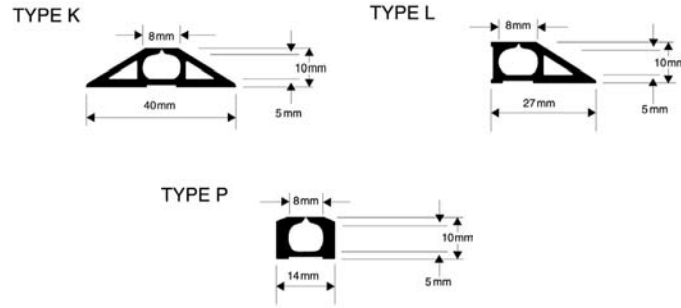

## Multi Compartment Cable Protectors

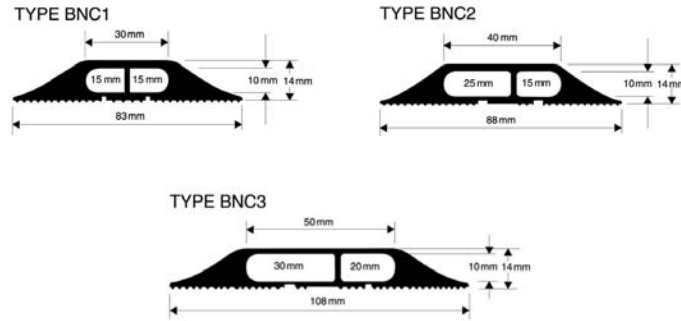

### Snapfit Type MCP/1

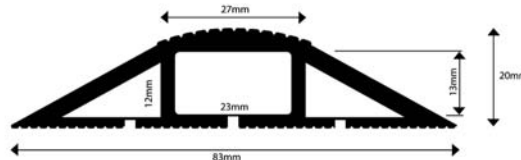

### Snapfit Type MCP/2

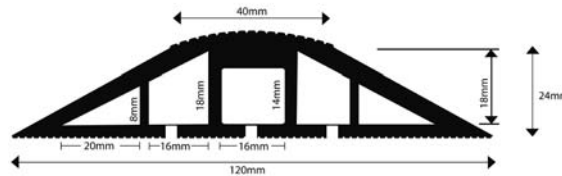

## Traffic Calmers

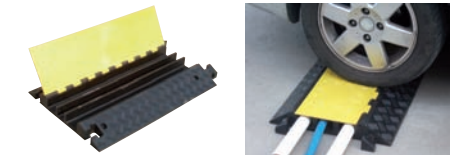

26400800

## Temporary Traffic™ Calming Cable Protectors

### TYPE TTC/1

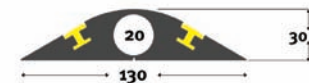

### TYPE TTC/2

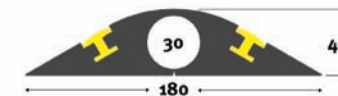

### TYPE TTC/3

