

PLEASE CHECK WWW.MOLEX.COM FOR LATEST PART INFORMATION

Part Number: [90170-0026](#)
Status: **Active**
Overview: [QF-50™](#)
Description: 2.54mm Pitch QF-50™, Strain Relief, DIN 41651, Standard Low Profile, 26 Circuits

Documents:

[3D Model](#) [Packaging Specification PK-90170-001 \(PDF\)](#)
[Drawing \(PDF\)](#) [RoHS Certificate of Compliance \(PDF\)](#)
[Product Specification PS-99020-0015 \(PDF\)](#)

General

Product Family	Ribbon Cable / Wire Trap Connectors
Series	90170
Component Type	Strain Relief
Glow-Wire Compliant	No
Overview	QF-50™
Product Name	QF-50™
UPC	800753533370

Physical

Circuits (Loaded)	N/A
Circuits (maximum)	26
Color - Resin	Black
Entry Angle	N/A
Lock to Mating Part	Yes
Material - Plating Mating	N/A
Material - Resin	Polyester
Net Weight	0.752/g
Number of Rows	2
PCB Locator	No
PCB Retention	None
Packaging Type	Bag
Pitch - Mating Interface	1.27mm
Polarized to Mating Part	No
Stackable	No
Temperature Range - Operating	-25°C to +85°C
Wire Insulation Diameter	N/A
Wire Size AWG	N/A
Wire/Cable Type	Ribbon Cable

Electrical

Current - Maximum per Contact	1A
Voltage - Maximum	250V AC/DC

Material Info

Reference - Drawing Numbers

Packaging Specification	PK-90170-001
Product Specification	PS-99020-0015
Sales Drawing	SD-90170

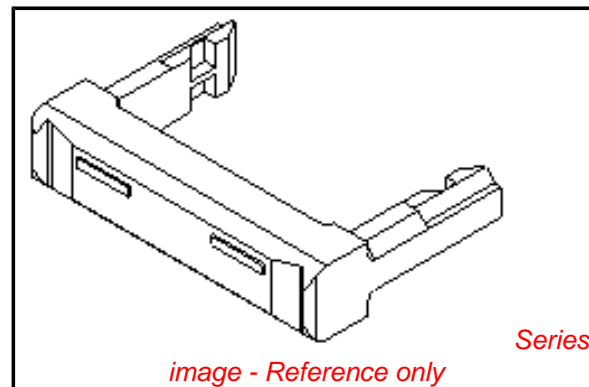

image - Reference only

EU RoHS

**ELV and RoHS
Compliant**
**REACH SVHC
Contains SVHC: No**
**Low-Halogen Status
Not Low-Halogen**

China RoHS



**Need more information on product
environmental compliance?**

Email productcompliance@molex.com
For a multiple part number RoHS Certificate of Compliance, [click here](#)

Please visit the [Contact Us](#) section for any non-product compliance questions.

Search Parts in this Series

90170Series

Use With

5320 , 90635