



# LIMIT & SAFETY SWITCHES

## 30mm Wide Limit Switches

- 30mm width
- Double insulated plastic to IP65
- Metal casing to IP66
- Snap action contacts
-   approved

CE 10



### SPECIFICATION

Rating	500V
Shock withstand	50g
Impulse withstand voltage	6kV
Working temperature	-25°C to +70°C
Switching frequency	3600 cycles/h
Load factor	0.5
Short circuit protection	10A gG fuse

IP66 METAL CASING	IP65 PLASTIC CASING	IP65 METAL HEAD PLASTIC CASING	PLUNGER TYPE	MAX ACTUATION SPEED	ACTUATION/ NC OPERATION
CE10.00.AM	CE10.00.AP	CE10.00.AI	Plain Plunger	0.5ms <sup>-1</sup>	15N/30N
CE10.00.BM	CE10.00.BP	CE10.00.BI	Roller Plunger	0.3ms <sup>-1</sup>	12N/30N
CE10.00.GM	CE10.00.GP	CE10.00.GI	Adjustable Rod Lever	1.5ms <sup>-1</sup>	0.10Nm/0.32Nm
CE10.00.HM	CE10.00.HP	CE10.00.HI	Adjustable Rod Lever	1.3ms <sup>-1</sup>	0.10Nm/0.32Nm
CE10.00.EM	CE10.00.EP	CE10.00.EI	Roller Lever Nylon	1.5ms <sup>-1</sup>	0.10Nm/0.32Nm
CE10.00.EM/50	CE10.00.EP/50	CE10.00.EI/50	Rubber Roller Lever	1.5ms <sup>-1</sup>	0.10Nm/0.32Nm
CE10.00.FM	CE10.00.FP	CE10.00.FI	Adjustable Roller Lever	1.5ms <sup>-1</sup>	0.10Nm/0.32Nm
CE10.00.FM/50	CE10.00.FP/50	CE10.00.FI/50	Adjustable Rubber Roller Lever	1.5ms <sup>-1</sup>	0.10Nm/0.32Nm
CE10.00.IM	CE10.00.IP	CE10.00.II	Nylon Roller Lever	1.5ms <sup>-1</sup>	0.10Nm/0.32Nm
CE10.00.FRM/50	CE10.00.FRP/50	CE10.00.FRII/50	Adjustable Lever Adjustable Roller	1.5ms <sup>-1</sup>	0.10Nm/-
CE10.00.HLTM	CE10.00.HLTP	CE10.00.HLTI	Nylon Actuator, Stainless Steel Spring	1.5ms <sup>-1</sup>	0.10Nm/0.32Nm

Plain Plunger

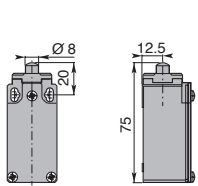

Pole Plunger

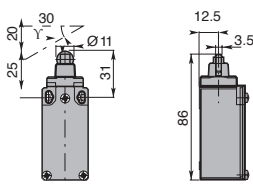

Adjustable Rod Lever

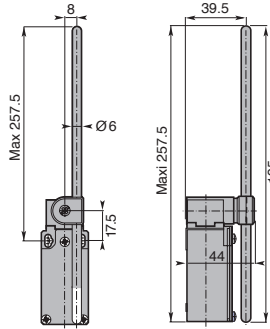

Adjustable Rod Lever

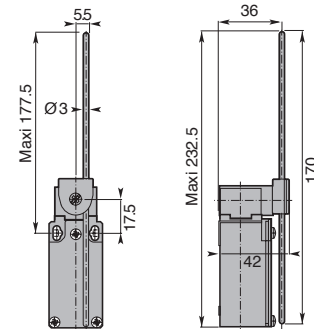

Roller Lever Nylon

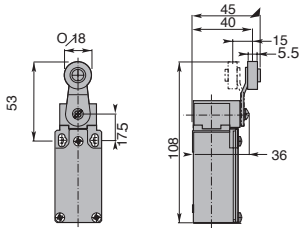

Rubber Roller Lever

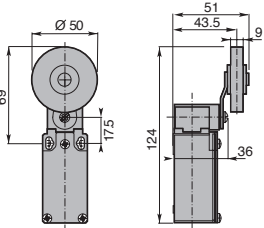

Adjustable Roller Lever

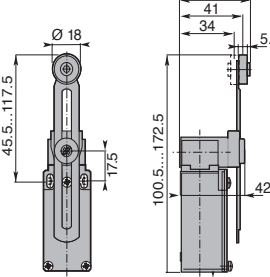

Adjustable Rubber Roller Lever

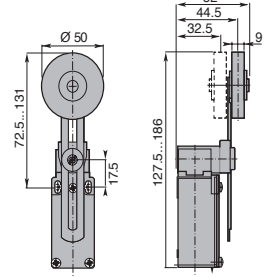

Nylon Roller Lever

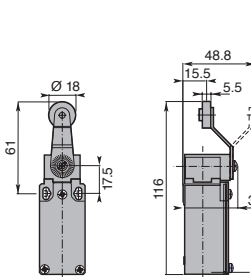

Adjustable Lever Adjustable Roller

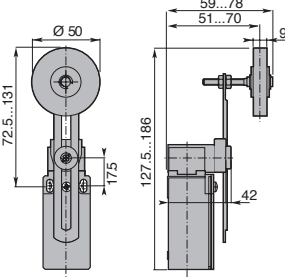

Nylon Actuator, Stainless Steel Spring

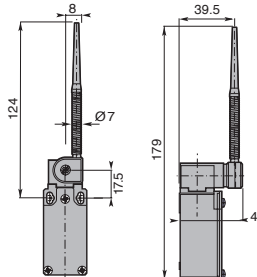

+44 (0)1638 716101  
info@camdenboss.com  
www.camdenboss.com

We operate a constant improvement policy, our products are subject to change without notice.

Ver 1.0

**CAMDENBOSS**  
ELECTRONICS & ENCLOSURES