

# SNAP Mechanical Power Relay Output Module

## Features

- Four isolated channels
- Each channel switches up to 6 A at 250 VAC or 30 VDC
- Channel-specific LEDs
- Operating temperature: -20 to 70 °C
- UL approved

## Description

The SNAP mechanical power relay output module, part number SNAP-OMR6-C, offers four channels for switching loads of up to 6 amps at 250 VAC or 30 VDC.

This module handles more current than any other SNAP output module. Each contact can carry 6 amps, and having more than one channel on at the same time does not reduce the amount of power each channel can carry.

The SNAP-OMR6-C is a form C module, so each of the four mechanical contacts can be wired as normally open or normally closed. Fusing is not provided; you must provide fusing when wiring the module.

The SNAP-OMR6-C provides channel-to-channel isolation. Because channels are not polarity sensitive, each channel can switch either AC or DC power, thus potentially reducing the number of modules needed.

In solid-state SNAP AC output modules, possible leakage current might cause an electronic input to stick in the ON state. In contrast, a channel on this mechanical power relay module presents a true open circuit when it is off. In addition, the SNAP-OMR6-C can be used exactly as a solid-state AC module is used.

*NOTE: This module may not be suitable for low-level switching.*

Part of the SNAP PAC System, the SNAP-OMR6-C mounts on a SNAP PAC rack with a SNAP PAC brain or rack-mounted controller. Analog, digital, and serial I/O modules can all be on the same rack. Such an I/O unit is also well suited for PC-based control or for use as intelligent remote I/O for an Allen-Bradley PLC system.

*NOTE: SNAP-OMR6-C modules manufactured prior to March 2014 have four black field wiring connectors; newer modules have a single large gray connector as shown above. Field connector*



SNAP-OMR6-C

*wiring and module function are identical. Note torque differences in Specifications (page 3).*

## I/O Processor Compatibility

The SNAP mechanical power relay output module is compatible with all SNAP PAC brains and rack-mounted controllers, including both standard wired models and Wired+Wireless™ models.

**Notes for legacy hardware:** This module is also compatible with SNAP Ultimate, SNAP Ethernet, and SNAP Simple brains, as well as other SNAP brains such as the serial B3000 and the B3000-B. The module can also be used on B-series and M-series mounting racks.

## SNAP-OMR6-A

A previous module, the form A SNAP-OMR6-A, is no longer available. Use the SNAP-OMR6-C as a pin-identical, drop-in replacement for this obsolete module.

Specifications and wiring diagrams for the obsolete SNAP-OMR6-A are included in this data sheet for reference only.

## Part Number

Part	Description
SNAP-OMR6-C	SNAP 4-channel Mechanical Power Relay Module, SPDT (Form C)

# SNAP Mechanical Power Relay Output Module

## Installation

The following diagram shows part of a SNAP mounting rack.

Modules snap securely into place in the row of connectors on the rack. Each module connector is numbered, starting with position zero.

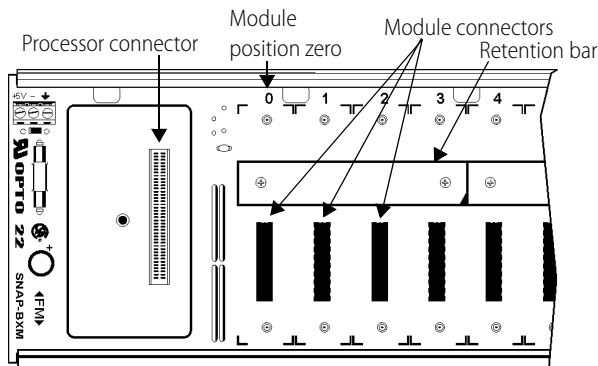

1. Place the rack so that the module connector numbers are right-side up, with zero on the left, as shown in the diagram above. (If your rack has screw connectors, the screw connectors will be at the bottom.)
 

*NOTE: Check the data sheet or user's guide for the brain or on-the-rack controller you are using to determine any restrictions on module placement.*
2. Position the module over the module connector, aligning the small slot at the base of the module with the retention bar on the rack. When positioning modules next to each other, be sure to align the male and female module keys at the tops of the modules before snapping a module into position.
3. With the module correctly aligned, push on the module to snap it into place.
4. (Optional) Use standard 4-40 x 1/2 truss-head Phillips hold-down screws (provided) to secure both sides of each module.
 

**CAUTION:** Do not over-tighten screws. Torque for hold-down screws: 4 in-lb (0.45 N-m)
5. Follow the wiring diagrams on [page 4](#) to attach the module to field devices. Torque for connector screws: 1.7 in-lb (0.2 N-m)

Modules require a special tool (provided) for removal.

# SNAP Mechanical Power Relay Output Module

## Specifications

**IMPORTANT:** Specifications for the SNAP-OMR6-A are included for reference only. This module is no longer available.

	SNAP-OMR6-C	SNAP-OMR6-A [Obsolete]
<b>Field Side Ratings (each channel)</b>		
Contact Configuration	Form C (SPDT, normally open or closed)	Form A (SPST, normally open)
Line Voltage - Range	0–250 VAC or 0–30 VDC	0–250 VAC or 0–30 VDC
Current Rating	6 amps switching @ 250 VAC / 30 VDC	6 amps switching @ 250 VAC / 30 VDC
Surge Current	6 amps	6 amps
Minimum Load	5 VDC, 10 mA	5 VDC, 10 mA
Contact Resistance	≤ 100 milliohms	≤ 100 milliohms
Switching Power	1500 VA / 144 W (DC)	1500 VA / 144 W (DC)
Peak Blocking Voltage	250 VAC / 30 VDC	250 VAC / 30 VDC
Channel-to-channel isolation	300 VAC (1500 Vtransient)	300 VAC (1500 Vtransient)
<b>Logic Side Ratings</b>		
Pickup Voltage	1 V @ 2 mA	1 V @ 2 mA
Dropout Voltage	4 VDC	4 VDC
Control Resistance	220 ohms	220 ohms
Logic Supply Voltage	5 VDC ± 0.25 VDC	5 VDC ± 0.25 VDC
Logic Supply Current	160 mA maximum	160 mA maximum
<b>Module Ratings</b>		
Number of Channels Per Module	4	4
Turn-on Time	8 milliseconds	8 milliseconds
Turn-off Time	8 milliseconds	8 milliseconds
Torque, hold-down screws	4 in-lb (0.45 N-m)	4 in-lb (0.45 N-m)
Torque, connector screws	Single gray connector: 5.26 in-lb (0.6 N-m) Black connectors: 1.7 in-lb (0.2 N-m)	Single gray connector: 5.26 in-lb (0.6 N-m) Black connectors: 1.7 in-lb (0.2 N-m)
Temperature	-20 to 70 °C, operating -30 to 85 °C, storage	-20 to 70 °C, operating -30 to 85 °C, storage
Agency Approvals	UL, CE, RoHS, DFARS	CE, RoHS, DFARS
Mechanical Life	10 x 10 <sup>6</sup> operations	10 x 10 <sup>6</sup> operations
Operational Life	30 x 10 <sup>3</sup> operations	30 x 10 <sup>3</sup> operations
Warranty	30 months	30 months

# SNAP Mechanical Power Relay Output Module

## Wiring Diagrams

SNAP-OMR6-C and SNAP-OMR6-A Field Connections - Newer Terminal (gray)

Note: User must provide own fusing.

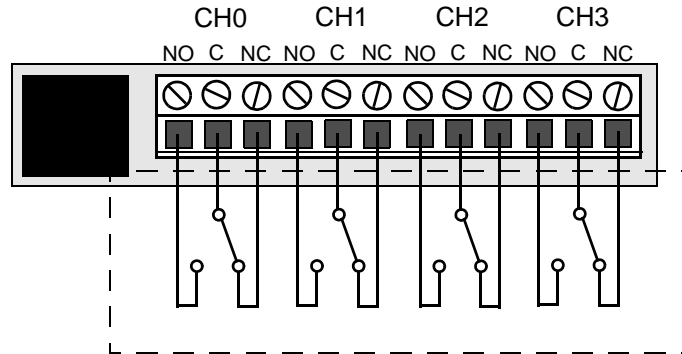

*NOTE: Transient protection must be used on inductive loads.*

SNAP-OMR6-C and SNAP-OMR6-A Field Connections - Older Terminals (black)

Note: User must provide own fusing.

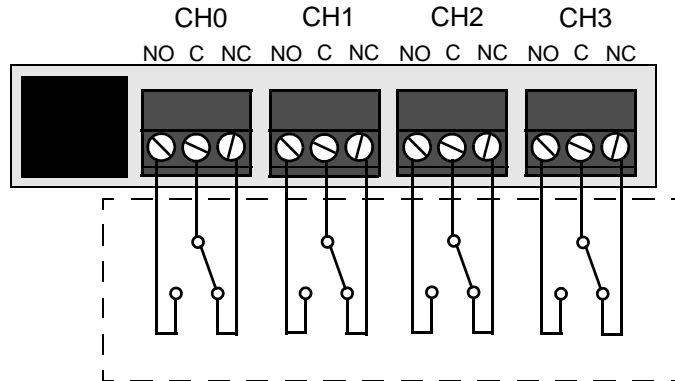

*NOTE: Transient protection must be used on inductive loads.*

# SNAP Mechanical Power Relay Output Module

## Dimensional Drawings

Newer field wiring terminal: one 12-position connector

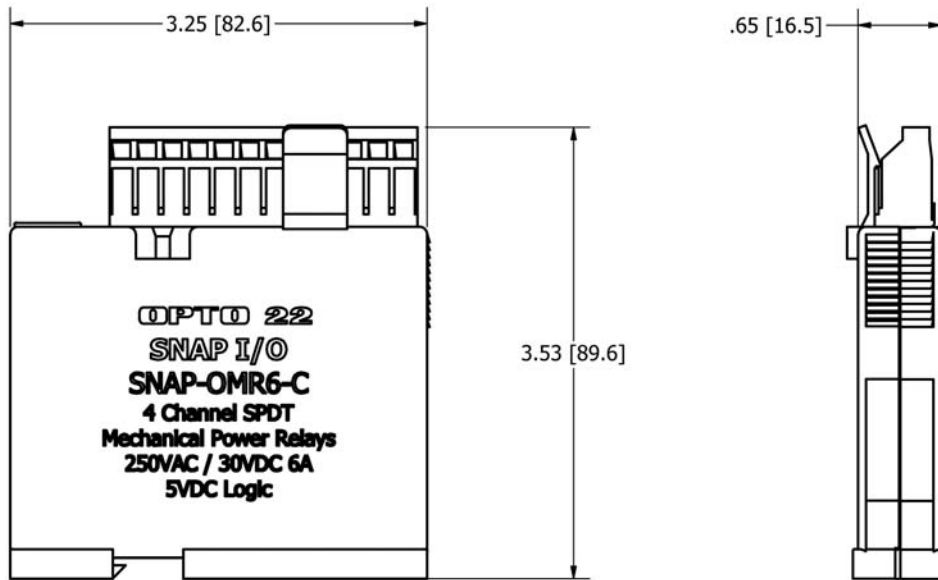

Older field wiring terminals: four 3-position connectors

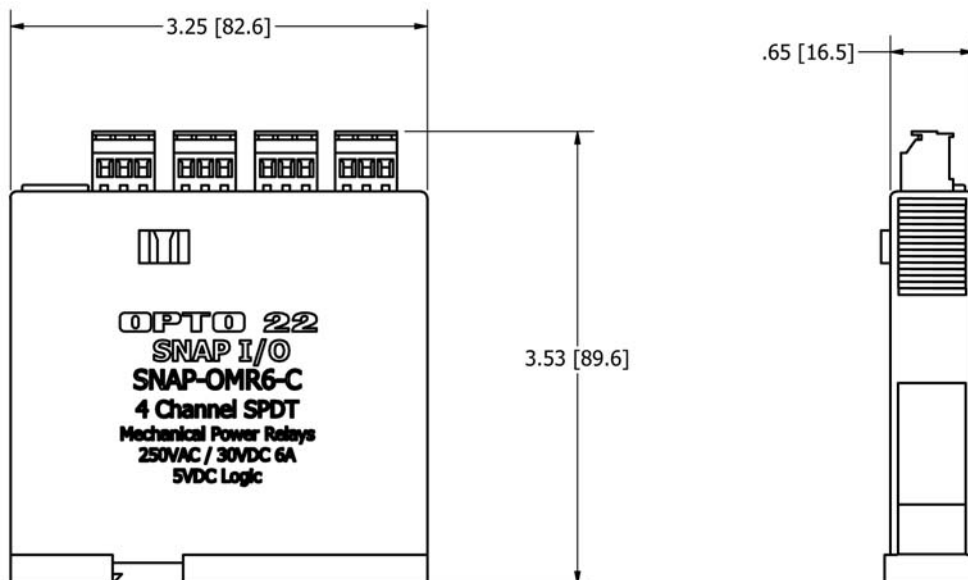

# SNAP Mechanical Power Relay Output Module

## Dimensional Drawings (Continued)

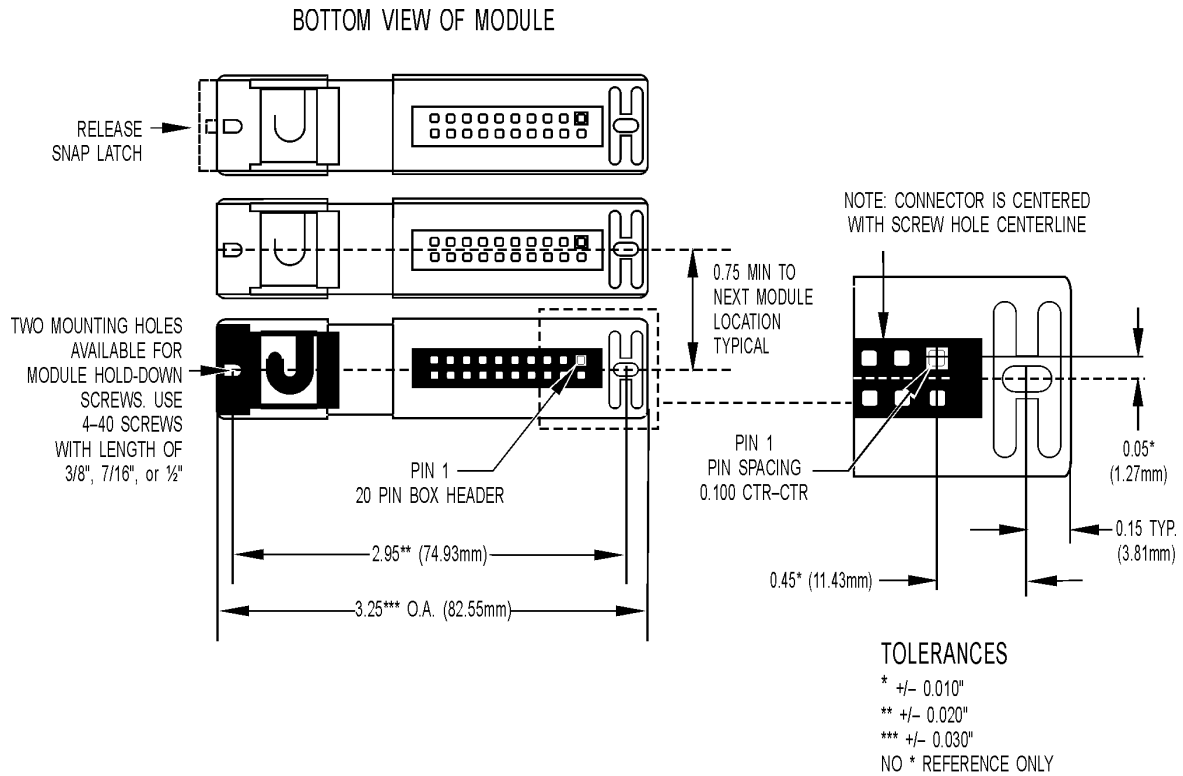

**IMPORTANT:** The mounting rack connector has 24 pins; the module connector has 20 pins. The extra pins on the mounting rack connector prevent misalignment of the module during installation.

# SNAP Mechanical Power Relay Output Module

## Dimensional Drawings (Continued)

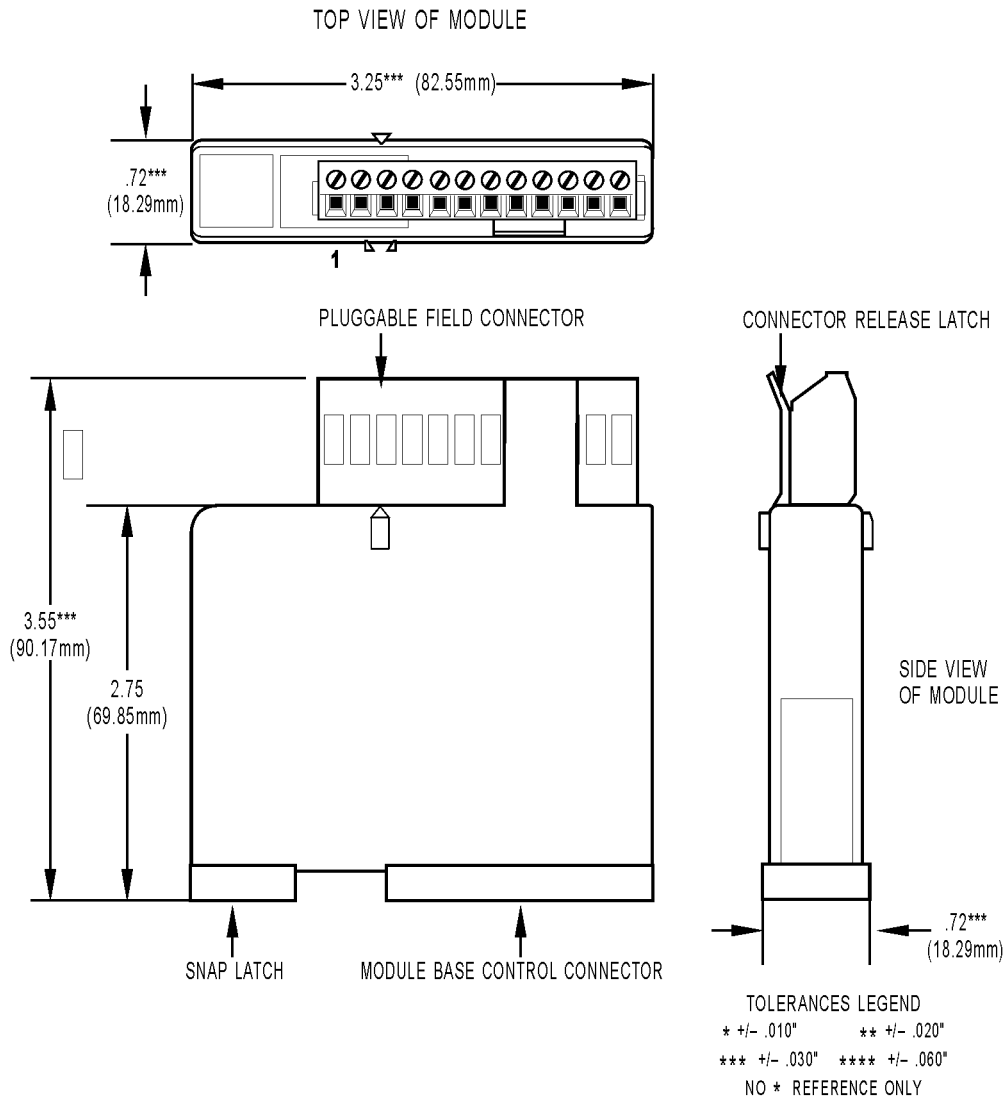

## More About Opto 22

### Products

Opto 22 develops and manufactures reliable, flexible, easy-to-use hardware and software products for industrial automation, energy management, remote monitoring, and data acquisition applications.

#### groov

groov puts your system on your mobile device. With zero programming, you can build mobile operator interfaces to monitor and control systems from Allen-Bradley, Siemens, Schneider Electric, Modicon, and many more. Web-based groov puts mobile-ready gadgets at your fingertips. Tag them from your existing tag database, and they automatically scale for use on any device with a modern web browser. See [groov.com](http://groov.com) for more information and your free trial.

#### SNAP PAC System

Designed to simplify the typically complex process of selecting and applying an automation system, the SNAP PAC System consists of four integrated components:

- SNAP PAC controllers
- PAC Project™ Software Suite
- SNAP PAC brains
- SNAP I/O™

#### SNAP PAC Controllers

Programmable automation controllers (PACs) are multifunctional, modular controllers based on open standards.

Opto 22 has been manufacturing PACs for over two decades. The standalone SNAP PAC S-series, the rack-mounted SNAP PAC R-series, and the software-based SoftPAC™ all handle a wide range of digital, analog, and serial functions for data collection, remote monitoring, process control, and discrete and hybrid manufacturing.

SNAP PACs are based on open Ethernet and Internet Protocol (IP) standards, so you can build or extend a system easily, without the expense and limitations of proprietary networks and protocols. Wired+Wireless™ models are also available.

#### PAC Project Software Suite

Opto 22's PAC Project Software Suite provides full-featured, cost-effective control programming, HMI (human machine interface) development and runtime, OPC server, and database connectivity software for your SNAP PAC System.

Control programming includes both easy-to-learn flowcharts and optional scripting. Commands are in plain English; variables and I/O point names are fully descriptive.

PAC Project Basic offers control and HMI tools and is free for download on our website, [www.opto22.com](http://www.opto22.com). PAC Project

Professional, available for separate purchase, adds one SoftPAC, OptoOPCServer, OptoDataLink, options for controller redundancy or segmented networking, and support for legacy Opto 22 serial *mistic*™ I/O units.

#### SNAP PAC Brains

While SNAP PAC controllers provide central control and data distribution, SNAP PAC brains provide distributed intelligence for I/O processing and communications. Brains offer analog, digital, and serial functions, including thermocouple linearization; PID loop control; and optional high-speed digital counting (up to 20 kHz), quadrature counting, TPO, and pulse generation and measurement.

#### SNAP I/O

I/O provides the local connection to sensors and equipment. Opto 22 SNAP I/O offers 1 to 32 points of reliable I/O per module, depending on the type of module and your needs. Analog, digital, and serial modules are all mixed on the same mounting rack and controlled by the same processor (SNAP PAC brain or rack-mounted controller).

### Quality

Founded in 1974, Opto 22 has established a worldwide reputation for high-quality products. All are made in the U.S.A. at our manufacturing facility in Temecula, California. Because we test each product twice before it leaves our factory, rather than only testing a sample of each batch, we can guarantee most solid-state relays and optically isolated I/O modules for life.

### Free Product Support

Opto 22's California-based Product Support Group offers free, comprehensive technical support for Opto 22 products. Our staff of support engineers represents decades of training and experience. Support is available in English and Spanish by phone or email, Monday–Friday, 7 a.m. to 5 p.m. PST.

Additional support is always available on our website: how-to videos, OptoKnowledgeBase, self-training guide, troubleshooting and user's guides, and OptoForums.

In addition, hands-on training is available for free at our Temecula, California headquarters, and you can [register online](#).

### Purchasing Opto 22 Products

Opto 22 products are sold directly and through a worldwide network of distributors, partners, and system integrators. For more information, contact Opto 22 headquarters at 800-321-6786 or 951-695-3000, or visit our website at [www.opto22.com](http://www.opto22.com).



[www.opto22.com](http://www.opto22.com)