



Features

- RoHS compliant*
- Low capacitance ~ 2.5 pF
- ESD protection
- Surge protection

Applications

- Personal Digital Assistants (PDAs)
- Mobile phones & accessories
- Memory card protection
- SIM card port protection
- Portable electronics

CDSOT23-SLVU2.8 - Surface Mount TVS Diode

General Information

The CDSOT23-SLVU2.8 device provides ESD, EFT and Surge protection for high speed data ports meeting IEC 61000-4-2 (ESD), IEC 61000-4-4 (EFT) and IEC 61000-4-5 (Surge) requirements. The Transient Voltage Suppressor Array offers a Working Peak Reverse Voltage of 2.8 V and Minimum Breakdown Voltage of 3 V.

The SOT23 packaged device will mount directly onto the industry standard SOT23 footprint. Bourns® Chip Diodes conform to JEDEC standards, are easy to handle with standard pick and place equipment and the flat configuration minimizes roll away.

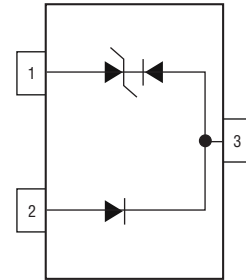

Electrical Characteristics (@ T_A = 25 °C Unless Otherwise Noted)

Parameter	Symbol	Value	Unit
Peak Pulse Power (t _p = 8/20 μs) ¹	P _{PK}	600	W
Peak Pulse Current (t _p = 8/20 μs)	I _{PPM}	30	A
Storage Temperature	T _{STG}	-55 to +150	°C
Operating Temperature	T _{OPR}	-55 to +150	°C
Minimum Breakdown Voltage @ 1 mA	V _{BR}	3.0	V
Minimum Snap Back Voltage @ 50 mA	V _{BR}	2.8	V
Maximum Working Peak Voltage	V _{WM}	2.8	V
Maximum Leakage Current @ V _{WM} (Pin 3 to Pin 1) or (Pin 2 to Pin 1)	I _D	1.0	μA
Maximum Clamping Voltage @ I _p = 2 A	V _C	5.5	V
Maximum Clamping Voltage @ I _p = 5 A (Pin 2 to Pin 1)	V _C	7.0 8.5	V
Maximum Clamping Voltage @ I _p = 30 A	V _C	21.0	V
Typical Junction Capacitance @ 0 V, 1 MHz (Pin 3 to Pin 1 & Pin 2) (Pin 2 to Pin 1 with Pin 3 NC)	C _D	20 2.5	pF
Maximum Junction Capacitance @ 0 V, 1 MHz	C _D	3	pF
Maximum Peak Reverse Voltage @ I = 10 μA	V _{RRM}	40	V
Maximum Reverse Leakage Current @ V _{WM}	I _{DR}	0.1	μA
Maximum Forward Voltage @ I _F = 1 A, 120 μS	V _F	2	V

Note:

1. See Peak Pulse Power vs. Pulse Time.

*RoHS Directive 2002/95/EC Jan. 27, 2003 including annex and RoHS Recast 2011/65/EU June 8, 2011.

Specifications are subject to change without notice.

The device characteristics and parameters in this data sheet can and do vary in different applications and actual device performance may vary over time. Users should verify actual device performance in their specific applications.

CDSOT23-SLVU2.8 - Surface Mount TVS Diode



Product Dimensions

This is a molded JEDEC SOT-323 package with 100 % Matte Sn plating on the lead frame. It weighs approximately 8 mg and has a flammability rating of UL 94V-0.

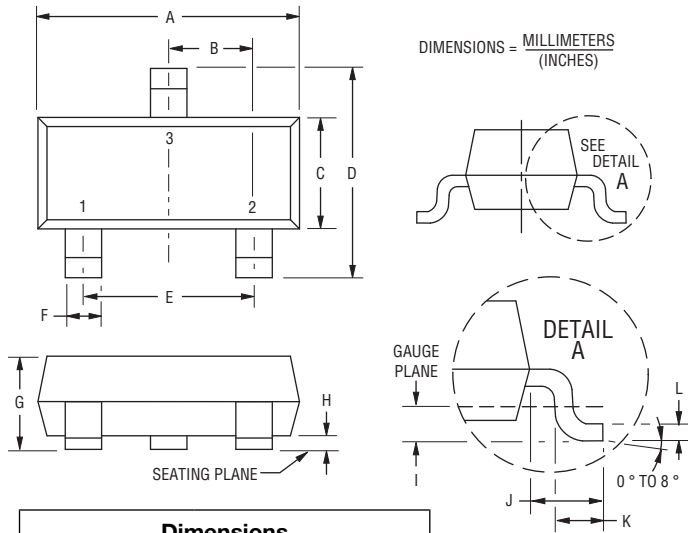

Dimensions	
A	$\frac{2.80 - 3.00}{(0.110 - 0.118)}$
B	$\frac{0.95}{(0.037)}$ BSC
C	$\frac{1.20 - 1.40}{(0.047 - 0.055)}$
D	$\frac{2.10 - 2.49}{(0.083 - 0.098)}$
E	$\frac{1.90}{(0.075)}$ BSC
F	$\frac{0.30 - 0.50}{(0.012 - 0.019)}$
G	$\frac{0.89 - 1.17}{(0.035 - 0.046)}$
H	$\frac{0.05 - 0.015}{(0.002 - 0.006)}$
I	$\frac{0.25}{(0.010)}$ BSC
J	$\frac{0.46 - 0.64}{(0.018 - 0.025)}$
K	$\frac{0.40 - 0.58}{(0.016 - 0.023)}$
L	$\frac{0.08 - 0.20}{(0.003 - 0.008)}$

Recommended Footprint

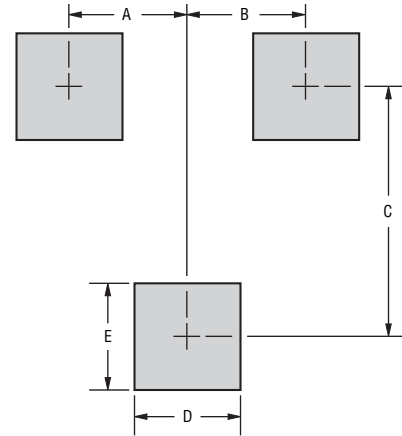

Dimensions	
A	$\frac{0.95}{(0.037)}$
B	$\frac{0.95}{(0.037)}$
C	$\frac{2.00}{(0.079)}$
D	$\frac{0.85}{(0.033)}$
E	$\frac{0.85}{(0.033)}$

How to Order

CD SOT23 - SLVU 2.8

Common Code _____
 Chip Diode _____
 Package _____
 • SOT23 = SOT23 Package
 Model _____
 SLVU = Special Model
 Working Peak Reverse Voltage _____
 2.8 = 2.8 V_{RWM} (Volts)

Typical Part Marking

CDSOT23-SLVU2.8SLA

Specifications are subject to change without notice. The device characteristics and parameters in this data sheet can and do vary in different applications and actual device performance may vary over time. Users should verify actual device performance in their specific applications.

CDSOT23-SLVU2.8 - Surface Mount TVS Diode

BOURNS®

Performance Graphs

Peak Pulse Power vs. Pulse Time

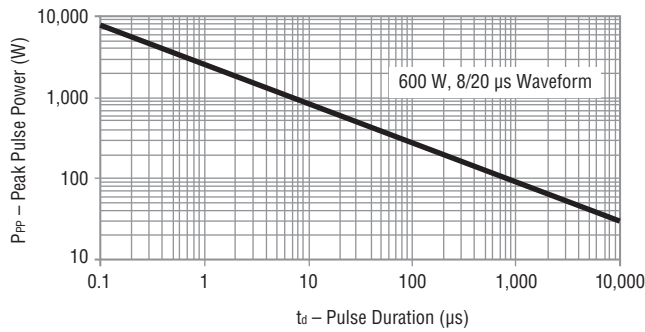

Pulse Waveform

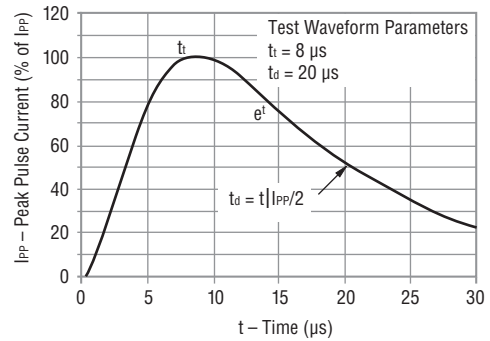

Overshoot & Clamping Voltage

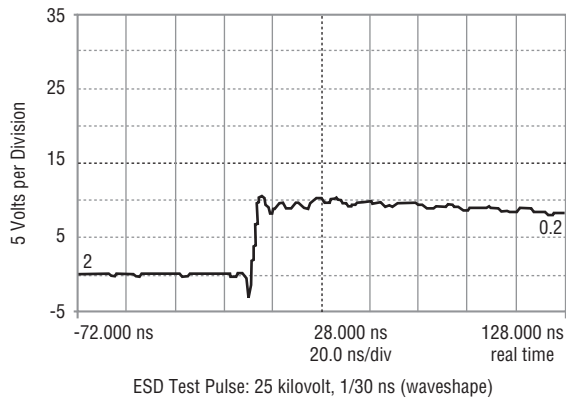

Power Derating Curve

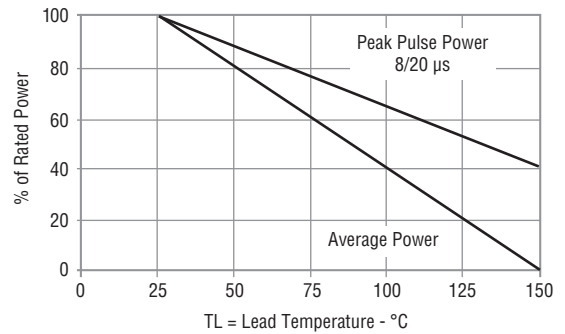

Specifications are subject to change without notice.

The device characteristics and parameters in this data sheet can and do vary in different applications and actual device performance may vary over time. Users should verify actual device performance in their specific applications.

CDSOT23-SLVU2.8 - Surface Mount TVS Diode

BOURNS®

Packaging Information

The surface mount product is packaged in an 8 mm x 4 mm tape and reel format per EIA-481 standard.

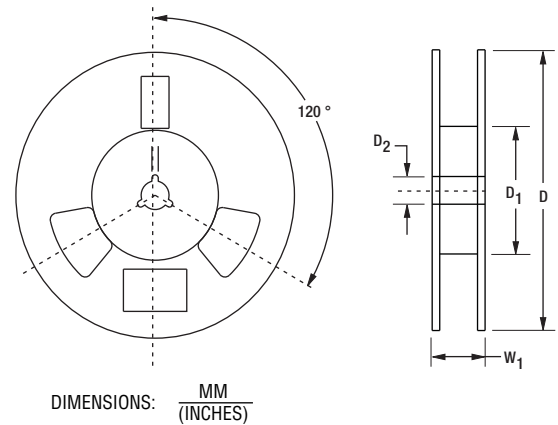
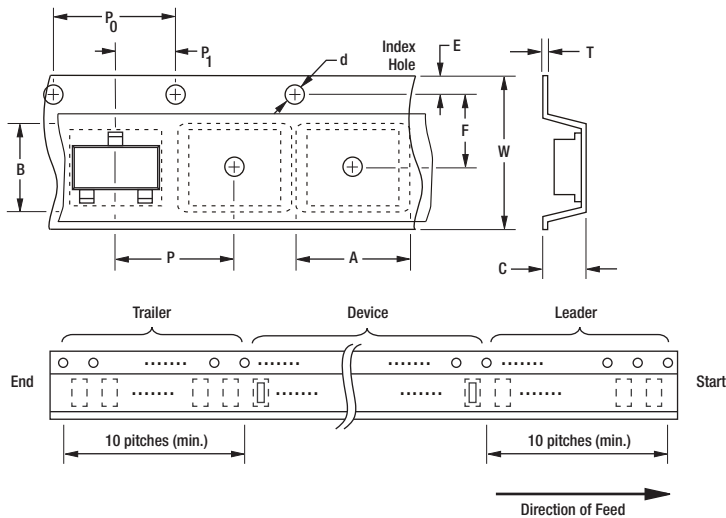

Devices are packed in accordance with EIA standard RS-481-A.

Item	Symbol	SOT23
Carrier Width	A	$\frac{2.25 \pm 0.10}{(0.088 \pm 0.004)}$
Carrier Length	B	$\frac{2.34 \pm 0.10}{(0.092 \pm 0.004)}$
Carrier Depth	C	$\frac{1.22 \pm 0.10}{(0.048 \pm 0.004)}$
Sprocket Hole	d	$\frac{1.55 \pm 0.05}{(0.061 \pm 0.002)}$
Reel Outside Diameter	D	$\frac{178}{(7.008)}$
Reel Inner Diameter	D ₁	$\frac{50.0}{(1.969)}$ MIN.
Feed Hole Diameter	D ₂	$\frac{13.0 \pm 0.20}{(0.512 \pm 0.008)}$
Sprocket Hole Position	E	$\frac{1.75 \pm 0.10}{(0.069 \pm 0.004)}$
Punch Hole Position	F	$\frac{3.50 \pm 0.05}{(0.138 \pm 0.002)}$
Punch Hole Pitch	P	$\frac{4.00 \pm 0.10}{(0.157 \pm 0.004)}$
Sprocket Hole Pitch	P ₀	$\frac{4.00 \pm 0.10}{(0.157 \pm 0.004)}$
Embossment Center	P ₁	$\frac{2.00 \pm 0.05}{(0.079 \pm 0.002)}$
Overall Tape Thickness	T	$\frac{0.20 \pm 0.10}{(0.008 \pm 0.004)}$
Tape Width	W	$\frac{8.00 \pm 0.20}{(0.315 \pm 0.008)}$
Reel Width	W ₁	$\frac{14.4}{(0.567)}$ MAX.
Quantity per Reel	--	3,000

BOURNS®

Asia-Pacific:

Tel: +886-2 2562-4117
Fax: +886-2 2562-4116

EMEA:

Tel: +36 88 520 390
Fax: +36 88 520 211

The Americas:

Tel: +1-951 781-5500
Fax: +1-951 781-5700

www.bourns.com

REV. 11/13

Specifications are subject to change without notice. The device characteristics and parameters in this data sheet can and do vary in different applications and actual device performance may vary over time. Users should verify actual device performance in their specific applications.