

C-Series Commercial
Pin & Sleeve Devices

**HUBBELL**

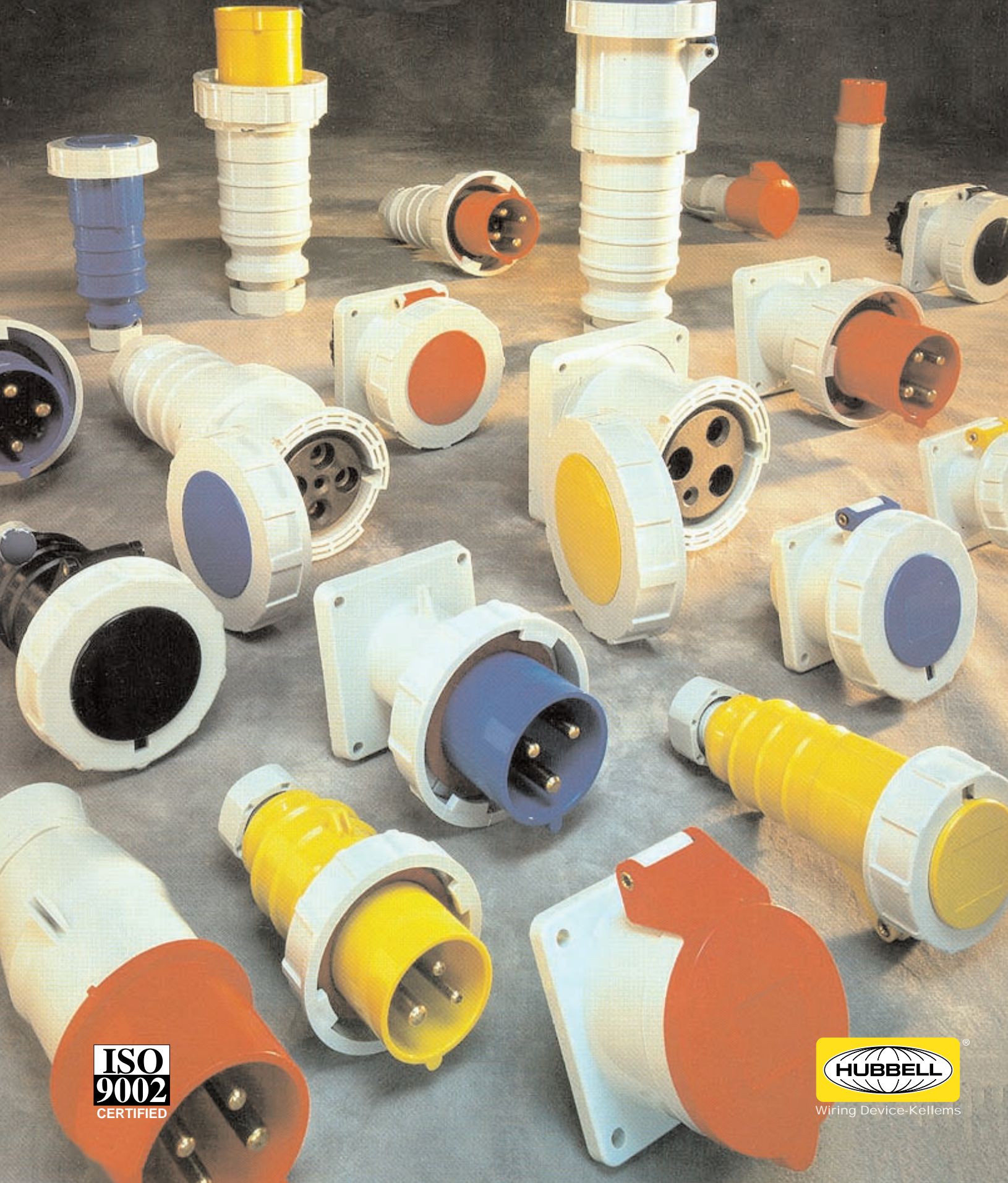

**ISO
9002**
CERTIFIED



Wiring Device-Kellems

C-Series - A New Generation of Pin & Sleeve Devices



Hubbell now offers a complete line of commercial grade pin and sleeve wiring devices. Safety, durability, performance, and positive locking are all essential to you. But so is economy. Where the application calls for a light-industrial wiring device designed and constructed with safety in mind, Hubbell C-Series pin and sleeve devices are the answer.

The North American devices are available in 20, 30, 60, and 100 Amp watertight configurations while the European devices are available in 16,32,63, and 125 Amp watertight and splashproof configurations.

An airtight case for a watertight pin and sleeve.

Often, pin and sleeve devices are used in applications where water is present and that can make short work of an unprotected device. To minimize that risk, C-Series is designed with features that make them watertight.

For example, the self-closing, gasketed cover on the receptacle and connector body seats to provide a weatherproof seal and makes a watertight seal when locked. The plug and inlet are watertight when connected to a mating device and locked with the locking ring or closure cap.

Furthermore, neoprene glands provide a reliable watertight connection at the cable entry point. The same protective features make the C-Series pin and sleeve device dust tight, as well as watertight to reduce the risk of contamination by metal filings or dust.

A watertight pin and sleeve that holds tight, too.

To protect the internal wire termination, the new C-Series pin and sleeve devices feature an internal cable grip which can handle a wide variety of cable sizes to prevent conductor movement and strain on the terminals.

But we didn't stop there.

A tough pin and sleeve device has to withstand more than just external impact. It also has to withstand possible internal heat build-up. To meet this requirement, the C-Series devices utilize a glass filled nylon contact carrier. The result: interiors that resist arcing and prevent damage in the event of heat build-up due to overloads.

The C-Series also incorporates solid brass pins and sleeves combined with stainless steel components to improve overall corrosion resistance.

Hubbell Safe

The C-Series devices are designed and built to conform to IEC 309-2, the worldwide pin and sleeve standard established by the International Electrotechnical Commission. This is a uniform system that makes the mating of plugs and receptacles of different voltages and current ratings physically impossible as required by the National Electrical Code.

C-Series devices are color coded according to voltage rating and female grounding contact position. Within a particular voltage group, every plug and the weatherproof cap on every receptacle is identical in color. All 250 VAC devices are blue, all 480 VAC devices are red, etc.

As shown, a clock face is used to represent the ground sleeve position for all receptacles. With the keyway at the bottom, the female grounding sleeve will appear at one of the twelve "hour" positions. Using this system, it is easy to identify the system voltage for any plug and receptacle. This standard calls out a singly rated non-interchangeable configuration for every voltage and type of service throughout the world.

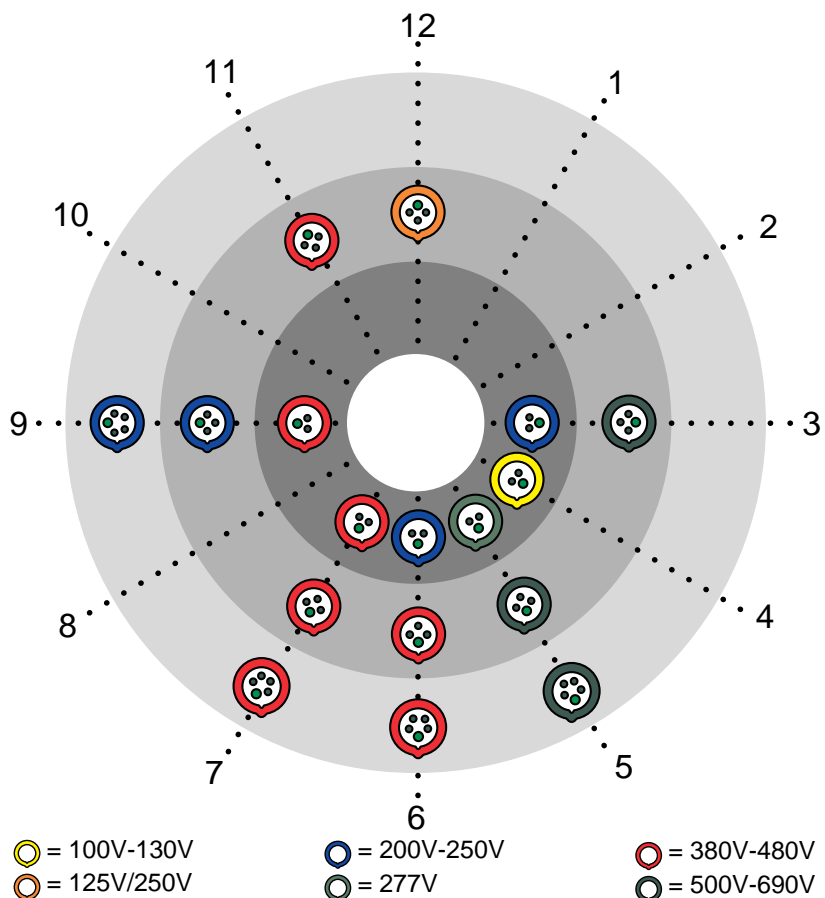



Features and Benefits

Terminal identification - the ground and neutral terminals are clearly identified with large color coded markings for easy recognition.

Watertight multi-diameter sealing glands - for use with varying cable sizes insure a highly reliable seal at the cable entry to the device.

Insulated housing - tough nylon provides increased safety and maximum impact and abuse resistance.

Gasketed cover and locking ring - The self-closing cover sits in a position that provides a weatherproof seal. Simply rotating the cover then locking it makes it watertight

Solid pins - dependable solid pin construction provides for long life and reliable electrical contact.

Cable grip - internal strain relief protects the wiring by preventing conductor movement which can cause strain on terminals. The internal cable grip is designed to swing out of the way for easier wiring.

Staggered contacts - in female devices to assure protection of personnel and equipment. Oversized ground contact is farthest forward, assuring first make and last break of the ground for safety. Neutral contact is next to prevent the possibility of an "open neutral" condition that could result in an over-voltage condition at equipment. Phase contact is farthest back, making it last to make, first to break.

Shrouding - protects pins from impact and abuse.

Color coding - all devices are color coded by voltage for quick visual identification of mating devices.

Product identification - every device is marked with its respective catalog number and rating for ease in identification.

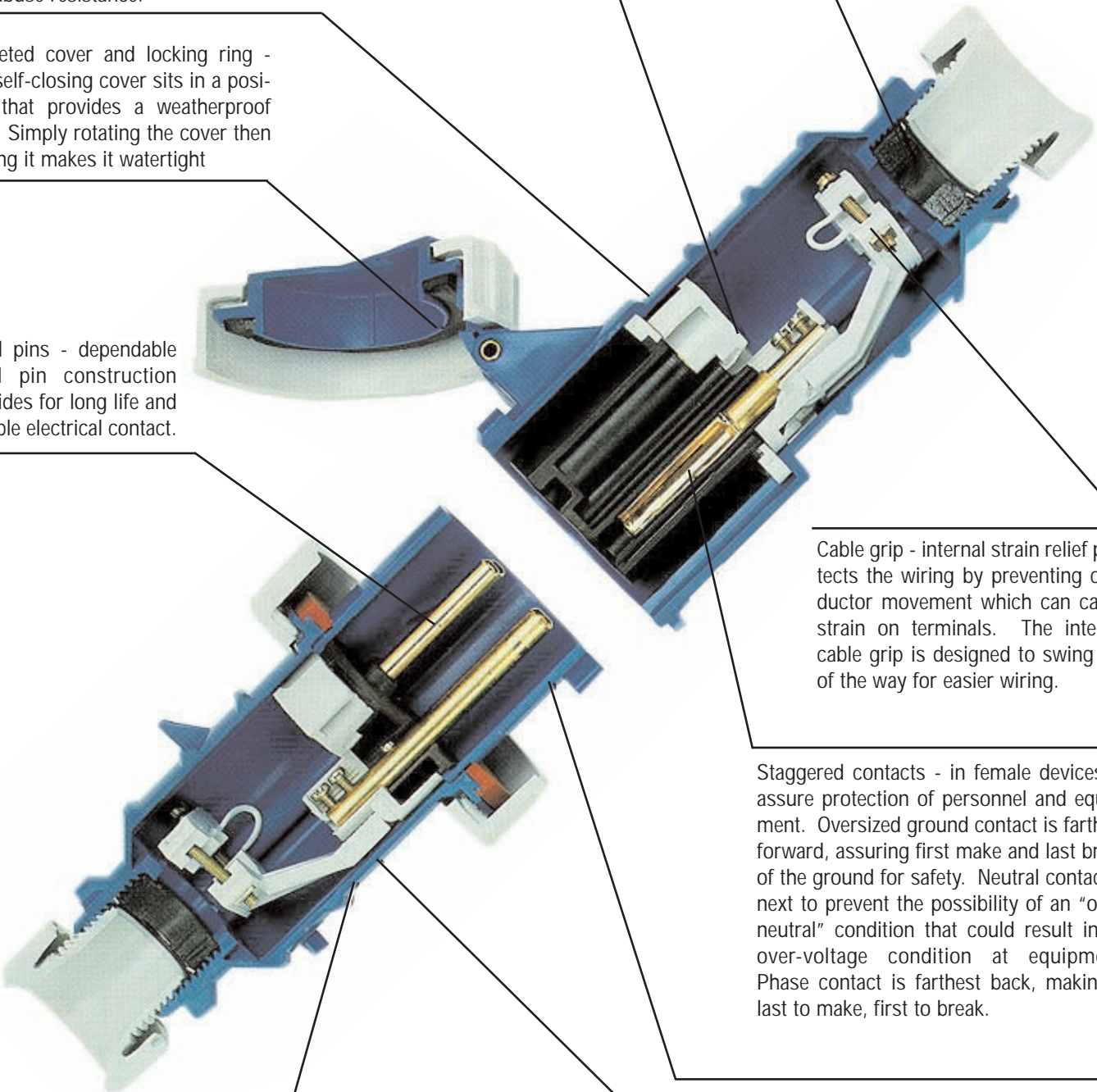



Watertight Devices Ordering Information

Pin and Sleeve C-Series

20 through 100 Ampere – North American Ratings

16 through 125 Ampere – International Ratings

IP67					Watertight Devices			Back Boxes			
Amps	Poles and Wires	Configuration Recep./ Conn.	Plug/ Inlet	Voltage	 Receptacle	 Plug	 Connector	 Cord Dia. inches MIN. MAX.	 Nonmetallic	 Metallic	 Adapter Plate
16	2P3W			200-250	C316R6W	C316P6W	C316C6W	.365-.625	BB2030N*	SP20301	CAP2030
	4P5W			200/346 240/415	C516R6W	C516P6W	C516C6W	.365-.625	BB2030N*	SP20301	CAP2030
20	2P3W			125	C320R4W	C320P4W	C320C4W	.365-.625	BB2030N*	SP20301	CAP2030
	2P3W			250	C320R6W	C320P6W	C320C6W	.365-.625	BB2030N*	SP20301	CAP2030
	3P4W			125/250	C420R12W	C420P12W	C420C12W	.365-.625	BB2030N*	SP20301	CAP2030
	3P4W			3Ø250	C420R9W	C420P9W	C420C9W	.365-.625	BB2030N*	SP20301	CAP2030
	3P4W			3Ø480	C420R7W	C420P7W	C420C7W	.365-.625	BB2030N*	SP20301	CAP2030
	3P4W			3Ø600	C420R5W	C420P5W	C420C5W	.365-.625	BB2030N*	SP20301	CAP2030
	30	2P3W			250	C330R6W	C330P6W	C330C6W	.565-.95	BB2030N*	SP20301
20	2P3W			480	C330R7W	C330P7W	C330C7W	.565-.95	BB2030N*	SP20301	CAP2030
	3P4W			3Ø250	C430R9W	C430P9W	C430C9W	.565-.95	BB2030N*	SP20301	CAP2030
	3P4W			3Ø480	C430R7W	C430P7W	C430C7W	.565-.95	BB2030N*	SP20301	CAP2030
	3P4W			3Ø600	C430R5W	C430P5W	C430C5W	.565-.95	BB2030N*	SP20301	CAP2030
	4P5W			3ØY120/208	C530R9W	C530P9W	C530C9W	.565-.95	BB2030N*	SP20301	CAP2030
	4P5W			3ØY277/480	C530R7W	C530P7W	C530C7W	.565-.95	BB2030N*	SP20301	CAP2030
32	2P3W			200-250	C332R6W	C332P6W	C332C6W	.565-.95	BB2030N*	SP20301	CAP2030
	3P4W			380V 50Hz 440V 60Hz	C432R3W	C432P3W	C432C3W	.565-.95	BB2030N*	SP20301	CAP2030
	4P5W			200/346 240/415	C532R6W	C532P6W	C532C6W	.565-.95	BB2030N*	SP20301	CAP2030
60	3P4W			3Ø250	C460R9W	C460P9W	C460C9W	.78-1.40	BB60N*	SP602	CAP60
	3P4W			3Ø480	C460R7W	C460P7W	C460C7W	.78-1.40	BB60N*	SP602	CAP60
	3P4W			3Ø600	C460R5W	C460P5W	C460C5W	.78-1.40	BB60N*	SP602	CAP60
	4P5W			3ØY120/208	C560R9W	C560P9W	C560C9W	.78-1.40	BB60N*	SP602	CAP60
63	4P5W			200/346 240/415	C563R6W	C563P6W	C563C6W	.78-1.40	BB60N*	SP602	CAP60
100	3P4W			125/250	C4100R12W	C4100P12W	C4100C12W	.92-1.72	BB100N*	BB1001W*	CAP100
	3P4W			3Ø250	C4100R9W	C4100P9W	C4100C9W	.92-1.72	BB100N*	BB1001W*	CAP100
	3P4W			3Ø480	C4100R7W	C4100P7W	C4100C7W	.92-1.72	BB100N*	BB1001W*	CAP100
	3P4W			3Ø600	C4100R5W	C4100P5W	C4100C5W	.92-1.72	BB100N*	BB1001W*	CAP100
	4P5W			3ØY120/208	C5100R9W	C5100P9W	C5100C9W	.92-1.72	BB100N*	BB1001W*	CAP100
125	4P5W			200/346 240/415	C5125R6W	C5125P6W	C5125C6W	.92-1.72	BB100N*	BB1001W*	CAP100

* Adapter plate required



Dimensions - Watertight Devices

(inch/mm)

Plugs	A	B	C	D	E
C320P	2.75 70.5	4.37 112	5.42 139	4.11 105.5	0.62 16
C420P	3.04 78	4.37 112	5.42 139	4.11 105.5	0.62 16
C520P	3.37 86.5	4.60 118	5.66 145	4.35 111.5	0.62 16
C330P, C430P	3.67 94	5.62 144	6.67 171	4.95 127	0.88 22.5
C530P	3.96 101.5	5.62 144	6.67 171	4.95 127	0.88 22.5
C360P, C460P, C560P	4.43 113.5	8.81 226	9.91 254	7.49 192	1.43 36.5
C3100P, C4100P, C5100P	4.88 125	9.87 253	11.15 286	8.39 215	1.72 44

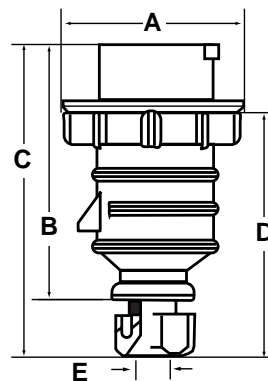

(inch/mm)

Connectors	A	B	C	D
C320C	2.75 70.5	5.97 153	3.00 77	0.62 16
C420C	3.04 78	5.97 153	3.24 83	0.62 16
C520C	3.37 86.5	6.20 159	3.63 93	0.62 16
C330C, C430C	3.67 94	7.33 188	3.86 99	0.88 22.5
C530C	3.96 101.5	7.33 188	4.17 107	0.88 22.5
C360C, C460C, C560C	4.29 110	10.61 272	4.43 113.5	1.42 36.5
C3100C, C4100C	4.91 126	12.01 308	4.99 128	1.72 44
C5100C	4.91 126	12.01 308	4.99 128	1.72 44

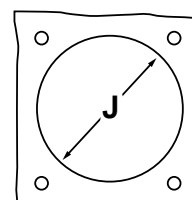
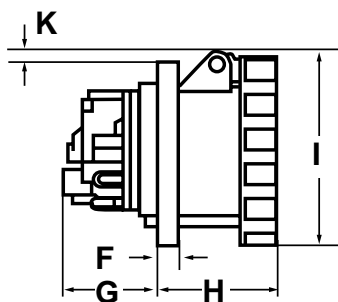
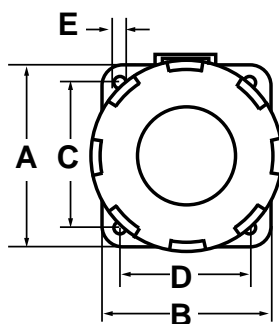
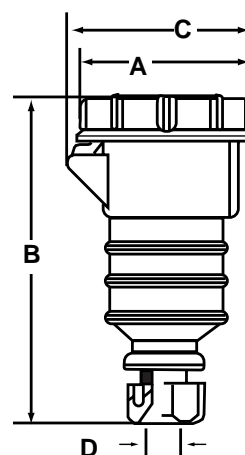

(inch/mm)

Receptacles	A	B	C	D	E	F	G	H	I	J	K
C320R	2.93 75	2.93 75	2.34 60	2.34 60	0.22 5.5	0.27 7	0.66 17	2.22 57	2.96 76	1.76 45	0.14 3.5
C420R	2.93 75	2.93 75	2.34 60	2.34 60	0.22 5.5	0.27 7	1.01 26	2.26 58	3.24 83	1.76 45	0.27 7
C520R	2.93 75	2.93 75	2.34 60	2.34 60	0.22 5.5	0.27 7	0.66 17	2.22 57	3.63 93	2.15 55	0.45 11.5
C330R, C430R	2.93 75	2.93 75	2.34 60	2.34 60	0.22 5.5	0.31 8	1.40 36	2.54 65	3.90 100	2.34 60	0.47 12
C530R	2.93 75	2.93 75	2.34 60	2.34 60	0.22 5.5	0.31 8	0.74 19	2.54 65	3.90 100	2.34 60	0.66 17
C360R, C460R, C560R	4.17 107	3.9 100	3.32 85	3.00 77	0.25 6.5	0.47 12	2.20 56.5	2.96 76	4.41 113	3.43 88	0.27 7
C3100R, C4100R, C5100R	4.68 120	4.68 120	3.90 100	3.90 100	0.25 6.5	0.82 21	1.95 50	4.56 117	5.03 129	3.28 84	0.23 6

Ordering Information / Dimensions - Splashproof Devices



					Splashproof Devices			Back Boxes			
Amps	Poles and Wires	Configuration Recep./ Conn.	Plug/ Inlet	Voltage	Receptacle	Plug	Connector	Cord Dia. inches	Nonmetallic	Metallic	Adapter Plate
16	2P3W			100-130	C316R4S	C316P4S	C316C4S	.365-.625	BB2030N*	SP20301	CAP2030
	2P3W			200-250	C316R6S	C316P6S	C316C6S	.365-.625	BB2030N*	SP20301	CAP2030
	4P5W			200/346 240/415	C516R6S	C516P6S	C516C6S	.365-.625	BB2030N*	SP20301	CAP2030
32	2P3W			100-130	C332R4S	C332P4S	C332C4S	.565-.95	BB2030N*	SP20301	CAP2030
	2P3W			200-250	C332R6S	C332P6S	C332C6S	.565-.95	BB2030N*	SP20301	CAP2030
	4P5W			200/346 240/415	C532R6S	C532P6S	C532C6S	.565-.95	BB2030N*	SP20301	CAP2030

* Adapter plate required

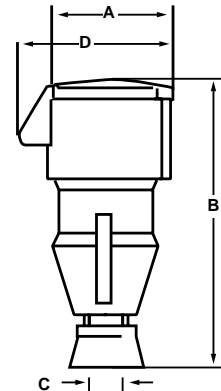
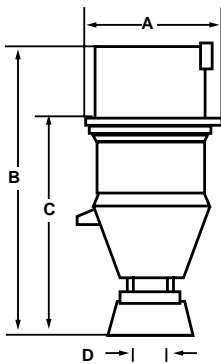

(inch/mm)

Plugs	A	B	C	D
C316P	1.99	5.38	3.98	0.66
	51	138	102	17
C516P	2.5	5.58	4.17	0.66
	64	143	107	17
C332P	2.57	6.83	5.07	0.96
	66	175	130	24.5
C532P	2.85	6.86	5.11	.96
	73	176	131	24.5

(inch/mm)

Connectors	A	B	C	D
C316C	1.99	5.85	0.66	2.77
	51	150	17	71
C516C	2.50	6.05	0.66	3.32
	64	155	17	85
C332C	2.57	7.33	0.96	3.63
	66	188	24.50	93
C532C	2.81	7.37	.96	3.86
	72	189	24.5	99

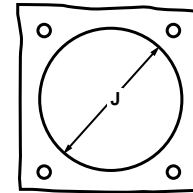
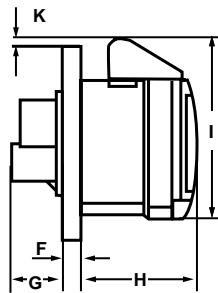
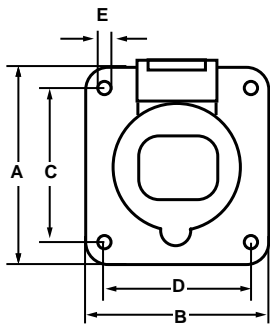

(inch/mm)

Receptacles	A	B	C	D	E	F	G	H	I	J	K
C316R	2.93	2.93	2.34	2.34	0.22	0.27	0.66	1.99	2.73	1.76	0.40
	75	75	60	60	5.5	7	17	51	70	45	3.5
C516R	2.93	2.93	2.34	2.34	0.21	0.27	0.66	2.07	3.32	2.15	.45
	75	75	60	60	5.5	7	17	53	85	55	11.5
C332R	2.93	2.93	2.34	2.34	0.21	0.31	1.40	2.42	3.51	2.34	.47
	75	75	60	60	5.5	8	36	62	90	60	12
C532R	2.93	2.93	2.34	2.34	.21	.31	.74	2.42	3.82	2.34	.47
	75	75	60	60	5.5	8	19	62	98	60	17

Accessories



Nonmetallic Back Box

This Hubbell back box is made of a high grade engineered thermoplastic that meets IP67 requirements. It resists chemicals, abuse and UV rays. What's more, this box has an integral grounding plate and, when installed with a watertight conduit hub, it meets Type 4X requirements (hose-directed water, corrosion resistance).



Description	Hub Size Inch (mm)	A Inch (mm)	B Inch (mm)	C Inch (mm)	D Inch (mm)	E Inch (mm)	F Inch (mm)	Cubic Inch Capacity	Catalog Number
Back box for 20 & 30A devices.	1*	5.67	4.44 (144.0)	4.05 (112.8)	3.91 (102.9)	2.35 (59.3)	4.92 (125.0)	30	BB2030N
Back box for 60A devices.	1 1/4**	7.76	5.16 (157.8)	5.87 (149.0)	4.72 (119.9)	2.99 (76.0)	6.94 (176.0)	70	BB60N
Back box for 100A devices.	1 1/2***	8.21	6.23 (158.2)	6.31 (160.3)	5.71 (145.0)	3.99 (101.0)	7.41 (188.0)	120	BB100N

* Hub is not included; order one of the following Racor part numbers: * 1" = 1704, ** 1 1/4 = 1705, *** 1 1/2 = 1706

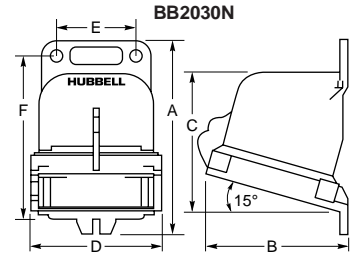

Adapter Plate

Adapter plate allows receptacles and inlets to be mounted to nonmetallic back boxes

Description	Catalog Number
20, 30, 16, 32 Amp Adapter Plate	CAP2030
60, 63 Amp Adapter Plate	CAP60
100, 125 Amp Adapter Plate	CAP100

Adapter Plate thickness .375

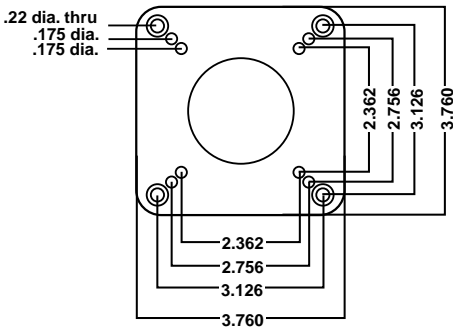

CAP2030

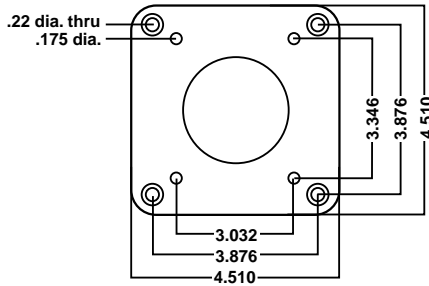

CAP60

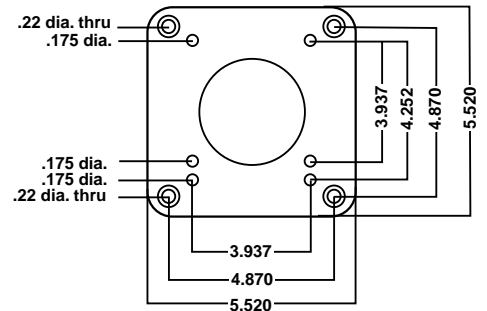

CAP100

Metallic Back Boxes, Back Box Dimensions

Description	Hub Size	A Inch (mm)	B Inch (mm)	C Inch (mm)	D Inch (mm)	Catalog Number
15° angle for 20A & 30A	3/4"	5.07 130	3.38 87	4.13 106	3.62 93	SP20301
15° angle for 60A	1 1/4"	5.81 149	4.28 110	4.56 117	4.58 117	SP602
15° angle for 100A	1 1/2"	8.38 215	6.75 173	6.88 176	5.50 141	BB1001W*

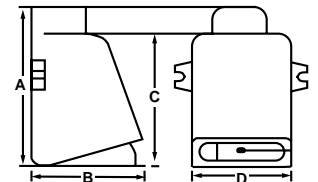

Note: All metal boxes are made of cast aluminum, *Adapter plate required

Closure Caps

Cap assemblies provide watertight sealing to a disconnected male Pin and Sleeve plug or inlet. Manufactured out of the same tough nonmetallic material as the watertight Pin and Sleeve Size devices for corrosion and abuse resistance.

Description	Catalog Number
Fits all 20A 3 wire plugs and inlets	PC320
Fits all 20A 4 wire plugs and inlets	PC420
Fits all 20A 5 wire plugs and inlets	PC520
Fits all 30A 3 and 4 wire plugs and inlets	PC3430
Fits all 30A 5 wire plugs and inlets	PC530
Fits all 60A plugs and inlets	PC60
Fits all 100A plugs and inlets	PC100



Specifications



Listed to UL Standard 1682 & 1686

Certified to CSA Standard C22.2 Number 182.1 (Industrial-type, Special-use Attachment Plugs, Receptacles and Connectors).

Watertight and Splashproof Materials

Part	Material
Plug	
Housing	Nylon.
Locking Ring	Polycarbonate.
Gasket & Seals	Neoprene, EPDM, TPE, Silicone.
Cord Clamp Assembly	Nylon.
Gland Nut	Nylon.
Assembly Screws	Stainless Steel (300 Series)(20, 30A, Plated Steel).
Contact Carrier	Reinforced Nylon (60A Nylon).
Retainer	Reinforced Nylon
Ground, Phase Pins	Brass.
Terminal	Plated Steel.
Receptacle	
Housing	Nylon.
Mounting Flange	Nylon.
Cover Arm	Nylon.
Cover	Polycarbonate.
Cover Rivet	Brass.
Cover Spring	Stainless Steel (300 Series).
Gaskets & Seals	Neoprene, EPDM, TPE, Silicone.
Mounting Screws	Stainless Steel (300 Series).
Terminal Screw	Plated Steel.
Phase, Ground Sleeves	Brass.
Contact Carrier & Retainer	Reinforced Nylon (60A Nylon)
Connector Body	
Housing	Nylon.
Cord Clamp Assembly	Nylon.
Gland Nut	Nylon.
Cover Arm	Nylon.
Cover	Polycarbonate.
Cover Rivet	Brass.
Cover Spring	Stainless Steel (300 Series).
Gaskets & Seals	Neoprene, EPDM, TPE, Silicone.
Contact Carrier	Reinforced Nylon (60A Nylon).
Retainer	Reinforced Nylon.
Phase, Ground Sleeves	Brass.
Terminal	Plated Steel
Assembly Screws	Stainless Steel (300 Series) (20, 30A Plated Steel)



® Wiring Device - Kellems

Hubbell Incorporated (Delaware) • 185 Plains Road • Milford, CT 06460-2420 • (203) 882-4800 • FAX (800) 255-1031
World Wide Web URL: <http://www.hubbell-wiring.com>

Worldwide Locations

Hubbell Canada (905) 839-1138, Fax (905) 839-9108
Hubbell Ltd. England (441) 234-855444, Fax (441) 234-854008
Hubbell-Taian Co., Ltd., (886) 2 567-5995, Fax (886) 2 567-4853
Hubbell Int'l. Inc., Korea Branch (82) 2 607-1362, Fax (82) 2 603-7386

Hubbell de Mexico, S.A. de C.V. (52) 5 575-2022, Fax (52) 5 559-8626
Caribe Sales Agencies, Puerto Rico (809) 720-7185, Fax (809) 789-2796
Hubbell S.E. Asia Pte., Ltd., 65-4544772, Fax 65-4544775
Hubbell Inc. Middle East (971) 4 369-763, Fax (971) 4 360-541