

## ENVIRONMENTALLY SEALED TOGGLE

The T9 Toggle Switch is an ideal switch for demanding applications. Qualified to MIL-DTL-3950, this high performance switch is a logical choice for use in environments where sealing and resistance to shock and vibration are required. The T9 is particularly suitable for applications in military, off-highway, aviation, commercial and industrial equipment. This compact, environmentally sealed switch is available in single and double pole configurations with a lever lockout option. Circuitry configurations include two or three positions with many combinations of OFF-ON in momentary and maintained action including ON-ON-ON.

### Features:

- Qualified to MIL-DTL-3950
- Commercial version is sealed per IP68S
- Lever lockout option available
- UL, CSA & CE approvals (pending)
- Maintained & momentary toggle action
- Optional panel seal
- RoHS/WEEE/Reach compliant
- Black matte finish available. Contact factory.



### Standard Characteristics/Ratings:

**ELECTRICAL RATINGS:** See Product Family Table

**Electrical Life:** 20,000 cycles

**Mechanical Life:** 40,000 cycles

**Seal:** IP68S

**Operating Temp Range:** -65°C to +71°C

### MATERIALS:

**Toggle:** Stainless steel, passivated

**Bushing & Cover:** Aluminum, clear anodized or zinc alloy

**Case:** Thermoset plastic

**Terminal Hardware:** Included

**Mounting Hardware:** Hex nuts, lockwasher, keyway washer, 0.138-32 UNC-2A screw with lockwasher

### T9 PART NUMBER CODE

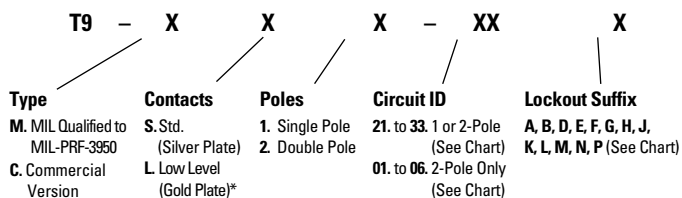

\* Available in commercial only.

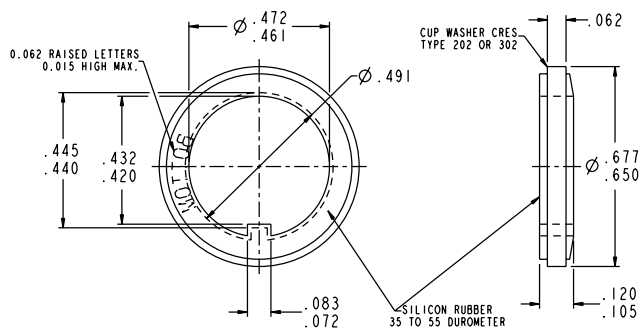

Optional Panel Seal P/N 710196, MIL. P/N M5423/16-01

### Lever Lockout Configuration Codes

Figures A thru P are schematics to illustrate lockout configurations and momentary positions. They do not represent details of construction.

- A** Locked in all three positions
- B** Locked in Center and Keyway Side position
- D** Locked out of Center position
- E** Locked in Center position
- F** Locked in Opposite Keyway position
- G** Locked in Keyway Side position
- H** Locked out of Center and Keyway Side position
- J** Locked out of Center and Opposite Keyway position
- K** Locked in Center and Opposite Keyway position
- L** Locked out of Keyway Side position
- M** Locked out of and into Opposite Keyway position
- N** Locked out of Opposite Keyway position
- P** Locked out of and into Keyway Side position

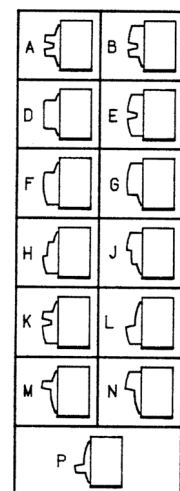

## PRODUCT FAMILY TABLE

### Single Pole

.469-32 UNS-2A THREAD TO WITHIN .060 OF MOUNTING SURFACE

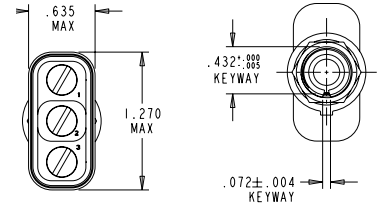
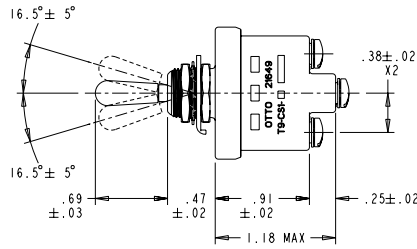
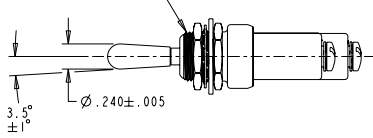

Low level 10mA @ 30mV (commercial version only)

OTTO PART NO.	MILITARY NO.	DASH NO.	CIRCUIT BY TOGGLE LEVER POSITION			ELECTRICAL RATINGS - SEA LEVEL & 65,000 FT					
			KEYWAY 1-2	CENTER	OPP. KEYWAY 2-3	28 VDC			115 VAC		
						LAMP	RESISTIVE	INDUCTIVE	LAMP	RESISTIVE	INDUCTIVE
T9-MSI-	MS24523-	21	ON	OFF	ON	5	20	15	3	15	10
		22	OFF	NONE	ON						
		23	ON	NONE	ON						
		24	NONE	OFF	ON						
		25	NONE	MOM OFF	ON						
		26	MOM ON	NONE	ON	4	15	10	2	15	7
		27	MOM ON	OFF	MOM ON						
		28	MOM ON	OFF	NONE						
		29	MOM OFF	NONE	ON						
		30	MOM ON	NONE	OFF						
		31	MOM ON	OFF	ON						
OTTO PART NO.	MILITARY NO.	DASH NO.	KEYWAY	CENTER 1-2	OPP. KEYWAY 2-3	28 VDC			115 VAC		
T9-MSI-	MS24523-	32	NONE	ON	MOM ON	4	15	10	2	15	7
		33	NONE	ON	ON	5	20	15	3	15	10

### Lever/Lock Single Pole

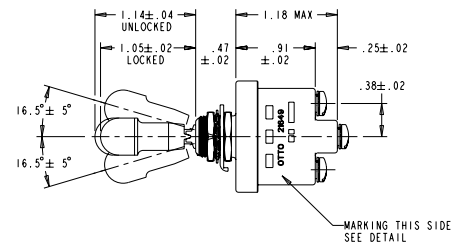
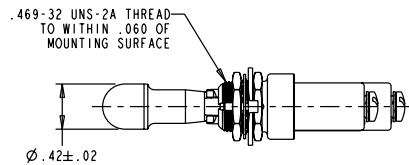
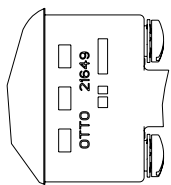
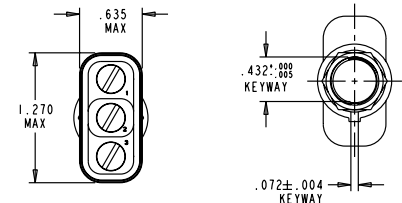
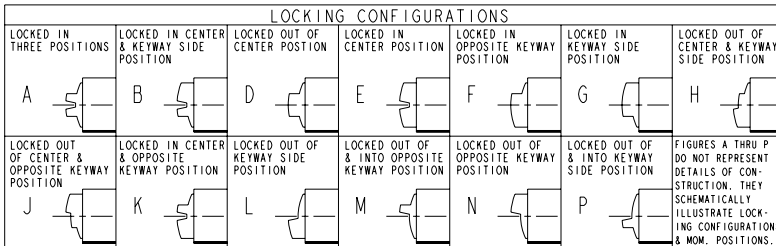

OTTO BASE PART NO.	MILITARY NO.	DASH NO.	AVAILABLE LOCKOUTS (SEE CHART)	CIRCUIT BY TOGGLE LEVER POSITION			ELECTRICAL RATINGS - SEA LEVEL & 65,000 FT					
				KEYWAY 1-2	CENTER	OPP. KEYWAY 2-3	28 VDC			115 VAC		
							LAMP	RESISTIVE	INDUCTIVE	LAMP	RESISTIVE	INDUCTIVE
T9-MSI-	MS24658-	21	ALL	ON	OFF	ON	5	20	15	3	15	10
		22	D F G	OFF	NONE	ON						
		23	D F G	ON	NONE	ON						
		24	E F K M	NONE	OFF	ON						
		25	F	NONE	OFF (M)	ON						
		26	F	MOM ON	NONE	ON	4	15	10	2	15	7
		27	E L N	MOM ON	OFF	MOM ON						
		28	E	MOM ON	OFF	NONE						
		29	F	MOM OFF	NONE	ON						
		30	F	MOM ON	NONE	OFF						
				31	E F K L M N	MOM ON	OFF	ON				
OTTO BASE NO.	MILITARY NO.	DASH NO.	AVAILABLE LOCKOUT	KEYWAY	CENTER 1-2	OPP. KEYWAY 2-3	28 VDC			115 VAC		
T9-MSI-	MS24658-	32	E	NONE	ON	MOM ON	4	15	10	2	15	7
		33	E F K M	NONE	ON	ON	5	20	15	3	15	10

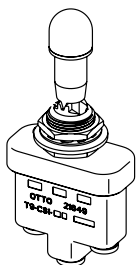

PRODUCT FAMILY TABLE

## Double Pole

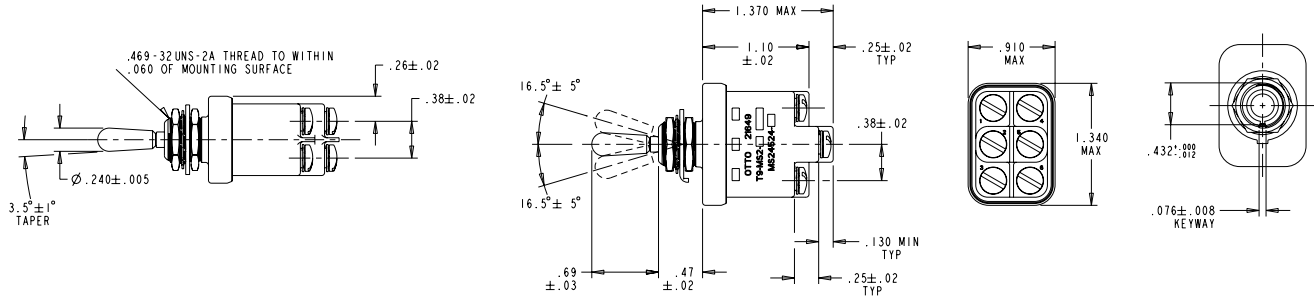

Low level 10mA @ 30mV (commercial version only)

OTTO BASE PART NO.	MILITARY STANDARD	DASH NO.	CIRCUIT CONFIGURATION			ELECTRICAL CURRENT RATINGS (AMPS) - SEA LEVEL & 65,000 FT					
			KEYWAY 1-2 / 4-5	CENTER	OPP. KEYWAY 2-3 / 5-6	28 VDC			115 VAC, 60Hz & 400Hz		
						LAMP	RESISTIVE	INDUCTIVE	LAMP	RESISTIVE	INDUCTIVE
T9-MS2-01	MS27407-	1	ON	2-3 ON 4-5	ON	7	20	15	4	15	15
T9-MS2-02		2	MOM ON	2-3 ON 4-5	ON	5	18	10	2	11	8
T9-MS2-03		3	MOM ON	2-3 ON 4-5	MOM ON	7	20	15	4	15	15
T9-MS2-04		4	ON	1-2 ON 5-6	ON	5	18	10	2	11	8
T9-MS2-05		5	MOM ON	1-2 ON 5-6	ON	7	20	15	4	15	15
T9-MS2-06		6	MOM ON	1-2 ON 5-6	MOM ON	5	18	10	2	11	8
T9-MS2-	MS24524-	21	ON	OFF	ON	7	20	15	4	15	15
		22	OFF	NONE	ON						
		23	ON	NONE	ON						
		24	NONE	OFF	ON						
		25	NONE	MOM OFF	ON	5	18	10	2	11	8
		26	MOM ON	NONE	ON						
		27	MOM ON	OFF	MOM ON						
		28	MOM ON	OFF	NONE						
		29	MOM OFF	NONE	ON						
		30	MOM ON	NONE	OFF						
		31	MOM ON	OFF	ON						
OTTO BASE PART NO.	MILITARY STANDARD	DASH NO.	KEYWAY	CENTER 1-2 / 4-5	OPP. KEYWAY 2-3 / 5-6	28 VDC			115 VAC		
T9-MS2-	MS24524-	32	NONE	ON	MOM ON	5	18	10	2	11	8
		33	NONE	ON	ON	7	20	15	4	15	15

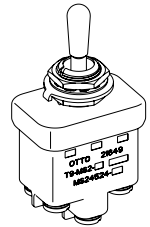

# COMMERCIAL & MIL TOGGLE SWITCHES

## PRODUCT FAMILY TABLE

### Lever/Lock Double Pole

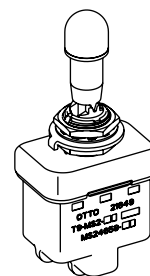
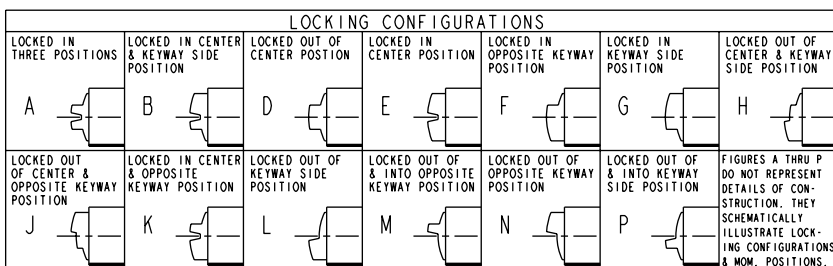
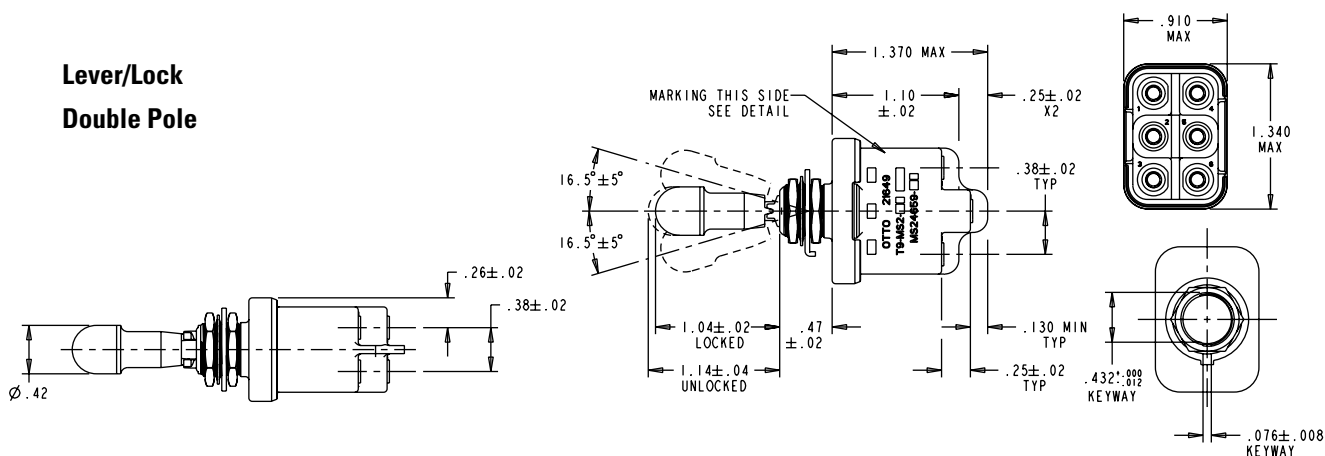

TOGGLE SWITCHES

OTTO BASE PART NO.	MILITARY STANDARD	DASH NO.	AVAILABLE LOCKOUTS (SEE CHART)	CIRCUIT CONFIGURATION			SWITCH POSITION MARKING	ELECTRICAL RATINGS - SEA LEVEL & 65,000 FT							
				KEYWAY 1-2 / 4-5	CENTER	OPP. KEYWAY 2-3 / 5-6		28 VDC			115 VAC, 60Hz & 400Hz				
								LAMP	RESISTIVE	INDUCTIVE	LAMP	RESISTIVE	INDUCTIVE		
T9-MS2-	MS24659-	21	ALL	ON	OFF	ON	ON	OFF	ON	7	20	15	4	15	15
		22	D, F, G	OFF	NONE	ON	ON	OFF	ON						
		23	D, F, G	ON	NONE	ON	ON	ON	ON						
		24	E, F, K, M	NONE	OFF	ON	OFF	ON	ON	5	18	10	2	11	8
		25	F	NONE	MOM OFF	ON	OFF	ON							
		26	F	MOM ON	NONE	ON	ON	ON							
		27	E, L, N	MOM ON	OFF	MOM ON	ON	OFF	ON						
		28	E	MOM ON	OFF	NONE	ON	OFF	ON						
		29	F	MOM OFF	NONE	ON	ON	ON	ON						
		30	F	MOM ON	NONE	OFF	ON	OFF	ON						
31	E, F, K, L, M, N	MOM ON	OFF	ON	ON	OFF	ON								
OTTO BASE PART NO.	MILITARY STANDARD	DASH NO.	AVAILABLE LOCKOUT	KEYWAY	CENTER	OPP. KEYWAY	SWITCH POSITION MARKING	28 VDC			115 VAC				
T9-MS2-	MS24659-	32	E	NONE	ON	MOM ON	ON ON	LAMP	RESISTIVE	INDUCTIVE	LAMP	RESISTIVE	INDUCTIVE		
		33	E, F, K, M	NONE	ON	ON	ON ON	5	18	10	2	11	8		
								7	20	15	4	15	15		