

<b>DIP Sockets</b>	<b>A1 - A25</b>
<b>SIP Sockets</b>	<b>B1 - B7</b>
<b>PLCC/SOJ Sockets</b>	<b>C1 - C9</b>
<b>PGA Sockets</b>	<b>D1 - D51</b>
<b>Pressfit Sockets</b>	<b>E1 - E11</b>
<b>Adapters</b>	<b>F1 - F9</b>
<b>Display Sockets</b>	<b>G1 - G5</b>
<b>Specialty Sockets</b>	<b>H1 - H27</b>
<b>Surface Mount Sockets</b>	<b>I1 - I11</b>
<b>IC Removal Tools</b>	<b>J1 - J4</b>
<b>Indexes/Matrixes</b>	<b>K1 - K8</b>

# TABLE OF CONTENTS

<b>A</b>
<b>B</b>
<b>C</b>
<b>D</b>
<b>E</b>
<b>F</b>
<b>G</b>
<b>H</b>
<b>I</b>
<b>J</b>
<b>K</b>



200SM Series - Page A6



300C Series - Page A8

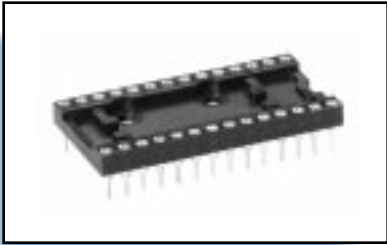

500 Series - Page A10

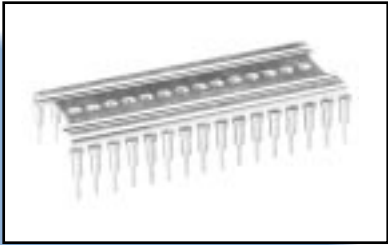

700 Series - Page A12



800 Series - Page A14



800SM Series - Page A16

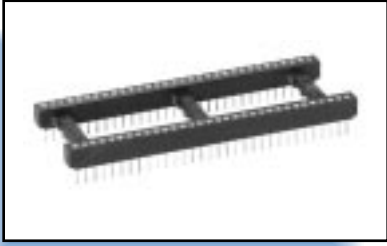

2400 Series - Page A18



DS Series - Page A20

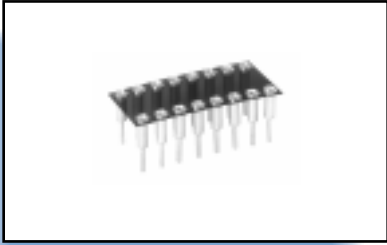

MCK Series - Page A22

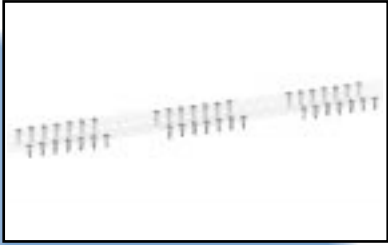

Holtite Series - Page A24

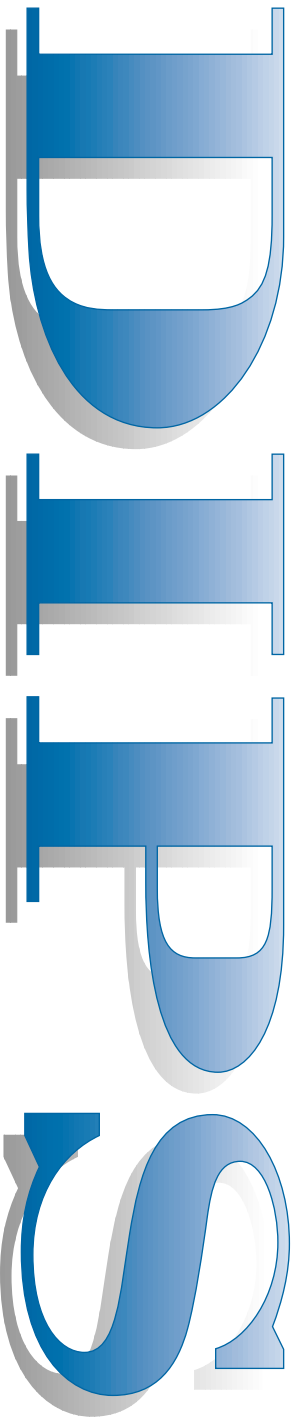

# DIP Product Matrix

## DIP PATTERN

A

Row to Row Spacing	.300"								.400"		
Pin Count	6	8	14	16	18	20	22	24	28	22	24
200C		•	•	•	•	•	•	•	•	•	
200SM		•	•	•	•	•	•	•	•		
300C	•	•	•	•	•	•		•		•	
500	•	•	•	•	•	•				•	•
700	•	•	•	•	•	•	•	•		•	•
800		•	•	•	•	•		•		•	•
800SM		•	•	•	•	•		•		•	•
DS		•	•	•	•	•	•	•	•	•	•
MCK	•	•	•	•	•	•	•	•	•	•	•
Holtites®		•	•	•	•	•				•	•

# DIP Product Matrix

DIP PATTERN



.600"								.900"				Row to Row Spacing
24	28	32	36	40	42	48	52	32	50	52	64	Pin Count
•	•	•		•	•	•						200C
•	•	•		•		•						200SM
•	•	•		•	•							300
•	•	•	•	•								500
•	•	•	•	•								700
•	•	•	•	•	•	•					•	800
•	•	•	•	•	•	•					•	800SM
•	•	•		•		•						DS
•	•	•	•	•	•	•	•	•	•	•	•	MCK
•	•	•	•	•	•							Holtites®

**Need more technical information?**  
 Consult your Thomas & Betts  
 sales office listed on the back cover

# 200C Series *Stamped Single Beam Contact Closed Bottom DIP Sockets*

A



216-AG19DC

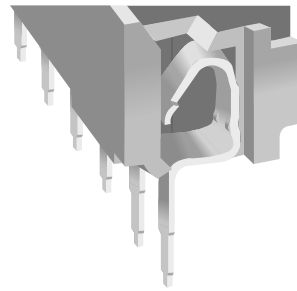

## FEATURES:

The Augat 200C Series single beam side wipe contact provides maximum normal force and consistent mechanical performance in Augat's lowest cost socket.

- Non-wicking, closed bottom design gives protection against flux and solder contamination
- Protected open entry for easy insertion of IC's by hand or by automatic insertion
- Anti-overstress design protects contacts, helps eliminate damage from oversize leads and maintains consistent normal force
- High normal force results in gas tight connections
-  Recognized under the Component Program of Underwriters Laboratories, Inc. File No. E111362

## APPLICATION DIMENSIONS:

- PWB Thickness Range: Standard .062" and .092" (1,57 and 2,34)
- PWB Hole Size Range: .055" ± .002" (1,40 ± 0,05)
- IC Pin Dimension Range: .008" x .015" ( 0,20 x 0,38) through .015" x .023" (0,38 x 0,58), .115" (2,92) min. length

## MATERIAL SPECIFICATIONS:

Insulator ..... Thermoplastic polyester, UL rated 94V-0  
Contacts ..... Phosphor bronze or beryllium copper  
Plating ..... Tin/lead

## PERFORMANCE SPECIFICATIONS:

### MECHANICAL

Vibration ..... Passed MIL-STD-1344, Method 2005.1,  
Condition III, 15 G's  
Shock ..... Passed MIL-STD-1344, Method 2004.1,  
Condition G, 100 G's  
Durability ..... Passed MIL-STD-1344, Method 2016, 50 cycles  
Normal Force ..... 170 Grams (6.0 oz.) with .009" x .015"  
(0,23 x 0,38) IC lead typ.  
Contact Retention ..... 340 Grams (12.0 oz.) minimum  
Solderability ..... Passed MIL-STD-202, Method 208  
Insertion Force ..... 169 Grams (6.0 oz.) average with a .013" x .020"  
(0,33 x 0,51) dia. polished steel pin  
Withdrawal Force ..... 43 Grams (1.5 oz.) average with a .009" x .015"  
(0,23 x 0,38) dia. polished steel pin

### ELECTRICAL

Contact Resistance ..... 10 Milliohms  
Contact Rating ..... 2 Amps  
Capacitance ..... .5 pF per MIL-STD-202, Method 305  
(Adjacent contacts max.)  
Insulation Resistance .... 2 x 10<sup>6</sup> Megohms per MIL-STD-1344,  
Method 3003.1  
Dielectric Withstanding  
Voltage ..... 1,000 Volts RMS per MIL-STD-1344,  
Method 3001

### ENVIRONMENTAL

Humidity ..... Passed MIL-STD-1344, Method 1002.2  
Thermal Shock ..... Passed MIL-STD-1344, Method 1003.1  
Temperature Cycling .... Passed MIL-STD-1344, Method 1003.1  
Operation Temperature .. Gold -55°C to +125°C  
Tin -55°C to +105°C  
Salt Spray ..... Passed MIL-STD-1344, Method 1001.1

# Stamped Single Beam Contact Closed Bottom DIP Sockets 200C Series

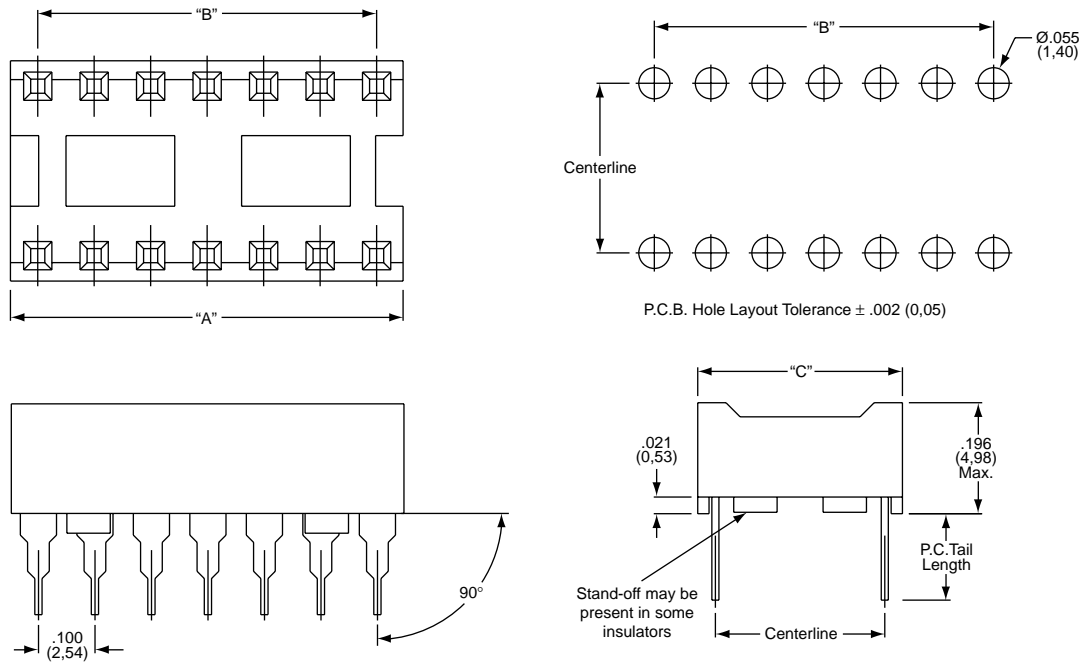

## STANDARD CONFIGURATIONS

Number of Contacts	A	B	C	Number of Contacts	A	B	C
8	.400 (10,16)	.300 (7,62)	.400 (10,16)	24	1.200 (30,48)	1.100 (27,94)	.700 (17,78)
14	.700 (17,78)	.600 (15,24)		28	1.400 (35,56)	1.300 (33,02)	.400 (10,16)
16	.800 (20,32)	.700 (17,78)		28	1.400 (35,56)	1.300 (33,02)	.700 (17,78)
18	.900 (22,86)	.800 (20,32)		32	1.600 (40,64)	1.500 (38,10)	
20	1.000 (25,40)	.900 (22,86)		40	2.000 (50,80)	1.900 (48,26)	
22	1.100 (27,94)	1.000 (25,40)		42	2.100 (53,34)	2.000 (50,80)	
24	1.200 (30,48)	1.100 (27,94)		48	2.400 (60,96)	2.300 (58,42)	

## PART NUMBERS

Part Number	Position	Centerline	Contact Material	Part Number	Position	Centerline	Contact Material
208-AG19DC	8	.300	Phos. Bronze	224-AG19DC	24	.600	Phos. Bronze
208-AG39DC	8	(7,62)	Beryllium Copper	224-AG39DC	24	(15,24)	Beryllium Copper
214-AG19DC	14	.300	Phos. Bronze	228-AG10DC	28	.300	Phos. Bronze
214-AG39DC	14	(7,62)	Beryllium Copper	228-AG30DC	28	(7,62)	Beryllium Copper
216-AG19DC	16	.300	Phos. Bronze	228-AG19DC	28	.600	Phos. Bronze
216-AG39DC	16	(7,62)	Beryllium Copper	228-AG39DC	28	(15,24)	Beryllium Copper
218-AG19DC	18	.300	Phos. Bronze	232-AG19DC	32	.600	Phos. Bronze
218-AG39DC	18	(7,62)	Beryllium Copper	232-AG39DC	32	(15,24)	Beryllium Copper
220-AG19DC	20	.300	Phos. Bronze	236-AG19DC	36	.600	Phos. Bronze
220-AG39DC	20	(7,62)	Beryllium Copper	236-AG39DC	36	(15,24)	Beryllium Copper
222-AG10DC	22	.300	Phos. Bronze	242-AG10DC	42	.600	Phos. Bronze
222-AG30DC	22	(7,62)	Beryllium Copper	242-AG30DC	42	(15,24)	Beryllium Copper
224-AG10DC	24	.300	Phos. Bronze	248-AG10DC	48	.600	Phos. Bronze
224-AG30DC	24	(7,62)	Beryllium Copper	248-AG30DC	48	(15,24)	Beryllium Copper

Note: Part Numbers in this chart refer to a .125" PC Tail Pin

### Need more technical information?

Consult your Thomas & Betts sales office listed on the back cover

# 200SM Series *Surface Mount DIP Sockets*

A



228-AG19SM

## FEATURES:

Augat offers two styles of surface mount sockets: The stamped single beam 200SM Series and the precision machined 800SM Series. Both series achieve compliancy to the board surface and are designed for high temperatures typical of vapor phase and infrared reflow soldering.

- "L" bent lead design achieves high compliancy to board surface
- Single beam contact provides gas tight connection
- Enlarged vacuum pick and place surface area

## APPLICATION DIMENSIONS:

- IC Pin Dimension Range: .008" x .015" ( 0,20 x 0,38) through .015" x .020" (0,38 x 0,51), .115" (2,92) min. length

## MATERIAL SPECIFICATIONS:

Insulator ..... Thermoplastic polyester, UL rated 94V-0  
Contacts ..... Phosphor bronze or beryllium copper  
Plating ..... Tin/lead

## PERFORMANCE SPECIFICATIONS:

### MECHANICAL

Vibration ..... Passed MIL-STD-202, Method 204  
Durability ..... Passed MIL-STD-1344, Method 2016, 50 cycles min.  
Normal Force ..... 320 Grams (11.3 oz.) with .008" x .015" (0,20 x 0,38) IC lead (typ.)  
Contact Retention  
in Plastic ..... 400 Grams (14.1 oz.) minimum  
Solderability ..... Passed MIL-STD-202, Method 208  
Insertion Force ..... 305 Grams (10.8 oz.) average with a .013" x .020" (0,33 x 0,51) dia. polished steel pin  
Withdrawal Force ..... 113 Grams (10.8 oz.) average with a .008" x .015" (0,20 x 0,38) dia. polished steel pin

### ELECTRICAL

Contact Resistance ..... 10 Milliohms max.  
Contact Rating ..... 2 Amps  
Capacitance ..... .2 pF per MIL-STD-202, Method 305 (contact to contact)  
Insulation Resistance .... 3 x 10<sup>4</sup> Megohms per MIL-STD-1344, Method 3003.1  
Dielectric Withstanding Voltage ..... 1,000 Volts RMS per MIL-STD-1344, Method 3001

### ENVIRONMENTAL

Humidity ..... Passed MIL-STD-1344, Method 1002.2  
Thermal Shock ..... Passed MIL-STD-1344, Method 1003.1,  
Operation Temperature .. Gold -55°C to +125°C  
Tin -55°C to +105°C  
Salt Spray ..... Passed MIL-STD-1344, Method 1001.1

# Surface Mount DIP Sockets 200SM Series

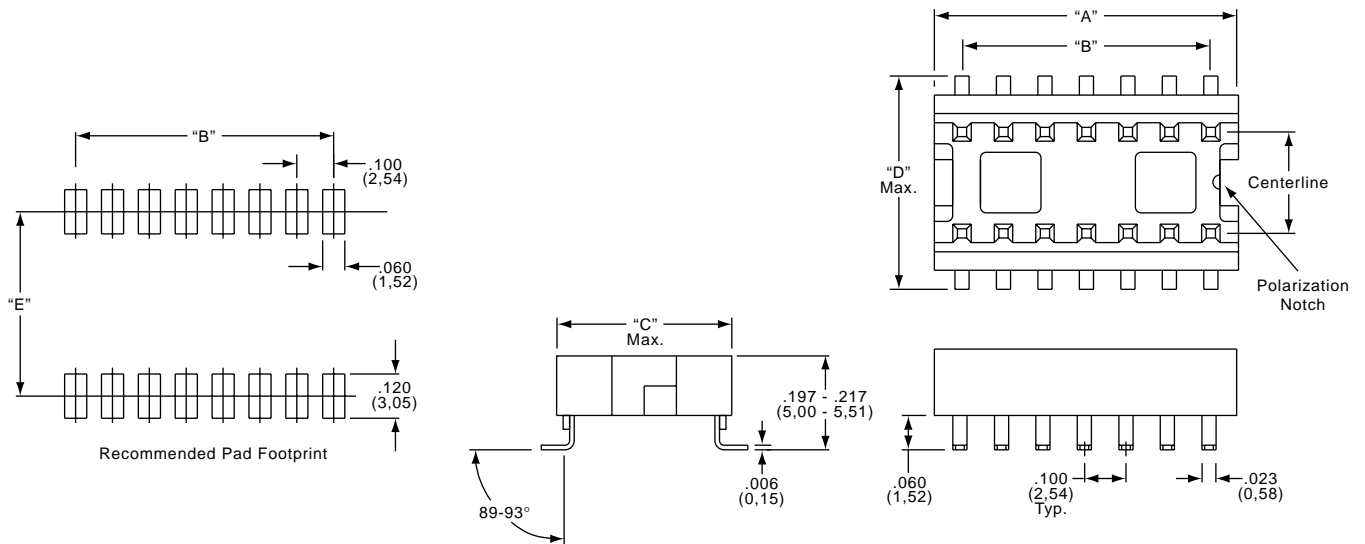

## STANDARD CONFIGURATIONS

Number of Contacts	A	B	C	D	E
28	1.400 (35,56)	1.300 (33,02)	.700 (17,78)	.715 (18,16)	.660 (16,76)
32	1.600 (40,64)	1.500 (38,10)			

## PART NUMBERS

Part Number	Position	Centerline	Contact Material
228-AG19DC	28	.600	Phosphor Bronze
228-AG39DC	28	(15,24)	Beryllium Copper
232-AG19DC	32	.600	Phosphor Bronze
232-AG39DC	32	(15,24)	Beryllium Copper

Consult factory for 24 position, .600 centerline availability

### Need more technical information?

Consult your Thomas & Betts sales office listed on the back cover



# 300C Series *Stamped Dual Wipe Contact DIP Sockets*

A

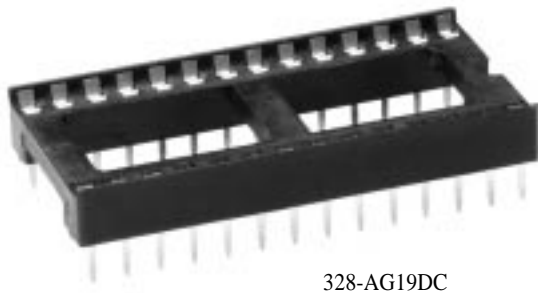

328-AG19DC

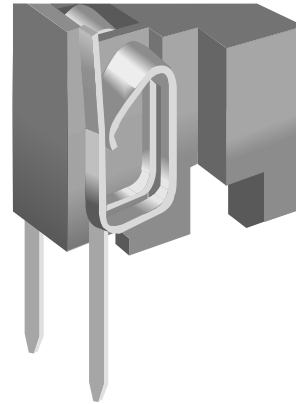

## FEATURES:

The Augat 300C Series dual wipe contact adds a new family of product to Augat's low cost DIP socket line.

- Closed bottom prevents solder wicking
- Standoff's facilitate board cleaning
- Low profile design
-  Recognized under the Component Program of Underwriters Laboratories, Inc. File No. E111362

## APPLICATION DIMENSIONS:

- PCB Thickness Range: Standard .062" and .092" (1,57 and 2,34)
- PCB Hole Size Range: .035" ± .003" (0,89 ± 0,08) standard tail
- IC Pin Dimension Range: .008" x .015" ( 0,20 x 0,38) through .013" x .020" (0,33 x 0,51), .100" (2,54) min. length

## MATERIAL SPECIFICATIONS:

Insulator ..... Thermoplastic polyester, UL rated 94V-0  
 Contacts ..... Phosphor bronze  
 Plating ..... Tin/lead

## PERFORMANCE SPECIFICATIONS:

### MECHANICAL

Vibration ..... Passed MIL-STD-1344, Method 2005.1, Condition III, 15 G's  
 Shock ..... Passed MIL-STD-1344, Method 2004.1, Condition G, 100 G's  
 Durability ..... Passed MIL-STD-1344, Method 2016  
 Normal Force ..... 170 Grams (6.0 oz.) with .009" x .015" (0,23 x 0,38) IC lead typ.  
 Contact Retention ..... 340 Grams (12.0 oz.) minimum  
 Solderability ..... Passed MIL-STD-202, Method 208  
 Insertion Force ..... 169 Grams (6.0 oz.) average with a .013" x .020" (0,33 x 0,51) dia. polished steel pin  
 Withdrawal Force ..... 43 Grams (1.5 oz.) average with a .009" x .015" (0,23 x 0,38) dia. polished steel pin

### ELECTRICAL

Contact Resistance ..... 10 Milliohms  
 Contact Rating ..... 2 Amps  
 Capacitance ..... .5 pF per MIL-STD-202, Method 305 (Adjacent contacts max.)  
 Insulation Resistance .... 5,000 Megohms @ 500 VDC per MIL-STD-1344, Method 3003.1  
 Dielectric Withstanding  
 Voltage ..... 1,000 Volts RMS per MIL-STD-1344, Method 3001

### ENVIRONMENTAL

Humidity ..... Passed MIL-STD-1344, Method 1002.2  
 Thermal Shock ..... Passed MIL-STD-1344, Method 1003.1  
 Temperature Cycling .... Passed MIL-STD-1344, Method 1003.1  
 Operation Temperature .. Gold -55°C to +125°C  
 Tin -55°C to +105°C  
 Salt Spray ..... Passed MIL-STD-1344, Method 1001.1

# Stamped Dual Wipe Contact DIP Sockets 300C Series

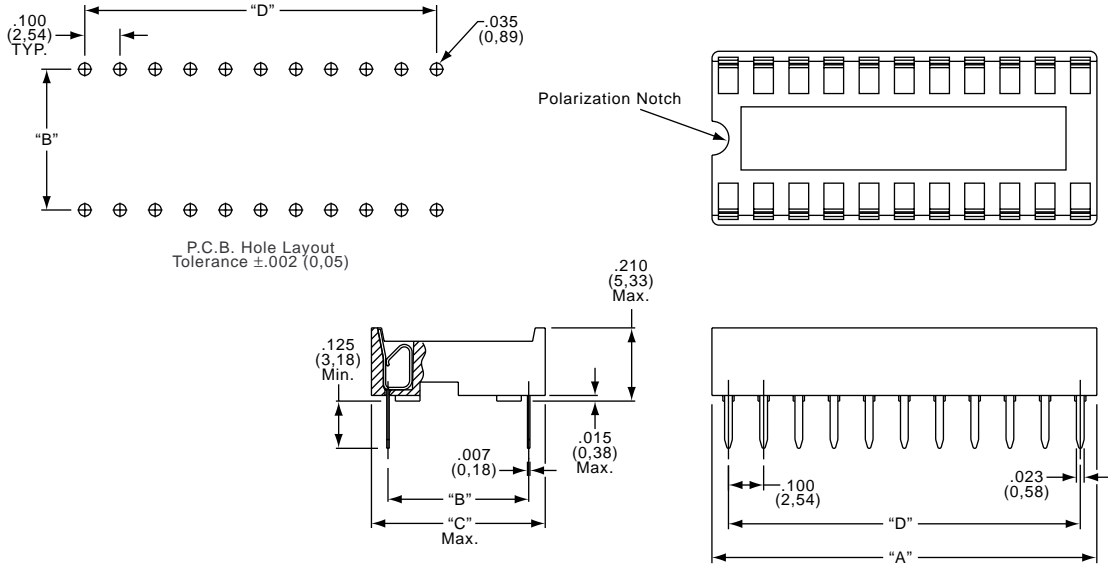

## STANDARD CONFIGURATIONS/PART NUMBERS

Part Number	Number of Contacts	A	B*	C	D	Part Number	Number of Contacts	A	B*	C	D
306-AG19DC *	6	.300 (7,62)	.300 ± .005 (7,62 ± 0,13)	.400 (10,16)	.200 (5,08)	324-AG19DC	24	1.200 (30,48)	.600 ± .005 (15,24 ± 0,13)	.700 (17,78)	1.100 (27,94)
308-AG19DC *	8	.400 (10,16)			.300 (7,62)	324-1G7 *	24	1.200 (30,48)			1.100 (27,94)
314-AG19DC *	14	.700 (17,78)			.600 (15,24)	328-AG19DC	28	1.400 (35,56)			1.300 (33,02)
316-AG19DC *	16	.800 (20,32)			.700 (17,78)	328-1G7 *	28	1.400 (35,56)			1.300 (33,02)
318-AG19DC *	18	.900 (22,86)			.800 (20,32)	332-AG19DC	32	1.600 (40,64)			1.500 (38,10)
320-AG19DC *	20	1.000 (25,40)			.900 (22,86)	332-1G7 *	32	1.600 (40,64)			1.500 (38,10)
324-AG10DC *	24	1.200 (30,48)			1.100 (27,94)	340-AG19DC	40	2.000 (50,80)			1.900 (48,26)
328-AG10DC	28	1.400 (35,56)			1.300 (33,02)	340-1G7 *	40	2.000 (50,80)			1.900 (48,26)
328-10G7 *	28	1.400 (35,56)			1.300 (33,02)	342-AG19DC	42	2.100 (53,34)			2.000 (50,80)
332-AG10DC	32	1.600 (40,64)			1.500 (38,10)						

\* Denotes Open Frame Design

Part Number	Number of Contacts	A	B*	C	D
322-AG19DC	22	1.100 (27,94)	.400 ± .005 (10,16 ± 0,13)	.500 (12,70)	1.000 (25,40)

Open Frame

Ladder



328-10G7



328-AG10DC

Need more technical information?

Consult your Thomas & Betts sales office listed on the back cover

# 500 Series *DIP Socket with Four-Fingered Contact & Solid Insulator*

A

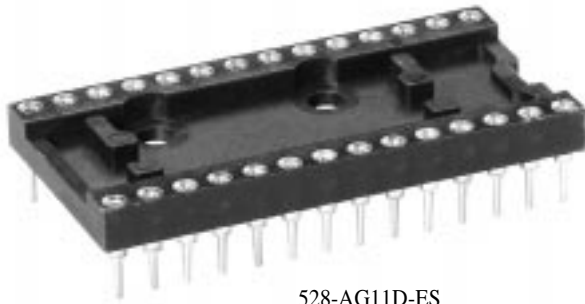

528-AG11D-ES

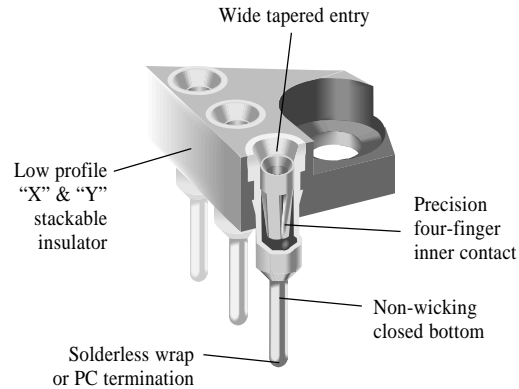

## FEATURES:

The Augat 500 Series Socket features a precision four-finger inner contact to produce the industry standard for high reliability screw machine sockets.

- Precision four-finger inner contact provides concentric funnel entry for easy flat and round lead insertion
- Machined (Premium Series) and stamped (Economy Series) contacts are available
- "X" & "Y" stackable
- Non-wicking, closed bottom sleeve gives 100% protection against flux and solder contamination. Choice of solderless wrap or PC termination
- Accommodates 6 through 40 pin DIPS, rectangular or round leads
- Recognized under the Component Program of Underwriters Laboratories, Inc. file no. E111362
- Beryllium copper inner contact for maximum mechanical and electrical performance
- For extreme conditions involving shock and vibration, Augat's high retention series is available

## APPLICATION DIMENSIONS:

- PCB Thickness Range: Standard .062" and .092" (1,57 and 2,34)
- PCB Hole Size Range: .035" ± .002" (0,89 ± 0,05) PC tail, .055" ± .003" (1,40 ± 0,08) solderless wrap
- IC Pin Dimension Range: .009" x .015" (0,23 x 0,38) through .011" x .020" (0,28 x 0,51)  
.016" to .021" (0,41 to 0,53) round lead, .105" (2,67) min. length

## MATERIAL SPECIFICATIONS:

Insulator ..... Thermoplastic polyester, UL rated 94V-0  
Sleeve ..... Machined brass/formed copper  
Contact ..... Beryllium copper  
Sleeve Plating ..... Tin/lead or gold  
Contact Plating ..... Premium or Economy Series (ES) - gold or tin/lead  
Economy Series (ESL) - low gold  
Vapor Phase/IR Compatible

## PERFORMANCE SPECIFICATIONS:

### MECHANICAL

Vibration ..... Passed MIL-STD-1344, Method 2005.1, Condition II, 10 G's  
Shock ..... Passed MIL-STD-1344, Method 2004.1, Condition C, 100 G's  
Durability ..... Passed MIL-STD-1344, Method 2016  
Normal Force ..... 125 Grams (4.4 oz.) average with .018" (0,46) dia. polished steel pin (Premium Series)  
200 Grams (7.1 oz.) average with .018" (0,46) dia. polished steel pin (Economy Series)  
Inner Contact Retention  
in Sleeve ..... 7.5 Lbs. per line average  
Sleeve Retention  
in Plastic ..... 3.0 Lbs. per line minimum  
Solderability ..... Passed MIL-STD-202F, Method 208  
Insertion Force ..... Premium - 134 Grams (4.7 oz.) average with a .018" (0,46) dia. polished steel pin  
Economy - 179 Grams (6.3 oz.) average with a .018" (0,46) dia. polished steel pin  
Withdrawal Force ..... 63 Grams (2.2 oz.) average with a .018" (0,46) (Premium and Economy) dia. polished steel pin

### ELECTRICAL

Contact Resistance ..... 10 Milliohms max.  
Contact Rating ..... 3 Amps  
Capacitance ..... 1.0 pF per MIL-STD-202, Method 305 (contact to contact)  
Insulation Resistance .... 5,000 Megohms min. @ 500 VDC per MIL-STD-1344, Method 3003.1  
Dielectric Withstanding  
Voltage ..... 1,000 Volts RMS per MIL-STD-1344, Method 3001.1

### ENVIRONMENTAL

Humidity ..... Passed MIL-STD-1344, Method 1002.2, Cond. II  
Thermal Shock ..... Passed MIL-STD-1344, Method 1003.1, Cond. A  
Operation Temperature .. Gold inner contact -55°C to +125°C,  
Tin/lead inner contact -55°C to +105°C

**Thomas & Betts**

Quality & Innovation From The **AUGAT**® Product Group

A10

Thomas & Betts  
1555 Lynnfield Road  
Memphis, TN 38119  
(901) 682-8221 FAX (901) 537-8805

# DIP Socket with Four-Fingered Contact & Solid Insulator 500 Series

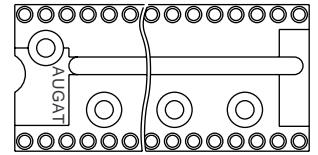

Figure 2

## STANDARD CONFIGURATIONS

Number of Contacts	A	B*	C	Number of Contacts	A	B*	C
6	.300 (7,62)	.300 (7,62)	.400 (10,16)	24	1.200 (30,48)	.400 (10,16)	.500 (12,70)
8	.400 (10,16)			24	1.200 (30,48)		
14	.700 (17,78)			28	1.400 (35,56)		
16	.800 (20,32)			32	1.600 (40,64)	.600 (15,24)	.700 (45,72)
18	.900 (22,86)			36	1.800 (47,72)		
20	1.000 (25,40)			40	2.000 (50,80)		
22	1.150 (29,21)	.400 (10,16)	.500 (12,70)				

\* Dimension B ± .005 (0,13)

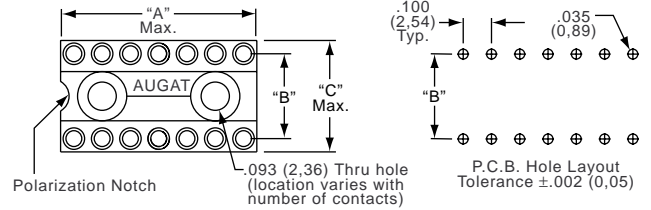
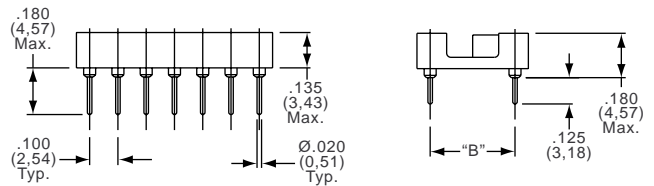

Figure 1



## PART NUMBERS

Economy Series	Premium	Figure	Position	Centerline	Contact	Sleeve	Economy Series	Premium	Figure	Position	Centerline	Contact	Sleeve
506-AG10D-ES	506-AG10D	1	6	.300 (7,62)	Gold	Gold	524-AG65D-ES	524-AG65D	2	24	.400 (10,16)	Gold	Gold
506-AG10D-ESL			6		Low Gold	Gold	524-AG65D-ESL			24		Low Gold	Gold
506-AG11D-ES	506-AG11D		6		Gold	Tin/Lead	524-AG66D-ES	524-AG66D		24		Gold	Tin/Lead
506-AG11D-ESL			6		Low Gold	Tin/Lead	524-AG66D-ESL			24		Low Gold	Tin/Lead
506-AG12D-ES	506-AG12D		6		Tin/Lead	Tin/Lead	524-AG13D-ES	524-AG13D		24		Tin/Lead	Tin/Lead
508-AG10D-ES	508-AG10D	1	8	.300 (7,62)	Gold	Gold	524-AG10D-ES	524-AG10D	2	24	.600 (15,24)	Gold	Gold
508-AG10D-ESL			8		Low Gold	Gold	524-AG10D-ESL			24		Low Gold	Gold
508-AG11D-ES	508-AG11D		8		Gold	Tin/Lead	524-AG11D-ES	524-AG11D		24		Gold	Tin/Lead
508-AG11D-ESL			8		Low Gold	Tin/Lead	524-AG11D-ESL			24		Low Gold	Tin/Lead
508-AG12D-ES	508-AG12D		8		Tin/Lead	Tin/Lead	524-AG12D-ES	524-AG12D		24		Tin/Lead	Tin/Lead
514-AG10D-ES	514-AG10D	1	14	.300 (7,62)	Gold	Gold	528-AG10D-ES	528-AG10D	2	28	.600 (15,24)	Gold	Gold
514-AG10D-ESL			14		Low Gold	Gold	528-AG10D-ESL			28		Low Gold	Gold
514-AG11D-ES	514-AG11D		14		Gold	Tin/Lead	528-AG11D-ES	528-AG11D		28		Gold	Tin/Lead
514-AG11D-ESL			14		Low Gold	Tin/Lead	528-AG11D-ESL			28		Low Gold	Tin/Lead
514-AG12D-ES	514-AG12D		14		Tin/Lead	Tin/Lead	528-AG12D-ES	528-AG12D		28		Tin/Lead	Tin/Lead
516-AG10D-ES	516-AG10D	1	16	.300 (7,62)	Gold	Gold	532-AG10D-ES	532-AG10D	2	32	.600 (15,24)	Gold	Gold
516-AG10D-ESL			16		Low Gold	Gold	532-AG10D-ESL			32		Low Gold	Gold
516-AG11D-ES	516-AG11D		16		Gold	Tin/Lead	532-AG11D-ES	532-AG11D		32		Gold	Tin/Lead
516-AG11D-ESL			16		Low Gold	Tin/Lead	532-AG11D-ESL			32		Low Gold	Tin/Lead
516-AG12D-ES	516-AG12D		16		Tin/Lead	Tin/Lead	532-AG12D-ES	532-AG12D		32		Tin/Lead	Tin/Lead
518-AG10D-ES	518-AG10D	1	18	.300 (7,62)	Gold	Gold	536-AG10D-ES	536-AG10D	2	36	.600 (15,24)	Gold	Gold
518-AG10D-ESL			18		Low Gold	Gold	536-AG10D-ESL			36		Low Gold	Gold
518-AG11D-ES	518-AG11D		18		Gold	Tin/Lead	536-AG11D-ES	536-AG11D		36		Gold	Tin/Lead
518-AG11D-ESL			18		Low Gold	Tin/Lead	536-AG11D-ESL			36		Low Gold	Tin/Lead
518-AG12D-ES	518-AG12D		18		Tin/Lead	Tin/Lead	536-AG12D-ES	536-AG12D		36		Tin/Lead	Tin/Lead
520-AG10D-ES	520-AG10D	1	20	.300 (7,62)	Gold	Gold	540-AG10D-ES	540-AG10D	2	40	.600 (15,24)	Gold	Gold
520-AG10D-ESL			20		Low Gold	Gold	540-AG10D-ESL			40		Low Gold	Gold
520-AG11D-ES	520-AG11D		20		Gold	Tin/Lead	540-AG11D-ES	540-AG11D		40		Gold	Tin/Lead
520-AG11D-ESL			20		Low Gold	Tin/Lead	540-AG11D-ESL			40		Low Gold	Tin/Lead
520-AG12D-ES	520-AG12D		20		Tin/Lead	Tin/Lead	540-AG12D-ES	540-AG12D		40		Tin/Lead	Tin/Lead
522-AG10D-ES	522-AG10D	1	22	.400 (10,16)	Gold	Gold	Note: Part numbers in this chart and in detail shown refer to a .125" PC Tail Pin						
522-AG10D-ESL			22		Low Gold	Gold							
522-AG11D-ES	522-AG11D		22		Gold	Tin/Lead							
522-AG11D-ESL			22		Low Gold	Tin/Lead							
522-AG12D-ES	522-AG12D		22		Tin/Lead	Tin/Lead							

## ECONOMY AND PREMIUM SERIES - .180" PC TAIL PINS

- 5XX-AG44D-XXX - Gold contact, tin/lead sleeve
- 5XX-AG45D-XXX - Gold contact, gold sleeve
- 5XX-AG143D-XXX - Tin/lead contact, tin/lead sleeve

## HIGH RETENTION SERIES

- 5XX-AG34D - Gold contact, tin/lead sleeve
- 5XX-AG33D - Gold contact, gold sleeve
- 5XX-AG138D - Tin/lead contact, tin/lead sleeve

For wire wrap sockets or 24 position on .400" (10,16) in high retention or .180 (4,57) tails, please consult factory.

## Need more technical information?

Consult your Thomas & Betts sales office listed on the back cover

# 700 Series *Four-Fingered Contacts Disposable Carriers*

A



732-AG4D-ES

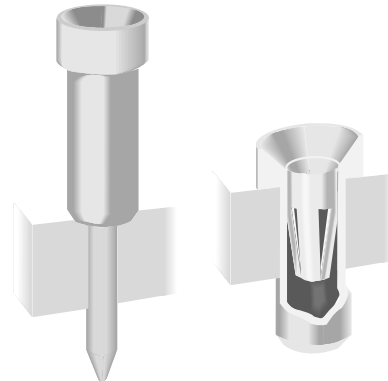

## FEATURES:

A disposable aluminum carrier forms the backbone of the 700 Series socket, an innovative extension of the Augat precision four-fingered, inner contact concept. Conceived for IC applications requiring maximum air flow for cooling, the 700 Series eliminates heat entrapment associated with an insulator. Additional benefits are:

- Easy solder joint inspection-easy cleaning-easy repair
- “X” & “Y” stackability for circuit flexibility and optimum use of PCB real estate
- Gang insertion of socket pins into PC boards
- 100% non-wicking of flux and solder
- Standard or low profile PC board mounting
- Availability in 6 to 40 positions on .100" (2,54) centers and a wide variety of row spacing
- Machined (Premium Series) and stamped (Economy Series) contacts are available

## APPLICATION DIMENSIONS:

- PCB Thickness Range: Standard .062" and .092" (1,57 and 2,34)
- IC Pin Dimension Range: .016" to .021" (0,41 to 0,53) dia., .105" (2,67) min. length
- PCB Hole Size Range: .035" ± .003" (0,89 ± 0,08) standard mount, .055 ± .001" (1,40 ± 0,03) low profile mount

## MATERIAL SPECIFICATIONS:

Carrier .....	Aluminum
Sleeve .....	Machined brass
Contact .....	Beryllium copper
Sleeve Plating .....	Tin/lead or gold
Contact Plating .....	Premium or Economy Series (ES) - gold or tin/lead Economy Series (ESL) - low gold

## PERFORMANCE SPECIFICATIONS:

### MECHANICAL

Vibration .....	Passed MIL-STD-1344, Method 2005.1, Condition II, 10 G's
Shock .....	Passed MIL-STD-1344, Method 2004.1, Condition C, 100 G's
Durability .....	Passed MIL-STD-1344, Method 2016
Normal Force .....	125 Grams average with .018" (0,46) dia. polished steel pin (Premium Series) 200 Grams average with .018" (0,46) dia. polished steel pin (Economy Series)
Inner Contact Retention in Sleeve .....	7.5 Lbs. per line average
Sleeve Retention in Plastic .....	3.0 Lbs. per line minimum
Solderability .....	Passed MIL-STD-202F, Method 208
Insertion Force .....	Premium - 134 Grams (4.7 oz.) average with a .018" (0,46) dia. polished steel pin Economy - 179 Grams (6.3 oz.) average with a .018" (0,46) dia. polished steel pin
Withdrawal Force .....	63 Grams (2.2 oz.) average with a (Premium and Economy) .018" (0,46) dia. polished steel pin

### ELECTRICAL

Contact Resistance .....	10 Milliohms max.
Contact Rating .....	3 Amps
Capacitance .....	1.0 pF per MIL-STD-202, Method 305 (contact to contact)
Insulation Resistance ....	5,000 Megohms min. @ 500 VDC per MIL-STD-1344, Method 3003.1
Dielectric Withstanding Voltage .....	1,000 Volts RMS per MIL-STD-1344, Method 3001.1

### ENVIRONMENTAL

Humidity .....	Passed MIL-STD-1344, Method 1002.2, Cond. II
Thermal Shock .....	Passed MIL-STD-1344, Method 1003.1, Cond. A
Operation Temperature ..	Gold inner contact -55°C to +125°C, Tin/lead inner contact -55°C to +105°C

**Thomas & Betts**

Quality & Innovation From The **AUGAT**® Product Group

A12

Thomas & Betts  
1555 Lynnfield Road  
Memphis, TN 38119  
(901) 682-8221 FAX (901) 537-8805

# Four-Fingered Contacts Disposable Carriers 700 Series

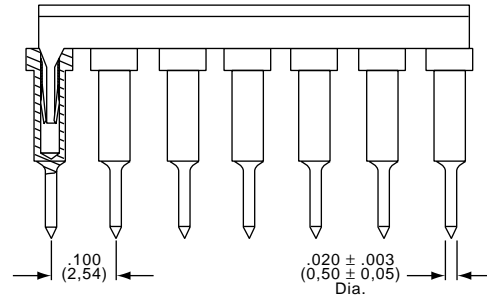
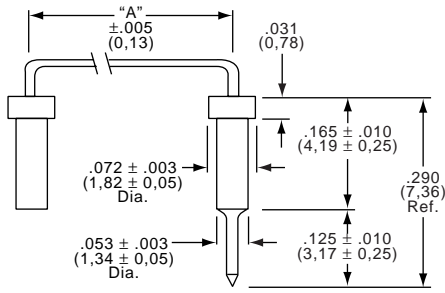

## MOUNTING OPTIONS

## REPLACEMENT SOCKET TERMINALS

	Standard Mount	Low Profile Mount
Gold Sleeve	LSG-1AG14-1	LSG-1DG17-1
Tin/Lead Sleeve	LSG-1AG14-14	LSG-1DG17-14

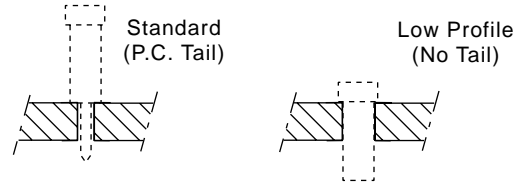

## STANDARD MOUNT PART NUMBERS

Economy Series Part Number	Premium Series Part Number	Number of Contacts	Contact Plating	Sleeve Plating	A	Economy Series Part Number	Premium Series Part Number	Number of Contacts	Contact Plating	Sleeve Plating	A
706-AG2D-ES	706-AG2D	6	Gold	Gold	.300 (7,62)	724-AG2D-ES	724-AG2D	24	Gold	Gold	.300 (7,62)
706-AG2D-ESL	706-AG2D	6	Low Gold	Tin/Lead		724-AG2D-ESL	724-AG2D	24	Low Gold	Tin/Lead	
708-AG2D-ES	708-AG2D	8	Gold	Gold		724-AG22D-ES	724-AG22D	24	Gold	Gold	
708-AG2D-ESL	708-AG2D	8	Low Gold	Tin/Lead	.400 (10,16)	724-AG22D-ESL	724-AG22D	24	Low Gold	Tin/Lead	.400 (10,16)
714-AG2D-ES	714-AG2D	14	Gold	Gold		724-AG3D	724-AG3D	24	Gold	Gold	
714-AG2D-ESL	714-AG2D	14	Low Gold	Tin/Lead		724-AG4D-ES	724-AG4D	24	Gold	Tin/Lead	
716-AG2D-ES	716-AG2D	16	Gold	Gold	.600 (15,24)	724-AG4D-ESL	724-AG4D	24	Low Gold	Tin/Lead	.600 (15,24)
716-AG2D-ESL	716-AG2D	16	Low Gold	Tin/Lead		728-AG3D	728-AG3D	28	Gold	Gold	
718-AG2D-ES	718-AG2D	18	Gold	Gold		728-AG4D-ES	728-AG4D	28	Gold	Tin/Lead	
718-AG2D-ESL	718-AG2D	18	Low Gold	Tin/Lead	.300 (7,62)	728-AG4D-ESL	728-AG4D	28	Low Gold	Tin/Lead	.300 (7,62)
720-AG2D-ES	720-AG2D	20	Gold	Gold		732-AG3D	732-AG3D	32	Gold	Gold	
720-AG2D-ESL	720-AG2D	20	Low Gold	Tin/Lead		732-AG4D-ES	732-AG4D	32	Gold	Tin/Lead	
722-AG2D-ES	722-AG2D	22	Gold	Gold	.400 (10,16)	732-AG4D-ESL	732-AG4D	32	Low Gold	Tin/Lead	.400 (10,16)
722-AG2D-ESL	722-AG2D	22	Low Gold	Tin/Lead		736-AG3D	736-AG3D	36	Gold	Gold	
722-AG2D-ESL	722-AG2D	22	Low Gold	Tin/Lead		736-AG4D-ES	736-AG4D	36	Gold	Tin/Lead	
722-AG2D-ESL	722-AG2D	22	Low Gold	Tin/Lead	.300 (7,62)	736-AG4D-ESL	736-AG4D	36	Low Gold	Tin/Lead	.300 (7,62)
722-AG22D-ES	722-AG22D	22	Gold	Gold		740-AG3D	740-AG3D	40	Gold	Gold	
722-AG22D-ESL	722-AG22D	22	Low Gold	Tin/Lead		740-AG4D-ES	740-AG4D	40	Gold	Tin/Lead	
722-AG22D-ESL	722-AG22D	22	Low Gold	Tin/Lead				Low Gold	Tin/Lead		

## LOW PROFILE PART NUMBERS

Low Profile Part Number	Number of Contacts	Outer Sleeve Plating	A	Low Profile Part Number	Number of Contacts	Outer Sleeve Plating	A
706-AG10D	6	Gold	.300 (7,62)	724-AG10D	24	Gold	.300 (7,62)
706-AG20D	6	Tin/Lead		724-AG20D	24	Tin/Lead	
708-AG10D	8	Gold		724-AG410D	24	Gold	
708-AG20D	8	Tin/Lead	.400 (10,16)	724-AG420D	24	Tin/Lead	.400 (10,16)
714-AG10D	14	Gold		724-AG30D	24	Gold	
714-AG20D	14	Tin/Lead		724-AG40D	24	Tin/Lead	
716-AG10D	16	Gold	.600 (15,24)	728-AG30D	28	Gold	.600 (15,24)
716-AG20D	16	Tin/Lead		728-AG40D	28	Tin/Lead	
718-AG10D	18	Gold		732-AG30D	32	Gold	
718-AG20D	18	Tin/Lead	.300 (7,62)	732-AG40D	32	Tin/Lead	.300 (7,62)
720-AG10D	20	Gold		736-AG30D	36	Gold	
720-AG20D	20	Tin/Lead		736-AG40D	36	Tin/Lead	
722-AG10D	22	Gold	.400 (10,16)	740-AG30D	40	Gold	.400 (10,16)
722-AG20D	22	Tin/Lead		740-AG40D	40	Tin/Lead	
722-AG30D	22	Gold					
722-AG30D	22	Tin/Lead	.300 (7,62)				

### Need more technical information?

Consult your Thomas & Betts sales office listed on the back cover



# 800 Series *Four-Fingered Contact Open Insulator DIP Sockets*

A

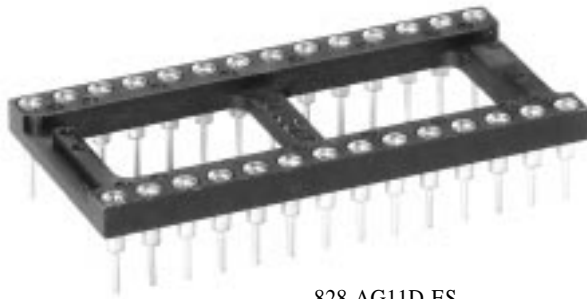

828-AG11D-ES

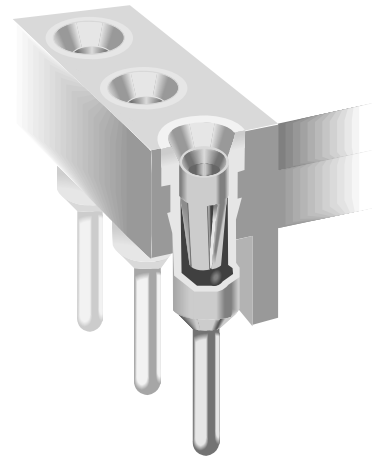

## FEATURES:

The Augat 800 Series combines precision four-fingered inner contacts with an open ladder insulator to produce the ultimate high-reliability socket.

- Precision four-fingered inner contacts provide concentric funnel entry for easy flat and round lead insertion
- “X” & “Y” stackable. Open ladder for cooling, cleaning and inspection. Low profile
- Accommodates 8 through 64 pins DIPS, rectangular or round IC leads
- Non-wicking, closed bottom sleeve provides 100% protection against flux and solder contamination. Choice of solderless wrap or PC termination
-  Recognized under the Component Program of Underwriter Laboratories, Inc. File No. E111362
- Beryllium copper inner contact for maximum mechanical and electrical performance
- Machined (Premium Series) and stamped (Economy Series) contacts are available
- For extreme conditions involving shock and vibration, Augat's high retention force contact is available

## APPLICATION DIMENSIONS:

- PCB Thickness Range: Standard .062" and .092" (1,57 and 2,34)
- PCB Hole Size Range:
  - .035" ± .002" (0,89 ± 0,05) PC tail,
  - .055" ± .003" (1,40 ± 0,08) solderless wrap
- IC Pin Dimension Range:
  - .009" x .015" (0,23 x 0,38) through
  - .011" x .020" (0,28 x 0,51)
  - .016" to .021" (0,41 to 0,53) round lead
  - .105" (2,67) min. length

## MATERIAL SPECIFICATIONS:

Insulator .....	Thermoplastic polyester, UL rated 94V-0
Sleeve .....	Machined brass
Contact .....	Beryllium copper
Sleeve Plating .....	Tin/lead or gold
Contact Plating .....	Premium or Economy Series (ES) - gold or tin/lead
	Economy Series (ESL) - low gold

## PERFORMANCE SPECIFICATIONS:

### MECHANICAL

Vibration .....	Passed MIL-STD-1344, Method 2005.1, Condition II, 10 G's
Shock .....	Passed MIL-STD-1344, Method 2004.1, Condition C, 100 G's
Durability .....	Passed MIL-STD-1344, Method 2016
Normal Force .....	125 Grams (4.4 oz.) average with .018" (0,46) dia. polished steel pin (Premium Series)
	200 Grams (7.1 oz.) average with .018" (0,46) dia. polished steel pin (Economy Series)
Inner Contact Retention .....	7.5 Lbs. per line average
Sleeve Retention in Plastic .....	3.0 Lbs. per line minimum
Solderability .....	Passed MIL-STD-202F, Method 208
Insertion Force .....	Premium - 134 grams (4.7 oz.) average with a .018" (0,46) dia. polished steel pin
	Economy - 179 grams (6.3 oz.) average with a .018" (0,46) dia. polished steel pin
Withdrawal Force .....	63 Grams (2.2 oz.) average with a (Premium and Economy) .018" (0,46) dia. polished steel pin

### ELECTRICAL

Contact Resistance .....	10 Milliohms max.
Contact Rating .....	3 Amps
Capacitance .....	1 pF per MIL-STD-202, Method 305 (contact to contact)
Insulation Resistance ....	5,000 Megohms min. @ 500 VDC per MIL-STD-1344, Method 3003.1
Dielectric Withstanding Voltage .....	1,000 Volts RMS per MIL-STD-1344, Method 3001.1

### ENVIRONMENTAL

Humidity .....	Passed MIL-STD-1344, Method 1002.2, Cond. II
Thermal Shock .....	Passed MIL-STD-1344, Method 1003.1, Cond. A
Operation Temperature ..	Gold inner contact -55°C to +125°C, Tin/lead inner contact -55°C to +105°C

# Four-Fingered Contact Open Insulator DIP Sockets 800 Series



## STANDARD CONFIGURATIONS

Number of Contacts	A	B*	C	Number of Contacts	A	B*	C
8	.400 (10,16)	.300 (7,62)	.400 (10,16)	24	1.200 (30,48)	.600 (15,24)	.700 (17,78)
14	.700 (17,78)			28	1.400 (35,56)		
16	.800 (20,32)			32	1.600 (40,64)		
18	.900 (22,86)			36	1.800 (45,72)		
20	1.000 (25,40)			40	2.000 (50,80)		
22	1.100 (27,94)	.400 (10,16)	.500 (12,70)	42	2.100 (53,34)	.900 (22,86)	1.000 (25,40)
24	1.200 (30,48)	.300 (7,62)	.400 (10,16)	48	2.400 (60,96)		
24		.400 (10,16)	.500 (12,70)	64	3.200 (81,28)		

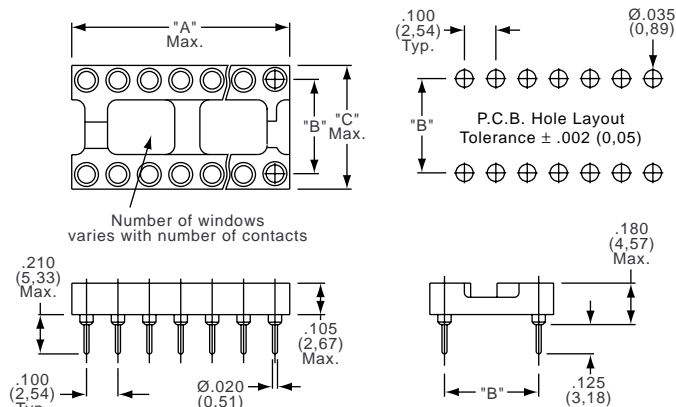

\* Dimension B ± .005 (0,13)

## PART NUMBERS

Economy Series	Premium Series	Position	Centerline	Contact	Sleeve	Economy Series	Premium Series	Position	Centerline	Contact	Sleeve
808-AG10D-ES	808-AG10D	8		Gold	Gold	824-AG10D-ES	824-AG10D	24		Gold	Gold
808-AG10D-ESL		8		Low Gold	Gold	824-AG10D-ESL		24		Low Gold	Gold
808-AG11D-ES	808-AG11D	8		Gold	Tin/Lead	824-AG11D-ES	824-AG11D	24		Gold	Tin/Lead
808-AG11D-ESL		8	.300 (7,62)	Low Gold	Tin/Lead	824-AG11D-ESL		24	.600 (15,24)	Low Gold	Tin/Lead
808-AG12D-ES	808-AG12D	8		Tin/Lead	Tin/Lead	824-AG12D-ES	824-AG12D	24		Tin/Lead	Tin/Lead
814-AG10D-ES	814-AG10D	14		Gold	Gold	828-AG10D-ES	828-AG10D	28		Gold	Gold
814-AG10D-ESL		14		Low Gold	Gold	828-AG10D-ESL		28		Low Gold	Gold
814-AG11D-ES	814-AG11D	14		Gold	Tin/Lead	828-AG11D-ES	828-AG11D	28		Gold	Tin/Lead
814-AG11D-ESL		14	.300 (7,62)	Low Gold	Tin/Lead	828-AG11D-ESL		28	.600 (15,24)	Low Gold	Tin/Lead
814-AG12D-ES	814-AG12D	14		Tin/Lead	Tin/Lead	828-AG12D-ES	828-AG12D	28		Tin/Lead	Tin/Lead
816-AG10D-ES	816-AG10D	16		Gold	Gold	832-AG10D-ES	832-AG10D	32		Gold	Gold
816-AG10D-ESL		16		Low Gold	Gold	832-AG10D-ESL		32		Low Gold	Gold
816-AG11D-ES	816-AG11D	16		Gold	Tin/Lead	832-AG11D-ES	832-AG11D	32		Gold	Tin/Lead
816-AG11D-ESL		16	.300 (7,62)	Low Gold	Tin/Lead	832-AG11D-ESL		32	.600 (15,24)	Low Gold	Tin/Lead
816-AG12D-ES	816-AG12D	16		Tin/Lead	Tin/Lead	832-AG12D-ES	832-AG12D	32		Tin/Lead	Tin/Lead
818-AG10D-ES	818-AG10D	18		Gold	Gold	836-AG10D-ES	836-AG10D	36		Gold	Gold
818-AG10D-ESL		18		Low Gold	Gold	836-AG10D-ESL		36		Low Gold	Gold
818-AG11D-ES	818-AG11D	18		Gold	Tin/Lead	836-AG11D-ES	836-AG11D	36		Gold	Tin/Lead
818-AG11D-ESL		18	.300 (7,62)	Low Gold	Tin/Lead	836-AG11D-ESL		36	.600 (15,24)	Low Gold	Tin/Lead
818-AG12D-ES	818-AG12D	18		Tin/Lead	Tin/Lead	836-AG12D-ES	836-AG12D	36		Tin/Lead	Tin/Lead
820-AG10D-ES	820-AG10D	20		Gold	Gold	840-AG10D-ES	840-AG10D	40		Gold	Gold
820-AG10D-ESL		20		Low Gold	Gold	840-AG10D-ESL		40		Low Gold	Gold
820-AG11D-ES	820-AG11D	20		Gold	Tin/Lead	840-AG11D-ES	840-AG11D	40		Gold	Tin/Lead
820-AG11D-ESL		20	.300 (7,62)	Low Gold	Tin/Lead	840-AG11D-ESL		40	.600 (15,24)	Low Gold	Tin/Lead
820-AG12D-ES	820-AG12D	20		Tin/Lead	Tin/Lead	840-AG12D-ES	840-AG12D	40		Tin/Lead	Tin/Lead
822-AG10D-ES	822-AG10D	22		Gold	Gold	842-AG10D-ES	842-AG10D	42		Gold	Gold
822-AG10D-ESL		22		Low Gold	Gold	842-AG10D-ESL		42		Low Gold	Gold
822-AG11D-ES	822-AG11D	22		Gold	Tin/Lead	842-AG11D-ES	842-AG11D	42		Gold	Tin/Lead
822-AG11D-ESL		22	.400 (10,16)	Low Gold	Tin/Lead	842-AG11D-ESL		42	.600 (15,24)	Low Gold	Tin/Lead
822-AG12D-ES	822-AG12D	22		Tin/Lead	Tin/Lead	842-AG12D-ES	842-AG12D	42		Tin/Lead	Tin/Lead
824-AG30D-ES	824-AG30D	24		Gold	Gold	848-AG10D-ES	848-AG10D	48		Gold	Gold
824-AG30D-ESL		24		Low Gold	Gold	848-AG10D-ESL		48		Low Gold	Gold
824-AG31D-ES	824-AG31D	24		Gold	Tin/Lead	848-AG11D-ES	848-AG11D	48		Gold	Tin/Lead
824-AG31D-ESL		24	.300 (7,62)	Low Gold	Tin/Lead	848-AG11D-ESL		48	.600 (15,24)	Low Gold	Tin/Lead
824-AG32D-ES	824-AG32D	24		Tin/Lead	Tin/Lead	848-AG12D-ES	848-AG12D	48		Tin/Lead	Tin/Lead
824-AG65D-ES	824-AG65D	24		Gold	Gold	864-AG10D-ES	864-AG10D	64		Gold	Gold
824-AG65D-ESL		24		Low Gold	Gold	864-AG10D-ESL		64		Low Gold	Gold
824-AG66D-ES	824-AG66D	24		Gold	Tin/Lead	864-AG11D-ES	864-AG11D	64		Gold	Tin/Lead
824-AG66D-ESL		24	.400 (10,16)	Low Gold	Tin/Lead	864-AG11D-ESL		64	.900 (22,86)	Low Gold	Tin/Lead
824-AG14D-ES	824-AG14D	24		Tin/Lead	Tin/Lead	864-AG12D-ES	864-AG12D	64		Tin/Lead	Tin/Lead

Economy and Premium Series - .180" (4,57) PC Tail Pins

- 8XX-AG44D-XXX - Gold contact, tin/lead sleeve
- 8XX-AG45D-XXX - Gold contact, gold sleeve
- 8XX-AG43D-XXX - Tin/lead contact, tin/lead sleeve

High Retention Series

- 8XX-AG34D - Gold contact, tin/lead sleeve
- 8XX-AG33D - Gold contact, gold sleeve
- 8XX-AG38D - Tin/lead contact, tin/lead sleeve

Note: Part numbers in this chart and in detail shown refer to a .125" (3,18) PC Tail Pin

For wire-wrap sockets or 24 position on .300" (7,62) or .400" (10,16) in high retention or .180" (4,57) tails, please consult factory.

### Need more technical information?

Consult your Thomas & Betts sales office listed on the back cover



# 800SM Series *Surface Mount DIP Sockets*

A



814-AG11SM

## FEATURES:

Augat offers the precision machined 800SM Series which achieves compliancy to the board surface and is designed for high temperatures typical of vapor phase and infrared reflow soldering.

- “Butt” style terminals float in plastic housing for compliancy to board surface
- Precision four-fingered inner contacts provide concentric funnel entry for easy flat or round insertion

## APPLICATION DIMENSIONS:

- PCB Thickness Range: Standard .062" and .092" (1,57 and 2,34)
- IC Pin Dimension Range: .009" x .015" (0,23 x 0,38) through .011" x .020" (0,28 x 0,51)  
.016" to .021" (0,41 to 0,53) round lead  
.105" (2,67) min. length

## MATERIAL SPECIFICATIONS:

Insulator ..... Thermoplastic polyester, UL rated 94V-0  
Outer Sleeve ..... Brass  
Contacts ..... Beryllium copper  
Sleeve Plating ..... Tin/lead  
Contact Plating ..... Gold or tin/lead

## PERFORMANCE SPECIFICATIONS:

### MECHANICAL

Vibration ..... Passed MIL-STD-1344, Method 2005.1, Condition II, 10 G's  
Shock ..... Passed MIL-STD-1344, Method 2004.1, Condition C, 100 G's  
Durability ..... Passed MIL-STD-1344, Method 2016  
Inner Contact Retention ..... 7.5 Lbs. per line average  
Solderability ..... Passed MIL-STD-202F, Method 208  
Insertion Force ..... 179 Grams (6.3 oz.) average with a .018" (0,46) dia. polished steel pin  
Withdrawal Force ..... 63 Grams (2.2 oz.) average with a .018" (0,46) dia. polished steel pin

### ELECTRICAL

Contact Resistance ..... 10 Milliohms max.  
Contact Rating ..... 3 Amps  
Capacitance ..... 1.0 pF per MIL-STD-202, Method 305 (contact to contact)  
Insulation Resistance .... 5,000 Megohms min. @ 500 VDC per MIL-STD-1344, Method 3003.1  
Dielectric Withstanding Voltage ..... 1,000 Volts RMS per MIL-STD-1344, Method 3001.1

### ENVIRONMENTAL

Humidity ..... Passed MIL-STD-1344, Method 1002.2, Cond. II  
Thermal Shock ..... Passed MIL-STD-1344, Method 1003.1, Cond. A  
Operation Temperature .. Gold inner contact -55°C to +125°C,  
Tin/lead inner contact -55°C to +105°C

# Surface Mount DIP Sockets 800SM Series

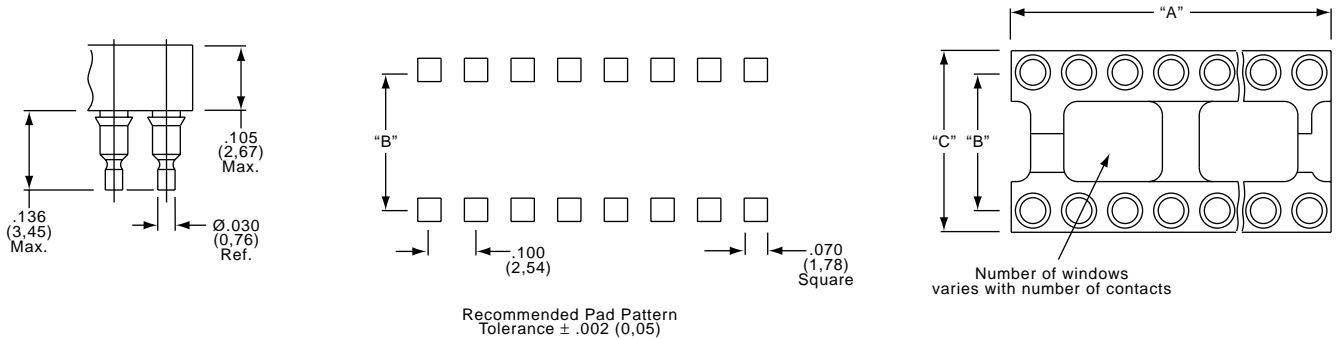

## STANDARD CONFIGURATIONS

Number of Contacts	A	B*	C	Number of Contacts	A	B*	C		
8	.400 (10,16)	.300 (7,62)	.400 (10,16)	24	1.200 (30,48)	.600 (15,24)	.700 (17,78)		
14	.700 (17,78)			28	1.400 (35,36)				
16	.800 (20,32)			32	1.600 (40,64)				
18	.900 (22,86)			36	1.800 (45,72)				
20	1.000 (25,40)			40	2.000 (50,80)				
22	1.100 (27,94)	.400 (10,16)	.500 (12,70)	42	2.100 (53,34)				
24	1.200 (30,48)	.300 (7,62)	.400 (10,16)	48	2.400 (60,96)				
24	1.200 (30,48)	.400 (10,16)	.500 (12,70)	64	3.200 (81,28)			.900 (22,86)	1.000 (25,40)

\* Dimension B ± .005  
(0,13)

## PART NUMBERS

Part Number	Position	Centerline	Contact	Part Number	Position	Centerline	Contact
808-AG11SM	8	.300	Gold	824-AG11SM	24	.600	Gold
808-AG12SM	8	(7,62)	Tin/Lead	824-AG12SM	24	(15,24)	Tin/Lead
814-AG11SM	14	.300	Gold	828-AG11SM	28	.600	Gold
814-AG12SM	14	(7,62)	Tin/Lead	828-AG12SM	28	(15,24)	Tin/Lead
816-AG11SM	16	.300	Gold	832-AG11SM	32	.600	Gold
816-AG12SM	16	(7,62)	Tin/Lead	832-AG12SM	32	(15,24)	Tin/Lead
818-AG11SM	18	.300	Gold	836-AG11SM	36	.600	Gold
818-AG12SM	18	(7,62)	Tin/Lead	836-AG12SM	36	(15,24)	Tin/Lead
820-AG11SM	20	.300	Gold	840-AG11SM	40	.600	Gold
820-AG12SM	20	(7,62)	Tin/Lead	840-AG12SM	40	(15,24)	Tin/Lead
822-AG11SM	22	.300	Gold	842-AG11SM	42	.600	Gold
822-AG12SM	22	(7,62)	Tin/Lead	842-AG12SM	42	(15,24)	Tin/Lead
824-AG31SM	24	.300	Gold	848-AG11SM	48	.600	Gold
824-AG32SM	24	(7,62)	Tin/Lead	848-AG12SM	48	(15,24)	Tin/Lead
824-AG66SM	24	.400	Gold	864-AG11SM	64	.900	Gold
824-AG14SM	24	(10,16)	Tin/Lead	864-AG12SM	64	(22,86)	Tin/Lead

Need more technical information?

Consult your Thomas & Betts sales office listed on the back cover

# 2400 Series *Shrink DIP Sockets (.070 Pitch)*

A

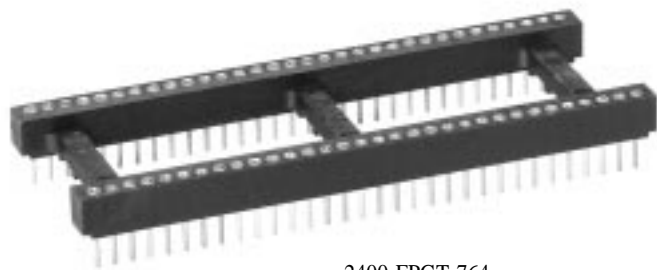

2400-FPGT-764

## FEATURES:

The Augat 2400 Series enables the user to reliably remove or replace shrink DIP devices (devices on .070 centerline).

- Sleeve body incorporated in socket reduces the risk of solder bridging during wave solder
- Open ladder design to permit device cooling
- Open ladder design makes available additional space within socket for component placement
- Non-wicking, closed bottom, machined sleeve protects 100% against flux or solder contamination
- Concentric funnel entry for easy insertion of flat or round IC leads
-  Recognized under the Component Program of Underwriters Laboratories, Inc. File No. E111362

## APPLICATION DIMENSIONS:

- PCB Thickness Range: Standard .062" (1,57)
- PCB Hole Size Range: .035"± .003" (0,89 ± 0,08)
- IC Pin Dimension Range: .016" to .021" (0,41 to 0,53) dia. .105" (2,67) min. length

## MATERIAL SPECIFICATIONS:

Insulator ..... Thermoplastic polyester UL rated 94V-0  
Outer Sleeve ..... Machined brass/formed copper, tin/lead plated  
Inner Contact ..... Beryllium copper, gold or tin/lead plated

## PERFORMANCE SPECIFICATIONS:

### MECHANICAL

Vibration ..... Passed MIL-STD-1344, Method 2005.1, Condition II, 10 G's  
Shock ..... Passed MIL-STD-1344, Method 2004.1, Condition C, 100 G's  
Durability ..... Passed MIL-STD-1344, Method 2016  
Normal Force ..... 200 Grams with .018" (0,46) dia. polished steel pin (typ.)  
Inner Contact Retention ..... 7.5 Lbs. per line average  
Sleeve Retention in Plastic ..... 3.0 Lbs. per line minimum  
Solderability ..... Passed MIL-STD-202F, Method 208  
Insertion Force ..... 179 grams (6.3 oz.) average with a .018" (0,46) dia. polished steel pin  
Withdrawal Force ..... 63 Grams (2.2 oz.) average with a .018" (0,46) dia. polished steel pin

### ELECTRICAL

Contact Resistance ..... 10 Milliohms max.  
Contact Rating ..... 3 Amps  
Capacitance ..... 1.0 pF per MIL-STD-202, Method 305 (contact to contact)  
Insulation Resistance .... 5,000 Megohms min. @ 500 VDC per MIL-STD-1344, Method 3003.1  
Dielectric Withstanding Voltage ..... 1,000 Volts RMS per MIL-STD-1344, Method 3001.1

### ENVIRONMENTAL

Humidity ..... Passed MIL-STD-1344, Method 1002.2, Cond. II  
Thermal Shock ..... Passed MIL-STD-1344, Method 1003.1, Cond. A  
Operation Temperature .. Gold inner contact -55°C to +125°C,  
Tin/lead inner contact -55°C to +105°C

# Shrink DIP Sockets (.070 Pitch) 2400 Series

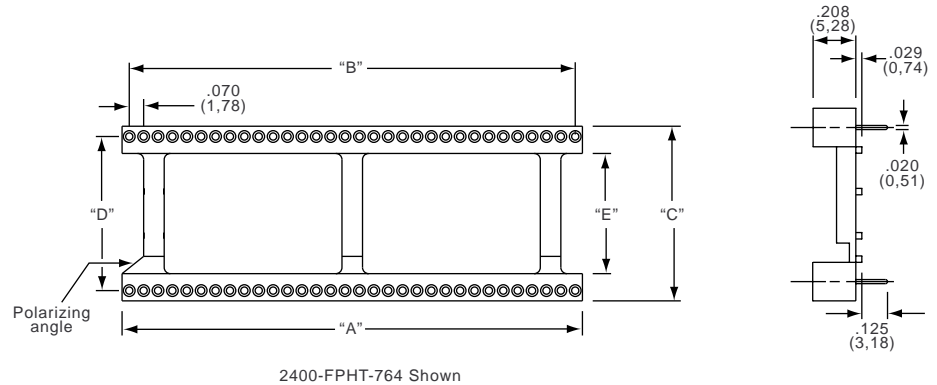

2400-FPHT-764 Shown

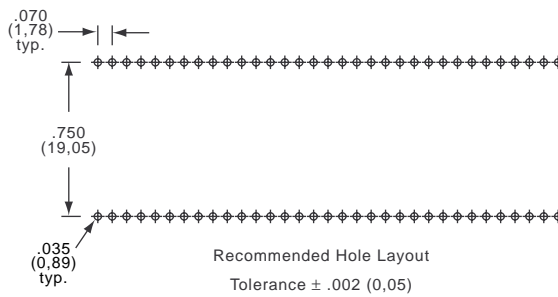

Recommended Hole Layout  
Tolerance ± .002 (0,05)

## STANDARD CONFIGURATIONS

Number of Contacts	A	B	C	D	E
48	1.743 (44,27)	1.610 (40,89)	.497 (17,68)	.600 (15,24)	.436 (11,07)
52	1.883 (47,83)	1.750 (44,45)	.497 (17,68)	.600 (15,24)	.436 (11,07)
64	2.300 (58,42)	2.176 (55,27)	.846 (21,49)	.750 (19,05)	.585 (14,86)

## PART NUMBERS

Part Number	Position	Centerline	Contact Plating	Sleeve Plating
2400-FPHT-648 2400-FPGT-648 2400-FPPT-648	48	.600 (15,24)	Gold Low Gold Tin/Lead	Tin/Lead Tin/Lead Tin/Lead
2400-FPHT-652 2400-FPGT-652 2400-FPPT-652	52	.600 (15,24)	Gold Low Gold Tin/Lead	Tin/Lead Tin/Lead Tin/Lead
2400-FPHT-764 2400-FPGT-764 2400-FPPT-764	64	.750 (19,05)	Gold Low Gold Tin/Lead	Tin/Lead Tin/Lead Tin/Lead

Need more technical information?

Consult your Thomas & Betts  
sales office listed on the back cover

# DS Series *Capacitor Socket With Four-Finger Contact*

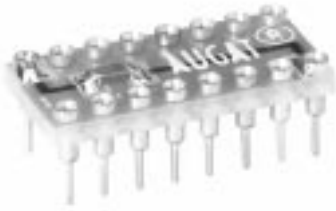

DS1-316-1AR

## FEATURES:

Augat has combined its four-finger high reliability contact with a surface mount capacitor and a circuit assembly to create a full line of decoupling (dual-in-line) sockets.

- Available in three lead termination styles, .125" (3,18) PC tail, .180" (4,57) PC tail and 3-level solderless wire wrap
- Reduces PCB utilized space by 12% to 15%
- Allows handling, inventory and installation of one component instead of two
- Available in three capacitor values: .01 $\mu$ F, .10 $\mu$ F and .33 $\mu$ F
- Optional assignment of voltage and ground available for custom decoupling requirements, consult factory

## APPLICATION DIMENSIONS:

- PCB Hole Size Range: .055"  $\pm$  .003" (1,40  $\pm$  0,08) Solderless wrap  
.035"  $\pm$  .003" (0,89  $\pm$  0,08) PC solder termination
- IC Pin Dimension Range: .016" to .021" (0,41 to 0,53) dia.  
.105" (2,67) min. length

## MATERIAL SPECIFICATIONS:

Insulator ..... Glass epoxy  
Outer Sleeve ..... Machined brass/formed copper,  
tin/lead or gold plated  
Inner Contact ..... Beryllium copper, gold over nickel  
or tin/lead plated

## PERFORMANCE SPECIFICATIONS:

### MECHANICAL

Vibration ..... Passed MIL-STD-1344, Method 2005.1, Cond. II  
Shock ..... Passed MIL-STD-1344, Method 2004.1, Cond. C  
Durability ..... Passed 50 cycles  
Normal Force ..... 115 Grams (4.1 Oz.) min. with .018" (0,46) dia.  
polished steel pin (typ.)  
Inner Contact  
Retention ..... 7.5 Lbs. per line average  
Solderability ..... Passed MIL-STD-202, Method 208  
Insertion Force ..... 179 Grams (6.3 oz.) average with .018" (0,46) dia.  
polished steel pin  
Withdrawal Force ..... 63 Grams (2.2 oz.) average with .018" (0,46) dia.  
polished steel pin

### ELECTRICAL

Contact Resistance ..... 10 Milliohms  
Contact Rating ..... 3 Amps  
Capacitance ..... 1.0 pF per MIL-STD-202F, Method 305  
(adjacent contacts max.)  
Insulation Resistance .... 5,000 Megohms @ 500 VDC per MIL-STD-1344,  
Method 3003.1  
Dielectric Withstanding  
Voltage ..... 1,000 VAC RMS per MIL-STD-1344,  
Method 3001.1

### ENVIRONMENTAL

Moisture Resistance ..... Passed MIL-STD-202, Method 106  
Temperature Cycling .... Passed MIL-STD-1344, Method 1003.1, Cond. A  
Operation Temp.\* ..... +10°C to +85°C

\* This temperature range applies to the capacitor only

# Capacitor Socket With Four-Finger Contact DS Series

## STANDARD CONFIGURATIONS

Number of Contacts	A	B*	C	Number of Contacts	A	B*	C	
8	.400 (10,16)	.300 (7,62)	.400 (10,16)	24	1.200 (30,48)	.400 (10,16)	.500 (12,70)	
14	.700 (17,78)			24	1.200 (30,48)	.600 (15,24)	.700 (17,78)	
16	.800 (20,32)			28	1.400 (35,56)	.300 (7,62)	.400 (10,16)	
18	.900 (22,86)			28	1.400 (35,56)	.600 (15,24)	.700 (17,78)	
20	1.000 (25,40)			32	1.600 (40,64)			
22	1.100 (27,94)			40	2.000 (50,80)			
22	.400 (10,16)			.500 (12,70)	48	2.400 (60,96)		
24	1.200 (30,48)			.300 (7,62)	.400 (10,16)			

\* Dimension B ± .005  
(0,13)

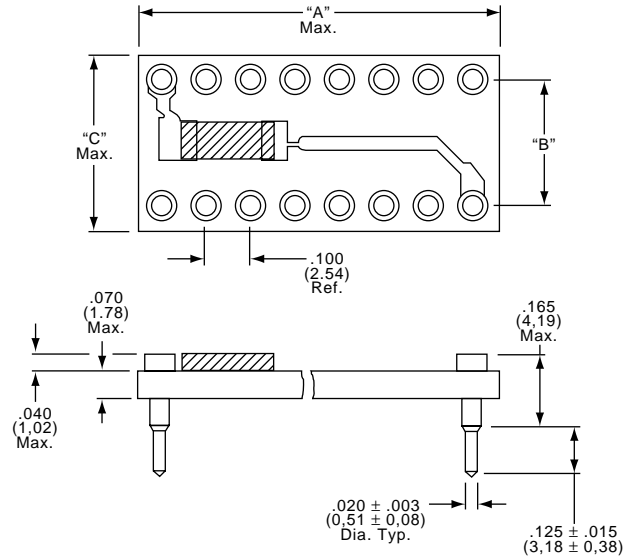

## HOW TO ORDER

.01µF Capacitor	.10µF Capacitor	.33µF Capacitor	Position	Centerline	Contact	Sleeve	
DS1-308-1AR	DS2-308-1AR	DS3-308-1AR	8	.300 (7,62)	Gold	Tin/Lead	
DS1-308-2AR	DS2-308-2AR	DS3-308-2AR			Gold	Gold	
DS1-314-1AR	DS2-314-1AR	DS3-314-1AR	14		Gold	Tin/Lead	
DS1-314-2AR	DS2-314-2AR	DS3-314-2AR			Gold	Gold	
DS1-316-1AR	DS2-316-1AR	DS3-316-1AR	16		Gold	Tin/Lead	
DS1-316-2AR	DS2-316-2AR	DS3-316-2AR			Gold	Gold	
DS1-318-1AR	DS2-318-1AR	DS3-318-1AR	18		Gold	Tin/Lead	
DS1-318-2AR	DS2-318-2AR	DS3-318-2AR			Gold	Gold	
DS1-320-1AR	DS2-320-1AR	DS3-320-1AR	20		Gold	Tin/Lead	
DS1-320-2AR	DS2-320-2AR	DS3-320-2AR			Gold	Gold	
DS1-322-1AR	DS2-322-1AR	DS3-322-1AR	22	Gold	Tin/Lead		
DS1-322-2AR	DS2-322-2AR	DS3-322-2AR		Gold	Gold		
DS1-324-1AR	DS2-324-1AR	DS3-324-1AR	24	Gold	Tin/Lead		
DS1-324-2AR	DS2-324-2AR	DS3-324-2AR		Gold	Gold		
DS1-422-1AR	DS2-422-1AR	DS3-422-1AR	22	.400 (10,16)	Gold	Tin/Lead	
DS1-422-2AR	DS2-422-2AR	DS3-422-2AR			Gold	Gold	
DS1-424-1AR	DS2-424-1AR	DS3-424-1AR	24		Gold	Tin/Lead	
DS1-424-2AR	DS2-424-2AR	DS3-424-2AR			Gold	Gold	
DS1-624-1AR	DS2-624-1AR	DS3-624-1AR	24		.600 (15,24)	Gold	Tin/Lead
DS1-624-2AR	DS2-624-2AR	DS3-624-2AR			Gold	Gold	
DS1-328-1AR	DS2-328-1AR	DS3-328-1AR	28		.300 (7,62)	Gold	Tin/Lead
DS1-328-2AR	DS2-328-2AR	DS3-328-2AR			Gold	Gold	
DS1-628-1AR	DS2-628-1AR	DS3-628-1AR	28		.600 (15,24)	Gold	Tin/Lead
DS1-628-2AR	DS2-628-2AR	DS3-628-2AR				Gold	Gold
DS1-632-1AR	DS2-632-1AR	DS3-632-1AR	32	Gold		Tin/Lead	
DS1-632-2AR	DS2-632-2AR	DS3-632-2AR		Gold		Gold	
DS1-640-1AR	DS2-640-1AR	DS3-640-1AR	40	Gold		Tin/Lead	
DS1-640-2AR	DS2-640-2AR	DS3-640-2AR		Gold		Gold	
DS1-648-1AR	DS2-648-1AR	DS3-648-1AR	48	Gold		Tin/Lead	
DS1-648-2AR	DS2-648-2AR	DS3-648-2AR		Gold		Gold	

.180 PC Tails available

DSX-XXX-1BR, gold contact, tin/lead sleeve  
DSX-XXX-2BR, gold contact, tin/lead sleeve

For 3-level wire-wrap termination, please consult the factory.

Note: Part numbers in chart and in detail refer to a .125" (3,18) PC tail pin.

## Need more technical information?

Consult your Thomas & Betts  
sales office listed on the back cover

A21

Thomas & Betts  
1555 Lynnfield Road  
Memphis, TN 38119  
(901) 682-8221 FAX (901) 537-8805

# MCK Series *DIP Sockets*

A



MCK-RGHT-316

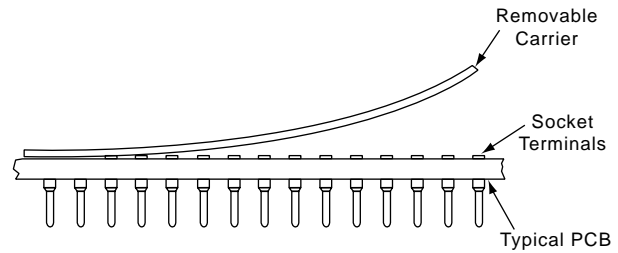

## FEATURES:

The Augat VisInPak™ Family allows gang mounting of socket terminals without the need for a permanent insulator. The removable carrier withstands temperature up to 400°C, typical of soldering, vapor phase and infrared processed. Various terminal choices provide a full range of mounting profiles.

- Available in all DIP patterns
- Four socket profiles
- The Visual Inspection Package provides easy cleaning and solder joint inspection

## APPLICATION DIMENSIONS:

Contact Styles: H, R, B

- PCB Thickness Range: Standard .062" and .092" (1,57 and 2,34)
- IC Pin Dimension Range: .016" to .021" (0,41 to 0,53) dia. .105" (2,67) min. length

Contact Style: A

- PCB Thickness Range: Standard .062" and .092" (1,57 and 2,34)
- IC Pin Dimension Range: .016" to .019" (0,41 to 0,48) dia. .100" (2,54) min. length

## MATERIAL SPECIFICATIONS:

Carrier ..... KAPTON® or equivalent  
 Inner Contact ..... Beryllium copper, gold or tin/lead plated  
 Outer Sleeve ..... Brass or copper, gold or tin/lead plated

## PERFORMANCE SPECIFICATIONS:

### MECHANICAL

#### Vibration

- Type H, R, A ..... Passed MIL-STD-1344, Method 2005.1, Condition III, 15 G's
- Type B ..... Passed MIL-STD-1344, Method 2005.1, Condition V/J

#### Shock

- Type H, R, A ..... Passed MIL-STD-1344, Method 2004.1, Condition G, 100 G's
- Type B ..... Passed MIL-STD-202F, Method 213, Condition I

Durability ..... Passed MIL-STD-1344, Method 2016

#### Normal Force

- Type H & R ..... 115 Grams (4.1 oz.) with .018" (0,46) dia. polished steel pin
- Type B ..... 238 Grams (8.4 oz.) with .018" (0,46) dia. polished steel pin
- Type A ..... 35 Grams (1.2 oz.) with .018" (0,46) dia. polished steel pin

#### Inner Contact

Retention ..... 7.5 Lbs. per line average

Solderability ..... Passed MIL-STD-202F, Method 208

Insertion Force with .018" (0,46) dia. polished steel pin

- Type H ..... 134 Grams (4.7 oz.)
- Type R ..... 179 Grams (6.3 oz.)
- Type B ..... 344 Grams (12.0 oz.)
- Type A ..... 81 Grams (2.9 oz.)

Withdrawal Force with .018" (0,46) dia. polished steel pin

- Type H ..... 77 Grams (2.5 oz.)
- Type R ..... 63 Grams (2.2 oz.)
- Type B ..... 174 Grams (6.1 oz.)
- Type A ..... 50 Grams (1.8 oz.)

### ELECTRICAL

Contact Resistance ..... 10 Milliohms

Contact Rating ..... 3 Amps

Capacitance ..... 1.0 pF per MIL-STD-202F, Method 305 (contact to contact)

### ENVIRONMENTAL

Humidity ..... Passed MIL-STD-1344, Method 1002.2

Thermal Shock ..... Passed MIL-STD-1344, Method 1003.1

Operation Temp. .... Gold inner contact -55°C to +125°C,  
 Tin/lead inner contact -55°C to +105°C



**TABLE 2 - PIN SELECTION**

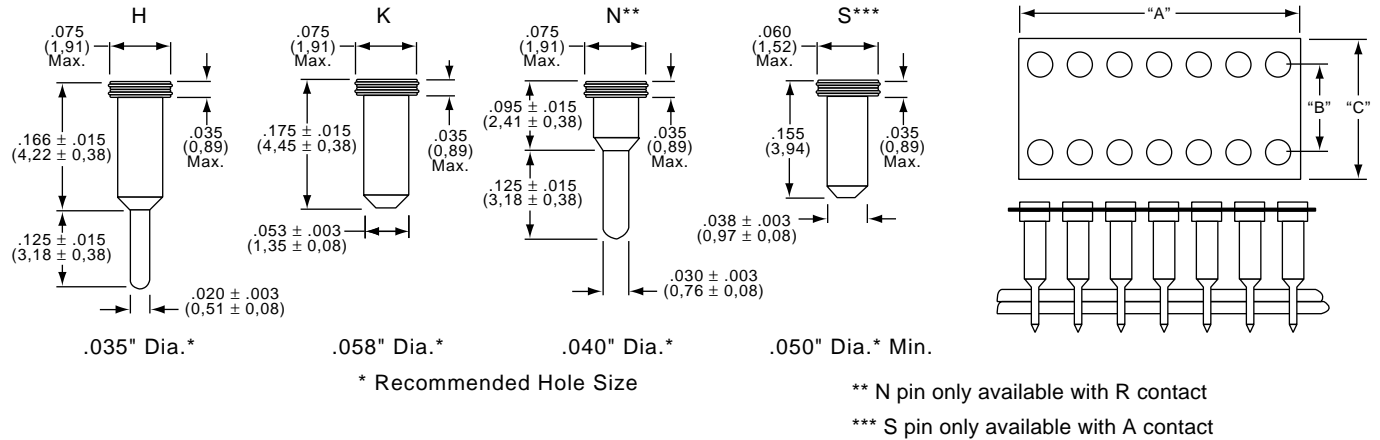

**TABLE 3 - DIP STANDARD CONFIGURATIONS**

Number of Contacts	Dim. "A" ± .025 (0,64)	Dim. "B" (Typ.)	Dim. "C" ± .025 (0,64)	Number of Contacts	Dim. "A" ± .025 (0,64)	Dim. "B" (Typ.)	Dim. "C" ± .025 (0,64)
6	.300 (7,62)	.300 (7,62)	.200 (5,08)	28	1.400 (35,56)	.600 (15,24)	.700 (17,78)
8	.400 (10,16)	.300 (7,62)	.400 (10,16)	32	1.600 (40,64)	.600 (15,24)	.700 (17,78)
14	.700 (17,78)	.300 (7,62)	.400 (10,16)	32	1.600 (40,64)	.900 (22,86)	1.000 (25,4)
16	.800 (20,32)	.300 (7,62)	.400 (10,16)	36	1.800 (45,72)	.600 (15,24)	.700 (17,78)
18	.900 (22,86)	.300 (7,62)	.400 (10,16)	40	2.000 (50,80)	.600 (15,24)	.700 (17,78)
20	1.000 (25,4)	.300 (7,62)	.400 (10,16)	42	2.100 (53,34)	.600 (15,24)	.700 (17,78)
22	1.100 (27,94)	.400 (10,16)	.500 (12,70)	48	2.400 (60,96)	.600 (15,24)	.700 (17,78)
22	1.100 (27,94)	.300 (7,62)	.400 (10,16)	50	2.500 (63,50)	.900 (22,86)	1.000 (25,4)
24	1.200 (30,48)	.300 (7,62)	.400 (10,16)	52	2.600 (66,04)	.600 (15,24)	.700 (17,78)
24	1.200 (30,48)	.600 (15,24)	.700 (17,78)	52	2.600 (66,04)	.900 (22,86)	1.000 (25,4)
24	1.200 (30,48)	.400 (10,16)	.500 (12,70)	64	3.200 (81,28)	.900 (22,86)	1.000 (25,4)
28	1.400 (35,56)	.300 (7,62)	.400 (10,16)				

**HOW TO ORDER**

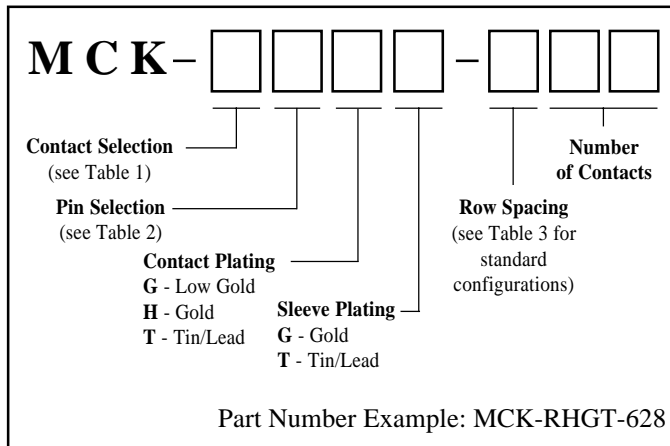

**TABLE 1 - CONTACT SELECTION**

Letter	Contact Features
H	Normal Force (machined)
R	Normal Force (stamped)
B	High Force (machined)
A	Normal Force (stamped)

\*\* N pin only available with R contact. \*\*\* S pin only available with A contact.

QUAD and ZIP Patterns available. Please consult factory. For SIP Patterns, see page B4.

**Need more technical information?**  
 Consult your Thomas & Betts sales office listed on the back cover



# Holtite® Series *Zero Profile Solderless DIP Sockets on Reel*

A



322-HCSSP2-314

## FEATURES:

The solderless zero-profile Holtite® contact is designed to be press-fit into the plated-thru hole of a printed wiring board. This unique design allows the plated-thru hole to become the component socket. The outer conical shape of the Holtite® contact sizes the plated-thru hole when pressed into place. The precision-machined geometry allows for the controlled displacement of plated material without damaging the hole, or affecting the normal mechanical and electrical contact performance.

- **Lowest socket profile**  
The profile of the printed wiring board with the Holtite® contact installed is less than the length of the IC or component lead, offering the lowest socketing profile, permitting card rack spacing as low as .400", identical to that of direct soldering.
- **Precision-machined, tapered-entry, four finger contact**  
The underlying contact design used in the Holtite® system has a proven record of reliability after more than fifteen years' usage in both commercial and military applications.
- **Retains minimum component lead lengths**  
The socketing technique provides the shortest distance between the component seating plane and the contact engagement zone for maximum retention of short component leads.
- **Maximum heat dissipation**  
Open contact design permits air flow through the board, increasing heat dissipation and extending component life.
- **Solderless, gas-tight, press-fit insertion**  
The solderless, pluggable system saves the time and cost of soldering, plus eliminating the potential for heat damage, warpage and corrosive residue contamination..
- **Removes artwork design restrictions**  
Use of the Holtite® solderless system removes certain artwork restrictions necessary for wave soldering and solder joint construction. Line spacing can be made as tight as electrical parameters allow without solder bridging or the need for soldermask. Terminal areas can be reduced in diameter without the need of a base for solder fillets. Ground plane areas can be increased without concern for heat-induced warpage.
- **Immediate conversion to the Holtite® system**  
Existing printed wiring designs can be converted by simply changing the drilled hole diameter prior to plating.

## MATERIAL SPECIFICATIONS:

- Carrier Strip ..... Mylar
- Contact ..... Beryllium copper
- Finish ..... Gold or tin/lead plated

## PERFORMANCE SPECIFICATIONS:

### MECHANICAL

- Vibration ..... Passed MIL-STD-202, Method 204, 20 G's
- Durability ..... Passed MIL-STD-1344, Method 2016, 50 cycles
- Insertion Force ..... 92 Grams (3.2 oz.) average with a .018" (0,46) pol. steel pin and .043" (1,09) plated thru hole
- Withdrawal Force ..... 103 Grams (3.6 oz.) average with a .018" (0,46) pol. steel pin and .043" (1,09) plated thru hole
- Contact Retention in Board ..... 5 Lb. minimum

### ELECTRICAL

- Contact Resistance ..... 10 Milliohms max.
- Contact Rating ..... 3 Amps

### ENVIRONMENTAL

- Humidity ..... Passed MIL-STD-202, Method 106
- Thermal Shock ..... Passed MIL-STD-202, Method 107, Cond. F
- Operation Temp. .... Gold contact -55°C to +125°C,  
Tin/lead contact -55°C to +105°C

