

San Ace 140

9GV type

High Airflow Fan

Features

High Airflow and High Static Pressure

- Maximum airflow increased by approximately 2 times and maximum static pressure increased by approximately 6.8 times compared with our conventional DC fan.*
- Servers, ICT devices and power supplies are becoming denser and generating more heat.
- Offers effective cooling even for these devices with its greatly increased static pressure.

*: Our conventional DC fan is 140 x 140 x 38 mm "San Ace 140 9P type", Model No. 109P1412H101.



140×140×38mm

Specifications

The following nos. have **PWM controls, pulse sensors.**

Model no.	Rated voltage [V]	Operating voltage range [V]	PWM duty cycle (Note1, 2) [%]	Rated current [A]	Rated input [W]	Rated speed [min ⁻¹]	Max. airflow [m ³ /min] [CFM]	Max. static pressure [Pa] [inchH ₂ O]	SPL [dB(A)]	Operating temperature [°C]	Expected life [h]
9GV1412P1G001	12	10.8 to 13.2	100	4.6	55.20	7,600	8.80 310	640 2.57	70	-20 to +70	40,000 / 60 °C
			20	0.26	3.12	2,300	2.66 93	80 0.32	39		
9GV1412P1S001			100	3.1	37.20	6,650	7.70 272	480 1.93	67		
			20	0.26	3.12	2,300	2.66 93	80 0.32	39		
9GV1412P1H001			100	1.7	20.40	5,200	6.00 212	300 1.20	62		
			20	0.26	3.12	2,300	2.66 93	80 0.32	39		
9GV1424P1G001	24	21.6 to 26.4	100	2.3	55.20	7,600	8.80 310	640 2.57	70		
			20	0.13	3.12	2,300	2.66 93	80 0.32	39		
9GV1424P1S001			100	1.55	37.20	6,650	7.70 272	480 1.93	67		
			20	0.13	3.12	2,300	2.66 93	80 0.32	39		
9GV1424P1H001			100	0.85	20.40	5,200	6.00 212	300 1.20	62		
			20	0.13	3.12	2,300	2.66 93	80 0.32	39		
9GV1448P1G001	48	36 to 60	100	1.15	55.20	7,600	8.80 310	640 2.57	70		
			20	0.11	5.28	2,300	2.66 93	80 0.32	39		
9GV1448P1S001			100	0.78	37.44	6,650	7.70 272	480 1.93	67		
			20	0.11	5.28	2,300	2.66 93	80 0.32	39		
9GV1448P1H001			100	0.42	20.16	5,200	6.00 212	300 1.20	62		
			20	0.11	5.28	2,300	2.66 93	80 0.32	39		

Note1: PWM frequency: 25 kHz Note2: Fans do not rotate when PWM duty cycle is 0%.

Available options: ⇒ **Without sensor** Please inquire as the availability of these functions depends on the model. ⇒ **Lock sensor**

Common Specifications

- Material Frame: Aluminum, Impeller: Plastics (Flammability: UL94V-1)
- Expected life Refer to specifications
(L10: Survival rate: 90% at 60 °C, rated voltage, and continuously run in a free air state)
- Motor protection system Current blocking function and reverse polarity protection
- Dielectric strength 50 / 60 Hz, 500 VAC, 1 minute (between lead conductor and frame)
- Sound pressure level (SPL) Expressed as the value at 1 m from air inlet side
- Operating temperature Refer to specifications (Non-condensing)
- Storage temperature -30 °C to +70 °C (Non-condensing)
- Lead wire ⊕Red ⊖Black Sensor: Yellow Control: Brown
- Mass Approx. 630 g

Airflow - Static Pressure Characteristics

- PWM duty cycle

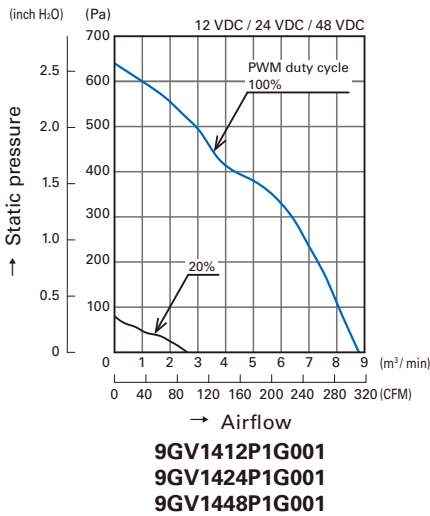

- Operating voltage range

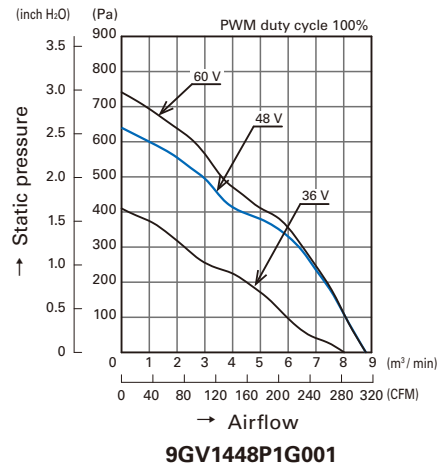
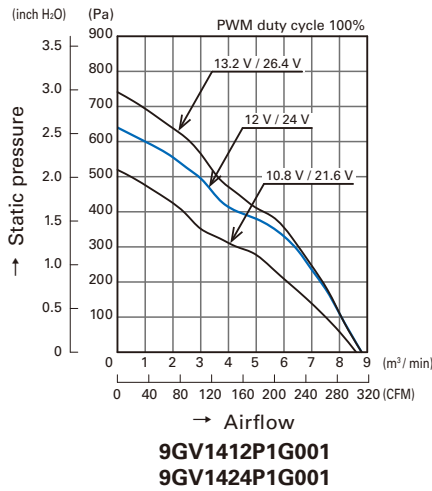

- PWM duty cycle

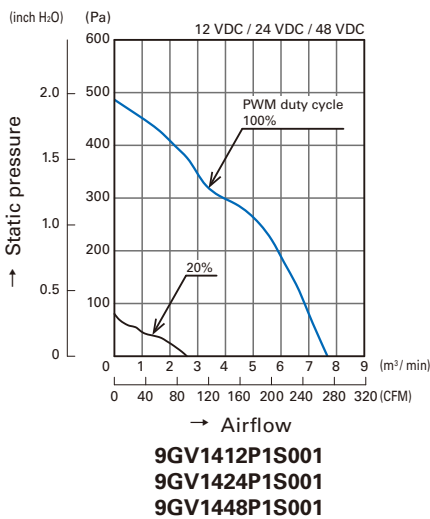

- Operating voltage range

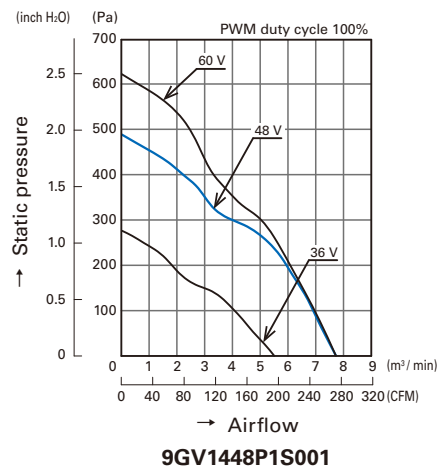
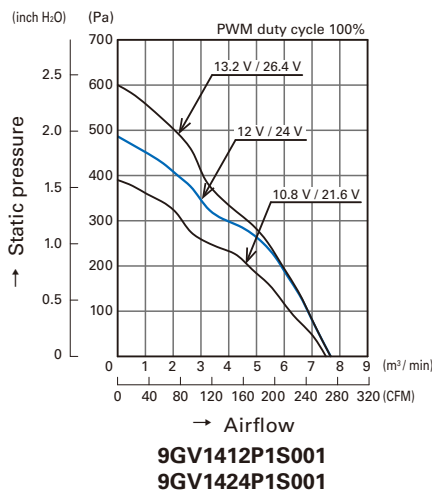

- PWM duty cycle

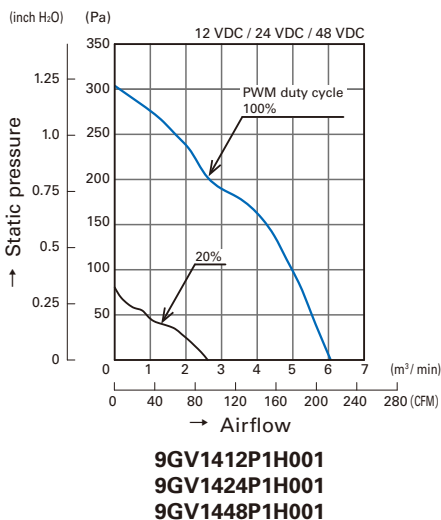

- Operating voltage range

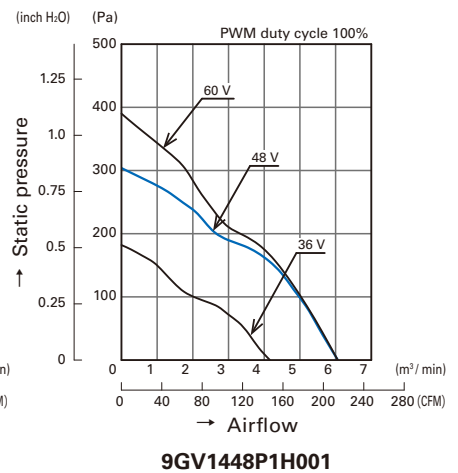
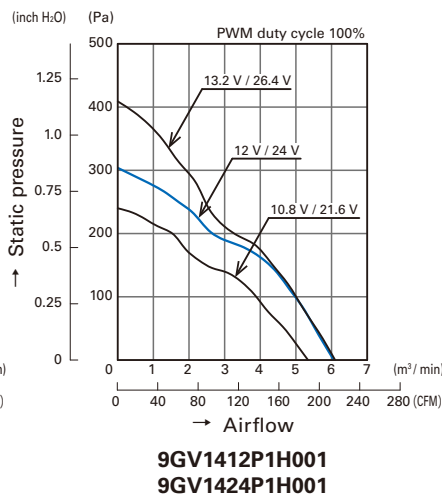

PWM Duty - Speed Characteristics Example

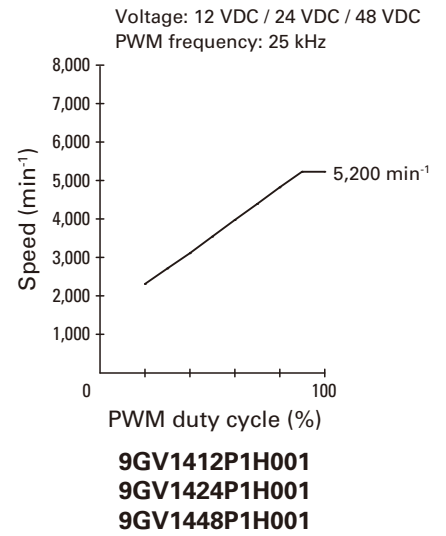
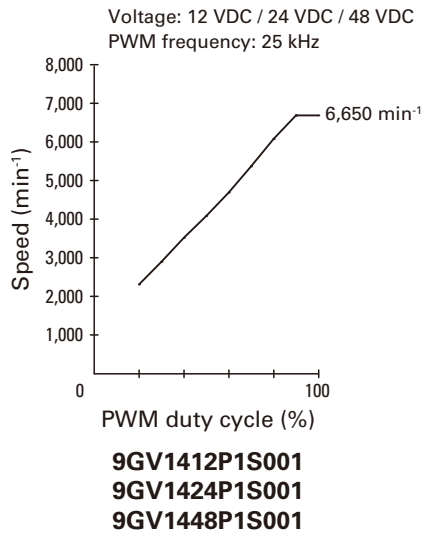
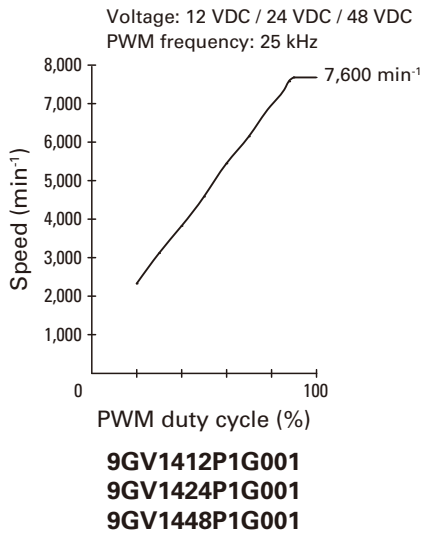

PWM Input Signal Example

Input signal waveform

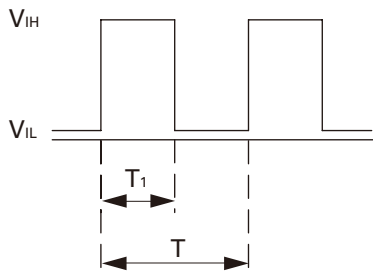

$V_{IH}=4.75\text{ V to }5.25\text{ V}$

$V_{IL}=0\text{ V to }0.4\text{ V}$

$$\text{PWM duty cycle (\%)} = \frac{T_1}{T} \times 100$$

$$\text{PWM frequency } 25\text{ (kHz)} = \frac{1}{T}$$

Source current (I_{source}) : 1 mA max. at control voltage 0 V

Sink current (I_{sink}) : 1 mA max. at control voltage 5.25 V

Control terminal voltage: 5.25 V max. (Open circuit)

When the control lead wire is open, the fan speed is the same as the one at a PWM duty cycle of 100%.

Either TTL input, open collector or open drain can be used for PWM control input signal.

Example of Connection Schematic

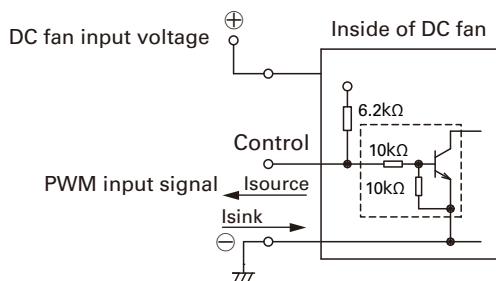

Rated voltage 12 V fan

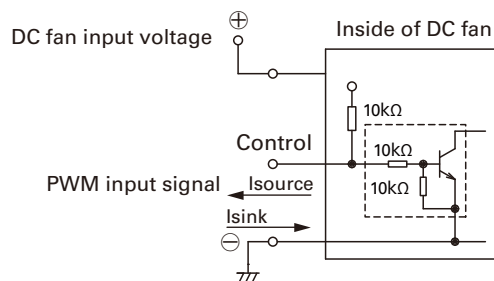

Rated voltage 24 V / 48 V fan

Specifications for Pulse Sensors

Output circuit: Open collector

Output waveform (Need pull-up resistor)
In case of steady running

Inside of DC fan

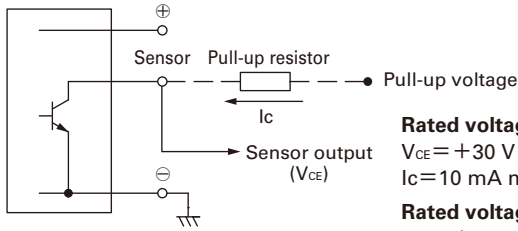

Rated voltage 12 V / 24 V fan

$V_{CE} = +30 \text{ V max.}$

$I_c = 10 \text{ mA max. } [V_{OL} = V_{CE} (\text{SAT}) = 0.6 \text{ V max.}]$

Rated voltage 48 V fan

$V_{CE} = +60 \text{ V max.}$

$I_c = 10 \text{ mA max. } [V_{OL} = V_{CE} (\text{SAT}) = 0.6 \text{ V max.}]$

(One revolution)

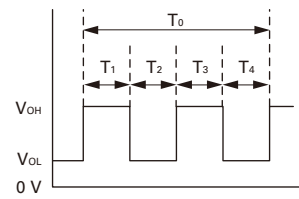

$$T_{1 \text{ to } 4} \doteq (1/4) T_0$$

$$T_{1 \text{ to } 4} \doteq (1/4) T_0 = 60/4N \text{ (sec)}$$

$$N = \text{Fan speed (min}^{-1}\text{)}$$

Dimensions (unit: mm)

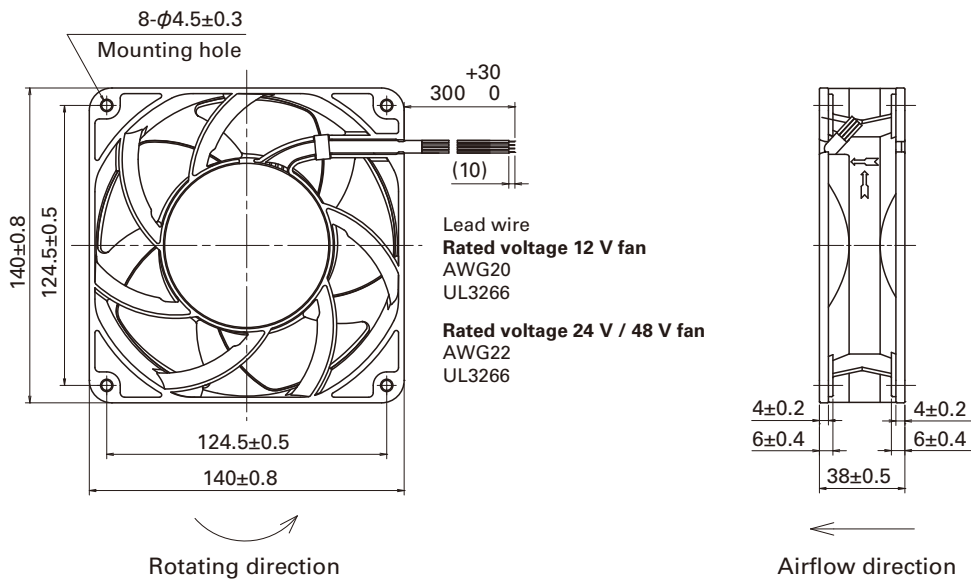

Reference Dimensions of Mounting Holes and Vent Opening (unit: mm)

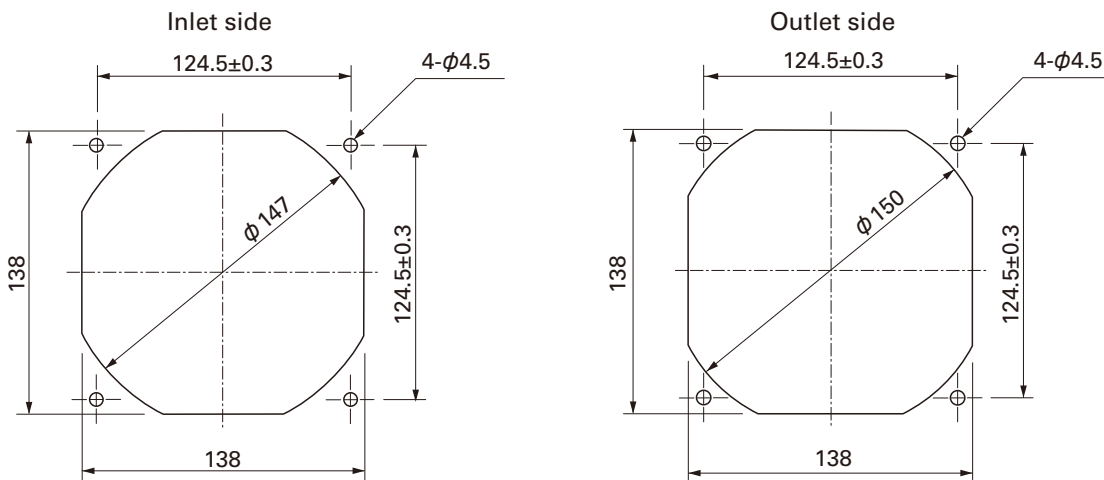

Notice

- Please read the "Safety Instructions" on our website once you have decided on a product for use.
- The products shown in this catalog are subject to Japanese Export Control Law. Diversion contrary to the law of exporting country is prohibited.
- To protect against electrolytic corrosion that may occur in locations with strong electromagnetic noise, we provide fans that are unaffected by electrolytic corrosion.

SANYO DENKI CO., LTD. 3-33-1, Minami-Otsuka, Toshima-ku, Tokyo, 170-8451, Japan TEL: +81 3 5927 1020

<http://www.sanyodenki.com>

The names of companies and/or their products specified in this catalog are the trade names, and/or trademarks and/or registered trademarks of such respective companies. "San Ace" is a trademark of SANYO DENKI CO., LTD.

Specifications are subject to change without notice.

CATALOG No. C1053B001 '15.7