

Reference Design KL25-AGMP01

User Guide

10-Axis Data Logger Tool Kit

Contents

1	Getting Started	2
1.1	Kit Contents.....	2
1.2	System Requirements.....	2
1.3	Software Requirements	2
2	Getting to Know the Hardware	3
2.1	Reference Design Overview	3
2.2	Board Features.....	3
2.3	Board Description	3
3	Setting Up the Hardware, Software and Graphical User Interface	4
3.1	Connecting the Hardware	4
3.2	Installing OpenSDA Drivers on the PC.....	4
3.3	Installing the Generic Data Logger for Sensor Data Analytics Software	5
3.4	Programming the RD-KL25-AGMP01 Board.....	6
4	Using the Generic Data Logger for Sensor Data Analytics (Generic Data Logger)	7
4.1	Starting the Generic Data Logger	7
4.2	Understanding the Generic Data Logger User Interface.....	7
4.2.1	Data Logger Area.....	8
4.2.2	Sensor Boards Area.....	9
4.2.3	Output and Control Area.....	10
4.3	Output from the Generic Data Logger Application.....	11
4.3.1	Output File Naming Convention.....	11
4.3.2	Output file contents	12
5	Applicable Parts	19
6	References	19
7	Revision History	19

Getting Started

1 Getting Started

This user guide describes the operation of the Freescale RD-KL25-AGMP01 reference design board. This kit provides hardware and software needed for data collection for up to 10 degrees of freedom using various Freescale sensors. The Data Logger software provides a simple platform to collect, log, and tag the data with user-specified metadata. For more information, refer to freescale.com/RDKL25AGMP01.

1.1 Kit Contents

The RD-KL25-AGMP01 contents include:

- Reference design board
- Lithium-ion battery (< 2 Watt hour)
- USB cable
- Quick Reference Card

1.2 System Requirements

Windows PC

- Windows® XP, Windows 7 or Windows 8
- USB port

1.3 Software Requirements

Software Component	Function/Purpose
Freescale's Generic Data Logger for Sensor Data Analytics software	Primary data collection application and GUI for the reference design board setup and use
RD-KL25-AGMP01 firmware image	Software for Kinetis KL25Z microcontroller and accessing the sensors on the board allowing communication with the host system
mbed OpenSDAv2 driver	Provides driver support for .bin file format for data collection
mbed OpenSDAv1 driver	Provides support for new software development by the user but does not support data collection
OpenSDA interface	Provides a virtual serial port and a convenient method to load applications into the Kinetis KL25Z microcontroller

2 Getting to Know the Hardware

2.1 Reference Design Overview

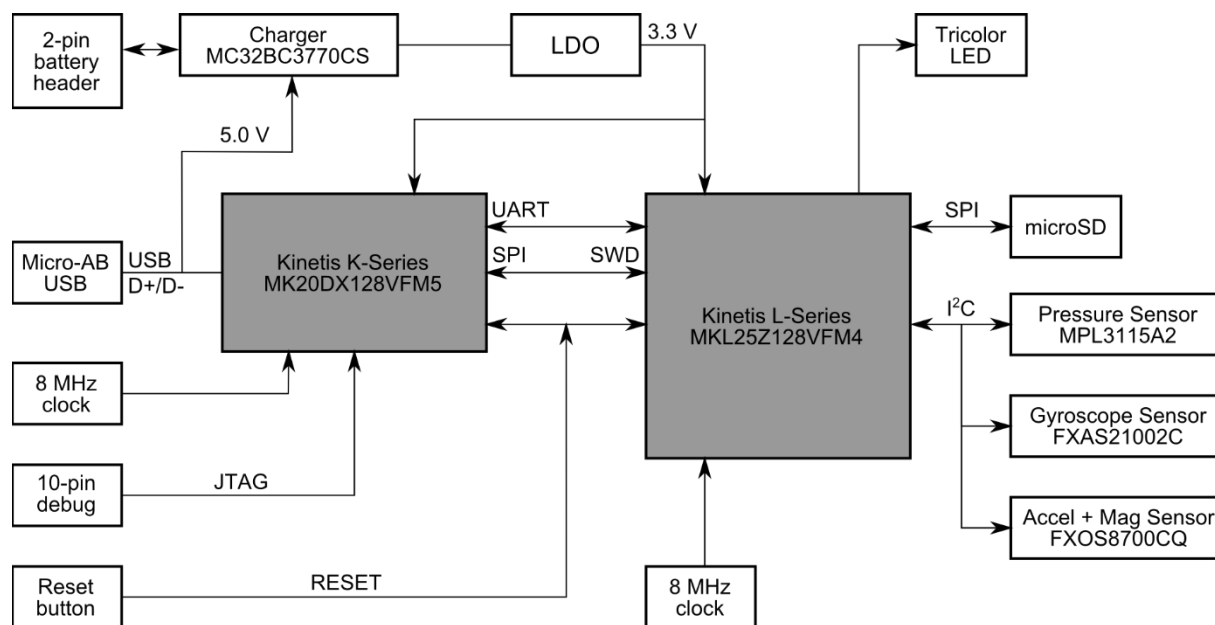

Figure 1. Block diagram for RD-KL25-AGMP01

2.2 Board Features

The RD-KL25-AGMP01 is configured with the following features.

- Small form factor of 1.2 in x 1.5 in
- Up to 10 degrees of freedom for sensor calculations
- Data collection via USB
- Data collection with microSD™ with the proper firmware enablement

2.3 Board Description

The RD-KL25-AGMP01 reference design board incorporates the following Freescale devices:

- FXOS8700CQ 6-axis e-compass
- FXAS21002C 3-axis digital angular rate gyroscope
- MPL3115A2 Precision altimeter and temperature sensor
- Kinetis KL25Z and Kinetis K20 microcontrollers
- MC32BC3770CS Li-ion battery charger

Figure 2 identifies the major components of the RD-KL25-AGMP01 reference design. For more information, visit freescale.com/RDKL25AGMP01.

Setting Up the Hardware, Software and Graphical User Interface

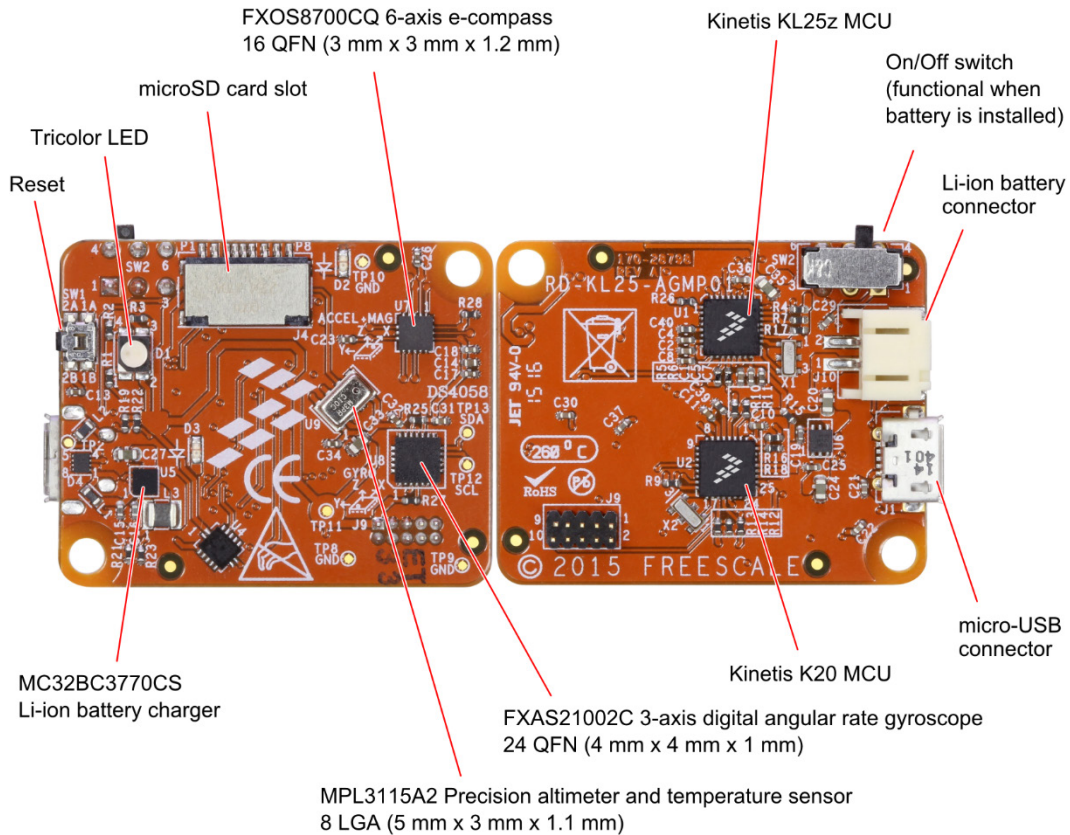

Figure 2. RD-KL25-AGMP01 board components

3 Setting Up the Hardware, Software and Graphical User Interface

To configure this reference design board and PC for use, you must:

1. Connect the hardware
2. Install mbed drivers on the PC
3. Install the Generic Data Logger for Sensor Data Analytics software
4. Program the board to ensure the latest firmware is installed (see section 3.4).

3.1 Connecting the Hardware

Connect the reference design board to the PC using the provided USB cable.

The RD-KL25Z-AGMP01 kit includes a battery, which is not required when the board is connected by USB cable. The battery can be used when USB power is not available and the data is stored onto a microSD card.

3.2 Installing OpenSDA Drivers on the PC

RD-KL25-AGMP01 comes preprogrammed with mbed OpenSDAv2, which supports .bin file format for data collection.

Setting Up the Hardware, Software and Graphical User Interface

NOTE: For customer software development using Code Warrior, OpenSDAv1 is necessary, which supports the .srec file format. For compatibility, see [Table 1](#).

Table 1. OpenSDA version information

Version	Bootloader	Default Debugging Interface	Flash Programming	Virtual Serial Port	Notes
OpenSDAv1	Proprietary	P&E Micro	.sda/.s19/.srec	Yes	Used for new software development
OpenSDAv2	ARM®/mbed™	CMSIS-DAP	.bin	Yes	Used for data collection
OpenSDAv2.1	ARM/mbed	CMSIS-DAP	.bin	Yes	Used for data collection

OpenSDA is an open standard, serial and debug adapter that bridges serial and debug communications between a USB host and an embedded target processor. OpenSDA software includes a flash-resident, USB mass-storage device (MSD) bootloader and a collection of OpenSDA applications. The RD-KL25-AGMP01 includes a MSD flash programmer OpenSDA preinstalled application. For more information, refer to freescale.com/OpenSDA.

Open SDA provides a virtual serial port and a convenient way to load applications into the KL25Z microcontroller. The MSD flash programmer emulates a FAT16 file system appearing as a removable drive with a volume label of MBED. Raw .bin or .srec files that are copied to the drive are loaded directly into the flash of the KL25Z microprocessor and executed automatically.

To install mbed drivers for this board, complete the instructions found at developer.mbed.org/handbook/Windows-serial-configuration.

NOTE: After installing the mbed drivers, the user should reboot their machine to make the drivers effective.

3.3 Installing the Generic Data Logger for Sensor Data Analytics Software

The software is provided as a prebuilt executable image file.

1. Go to freescale.com/RDKL25AGMP01, then click on the **Software and Tools** tab, and then locate and download the **Generic Data Logger for Sensor Data Analytics** software bundle.
2. Read the Freescale software license agreement and then click **I Accept**.
3. Extract the downloaded **KL25-AMP01-GEN-DATA-LOG.zip** file to a location of your choosing.

The Generic Data Logger for Sensor Data Analytics software is an executable file named *DataLogger.exe*. The *DataLogger.exe* is located in the Release folder. See [Figure 3](#).

Setting Up the Hardware, Software and Graphical User Interface

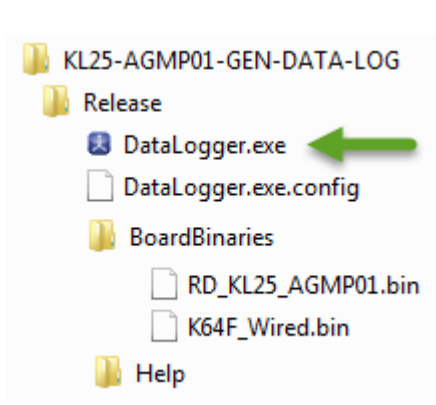

Figure 3. Contents of Generic Data Logger for Sensor Data Analytics software bundle

The Generic Data Logger for Sensor Data Analytics software is now ready to use.

3.4 Programming the RD-KL25-AGMP01 Board

The Kinetis KL25Z microcontroller is supplied preprogrammed with RD-KL25-AGMP01 firmware. To program the Kinetis KL25Z microcontroller with the latest firmware, follow these steps:

1. Connect the hardware.
2. In the **Device Manager** of the PC, verify that the PC recognizes the **MBED** portable device and the **mbed Serial Port**. See [Figure 4](#).



Figure 4. Portable devices and ports list

3. In **Windows Explorer**, verify the presence of a removable drive named **MBED**. See [Figure 5](#).

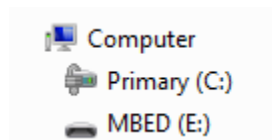

Figure 5. Removable drive named MBED

NOTE: If the removable drive named MBED is not present, the board may not be connected properly. Check the board connections.

4. Copy the sample program file named **RD_KL25_AGMP01.bin** (see [Figure 6](#)) from the RD-KL25-AGMP01 software bundle in the BoardBinaries folder to the **MBED** drive.

Using the Generic Data Logger for Sensor Data Analytics (Generic Data Logger)

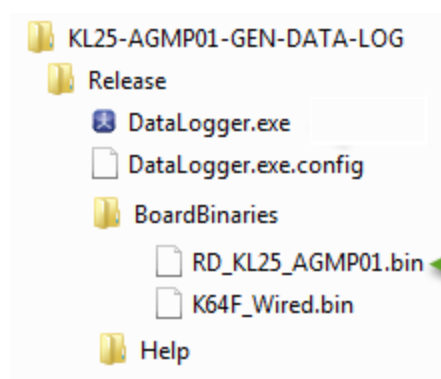

Figure 6. RD_KL25_AGMP01.bin file location

In a similar way, you can also program the board with your own .srec file developed for your particular application.

5. Power cycle the reference design board by disconnecting and then reconnecting the USB cable to the OpenSDA port.

After the firmware update is complete and the reference design board is not detecting movement or vibration, the tricolor LED is flashing. The reference design board is now ready to use with Freescale's Generic Data Logger for Sensor Data Analytics software.

4 Using the Generic Data Logger for Sensor Data Analytics (Generic Data Logger)

4.1 Starting the Generic Data Logger

1. Complete the set-up procedures described in [Setting Up the Hardware, Software and Graphical User Interface](#).
2. Open **DataLogger.exe**.

The Generic Data Logger graphical user interface (GUI) is now ready for use.

4.2 Understanding the Generic Data Logger User Interface

The Generic Data Logger main screen consists of three areas. See [Figure 7](#).

- Data Logger Area
- Sensor Boards Area
- Output and Control Area

Using the Generic Data Logger for Sensor Data Analytics (Generic Data Logger)

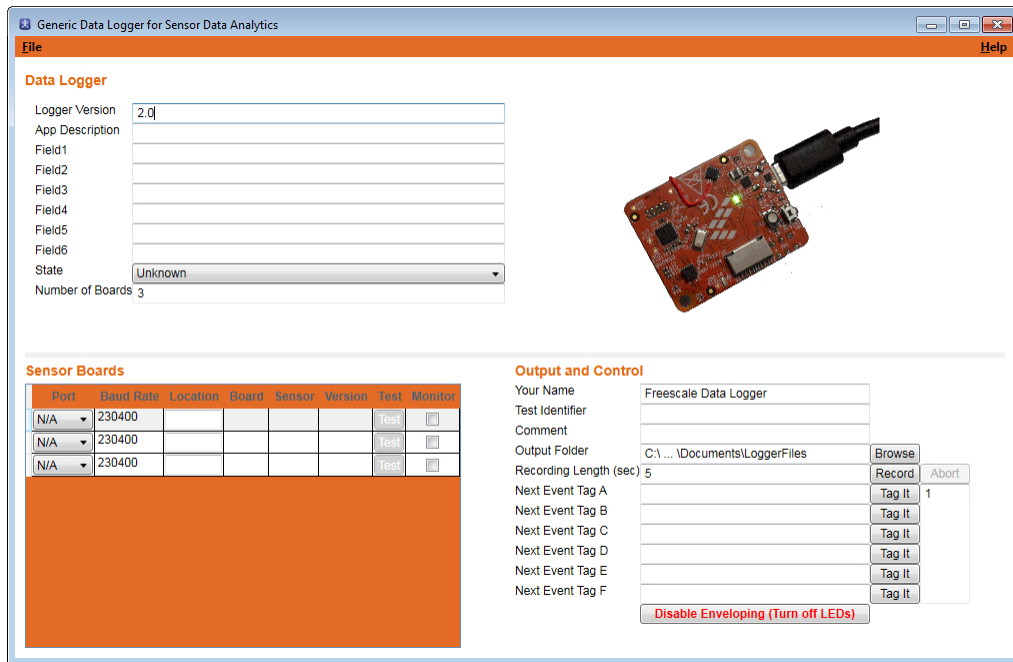

Figure 7. Generic Data Logger main screen

4.2.1 Data Logger Area

The Data Logger area defines the top-level configuration of the logger.

NOTE: All Data Logger field values are recorded in a configuration file as part of the output. For more information on the output file, see [Output from the Generic Data Logger Application](#).

Data Logger

Logger Version	2.0
App Description	
Field1	
Field2	
Field3	
Field4	
Field5	
Field6	
State	Unknown
Number of Boards	3

Using the Generic Data Logger for Sensor Data Analytics (Generic Data Logger)

Table 2. Data Logger area field descriptions

Field	Purpose	Notes
Logger Version	Reports the current version of the Generic Data Logger software	System generated.
App Description	Contains a short description of the application being logged	User entered.
Field1 through Field6	Contains app-specific metadata about the data logging session.	User entered.
Number of Boards	Number of sensor boards in use by the application.	User entered. This field value sets the number of boards listed in the Sensor Boards area of the Generic Data Logger.

4.2.2 Sensor Boards Area

Up to ten RD-KL25-AGMP01 boards can be used at the same time. The user can set the COM ports and baud rates of each connected board using the Generic Data Logger.

Sensor Boards

Port	Baud Rate	Location	Board	Sensor	Version	Test	Monitor
N/A ▼	230400					Test	<input type="checkbox"/>
N/A ▼	230400					Test	<input type="checkbox"/>
N/A ▼	230400					Test	<input type="checkbox"/>

NOTE: All Data Logger field values are recorded in a configuration file as part of the output.

Table 3. Sensor Boards area field descriptions

Field	Purpose	Notes
Port	Displays the port used by the board	User selected
Baud Rate	Indicates sensor board baud rate	The baud rate has a default value of 230400 baud, but can be changed by the user to accommodate other logger speeds.
Location	Describes the sensor location (required)	User entered
Board	Sensor board identified by the system	System generated
Sensor	Identifies the sensors in use on the board	System generated
Version	Identifies the version of Generic Data Logger software in use.	System generated
Monitor	Includes or excludes the board in the data collection session.	User selected. Whether the Monitor box is checked or unchecked, sensor board field values are recorded in the configuration file as part of the output.

NOTE: The preprogrammed baud rate of the RD-KL25-AGMP01 board is 230400 baud. The COM port and baud rate must match the COM port and baud rate of the desired board, otherwise, communication errors occur.

Using the Generic Data Logger for Sensor Data Analytics (Generic Data Logger)

Table 4. Sensor Boards area button description

Field	Purpose	Notes
Test	Verifies the board is recognized, properly connected and ready to collect data.	Performing the test on a board populates the Board, Sensor and Version fields. Note that the board LED will flash green.

4.2.3 Output and Control Area

The Output and Control area contains fields for tagging the collected data. The user-specified event tag information is entered manually in each field. All Output and Control field values are recorded in a configuration file as part of the output. For more information on the output file, see [Output from the Generic Data Logger Application](#).

Output and Control

Your Name	Freescale Data Logger	
Test Identifier		
Comment		
Output Folder	C:\... \Documents\LoggerFiles	Browse
Recording Length (sec)	5	Record Abort
Next Event Tag A		Tag It 1
Next Event Tag B		Tag It
Next Event Tag C		Tag It
Next Event Tag D		Tag It
Next Event Tag E		Tag It
Next Event Tag F		Tag It
Disable Enveloping (Turn off LEDs)		

NOTE: All Data Logger field values are recorded in a configuration file as part of the output.

Using the Generic Data Logger for Sensor Data Analytics (Generic Data Logger)

Table 5. Output and Control area field descriptions

Field	Purpose	Notes
Your Name	Field to identify user performing the data collection	User entered
Test Identifier	Label for the data collection session	User entered
Output Folder	Determines where the Generic Data Logger places the output files from the data collection session.	User entered
Recording Length (sec)	Determines the period in seconds of the current data collection session.	User entered
Next EVENT TAG A through Next EVENT TAG F	Fields to be used in labelling data during data collection events when Tag It button is selected.	User entered

Table 6. Output and Control area button descriptions

Field	Purpose	Notes
Record/Abort	Directs the software to begin collecting data.	Clicking Record results in data being collected according to the settings specified and output files are generated.
Tag It	Directs that Next Event labels (A–F) are applied during data collection.	When clicked, Generic Data Logger inserts a tag within the collected data.
Enable/Disable Enveloping (Turn on/off LEDs)	Toggles software enveloping function to reduce noise.	The enveloping function provides a visual feedback to the user. The tricolor LED (D1) blinking duty cycle and color varies inversely to the intensity of the accelerometer data. Normally, the higher the intensity, the higher the duty cycle. When the intensity passes a preset threshold, the LED stops blinking and illuminates as a solid white color.

4.3 Output from the Generic Data Logger Application

The output from the Generic Data Logger is saved as a compressed (.zip) file in the location specified in the Data Logger Output Folder field. A new output file is generated every time the user collects data.

4.3.1 Output File Naming Convention

The output file name contains a date stamp followed by the Output and Control Test Identifier field value.

NOTE: Spaces are replaced with underscores. See Figure 8.

Using the Generic Data Logger for Sensor Data Analytics (Generic Data Logger)

Output and Control



Figure 8. Data Logger output file naming

4.3.2 Output File Contents

The Generic Data Logger output contains several files; five data files per board and *configuration.xml*, as shown in Figure 9.

NOTE: Files names in Figure 9 are for illustration purposes only. Actual file names include the value of the Sensor Boards Location field.







Name	Type	Compressed size
 location_accelerometer.csv	Microsoft Excel Comma Separated Values File	25 KB
 location_gyrometer.csv	Microsoft Excel Comma Separated Values File	31 KB
 location_magnetometer.csv	Microsoft Excel Comma Separated Values File	30 KB
 location_pressure.csv	Microsoft Excel Comma Separated Values File	10 KB
 location_temperature.csv	Microsoft Excel Comma Separated Values File	17 KB
 configuration.xml	XML File	1 KB

Figure 9. Output file contents

4.3.2.1 Data Files

The output contains recorded data from the accelerometer, gyrometer, magnetometer, pressure and temperature sensors for each board, in CSV format.

- *location_accelerometer.csv*
- *location_gyrometer.csv*
- *location_magnetometer.csv*
- *location_pressure.csv*
- *location_temperature.csv*

The temperature data shown in the Data Logger output example is gathered from the internal temperature sensor in MPL3115A2.

The coordinate system used by the board is shown in Figure 10.

Using the Generic Data Logger for Sensor Data Analytics (Generic Data Logger)

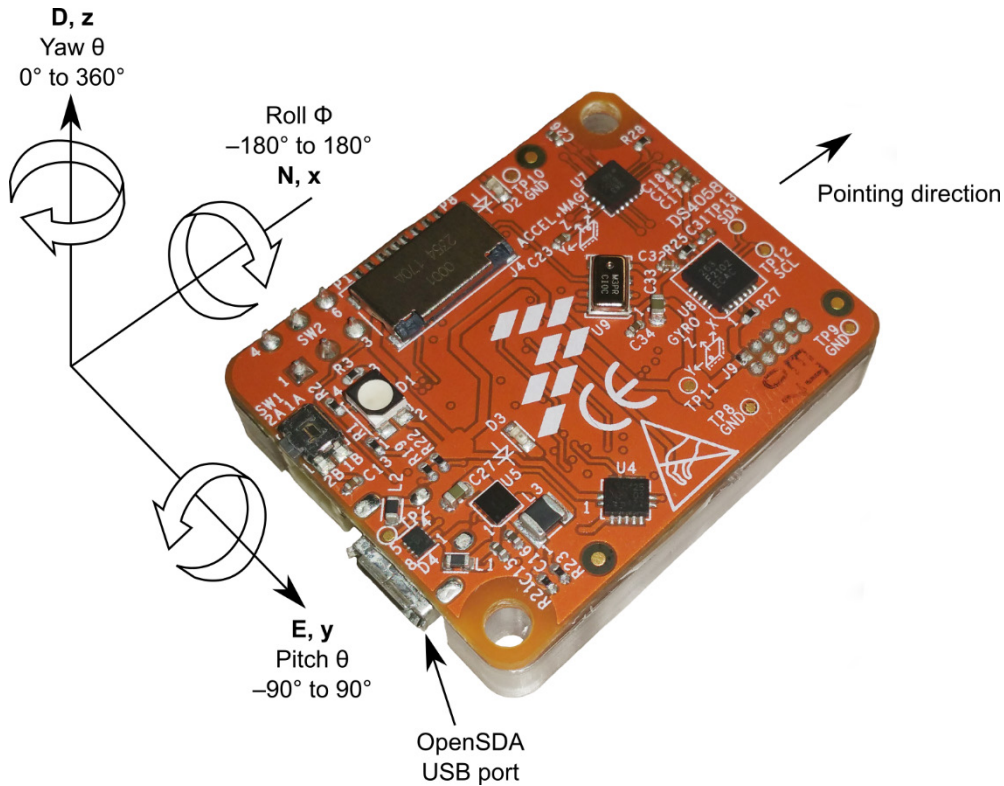

Figure 10. RD-KL25-AGMP01 coordinate system

4.3.2.2 configuration.xml

This file contains the metadata from the Data Logger setup fields. Table 5 shows the mapping of Data Logger field names to elements in *configuration.xml*.

Table 7. Data Logger field name to *configuration.xml* element mapping

Data Logger field name	<i>configuration.xml</i> element
Data Logger area	
Logger Version	<ApplicationVersion>
App Description	<ApplicationDescription>
Field1	<Field1>
Field2	<Field2>
Field3	<Field3>
Field4	<Field4>
Field5	<Field5>
Field6	<Field6>
State	<State>
Number of Boards	—
Sensor Boards area	
Port	<SensorBoards><LoggerBoard><Port>
Baud Rate	<SensorBoards><LoggerBoard><BaudRate>
Location	<SensorBoards><LoggerBoard><Location>

Using the Generic Data Logger for Sensor Data Analytics (Generic Data Logger)

Data Logger field name	<i>configuration.xml</i> element
Board	<SensorBoards><LoggerBoard><Board>
Sensor	<SensorBoards><LoggerBoard><Sensor>
Version	<SensorBoards><LoggerBoard><SW_Version>
Monitor	<SensorBoards><LoggerBoard><IsMonitored>
Test	<SensorBoards><LoggerBoard><Status>
Output and Control area	
Your Name	<TechnicianName>
Test Identifier	<TestID>
Comment	<Comment>
Output Folder	<Output_Folder>
Recording Length (sec)	<Requested_Recording_Length>
Next Event Tag A	<NextEventA>
Next Event Tag B	<NextEventB>
Next Event Tag C	<NextEventC>
Next Event Tag D	<NextEventD>
Next Event Tag E	<NextEventE>
Next Event Tag F	<NextEventF>

Using the Generic Data Logger for Sensor Data Analytics (Generic Data Logger)

Example 1. Elevator Door Activity Data Collection

This example demonstrates the *configuration.xml* file contents based on specific Generic Data Logger setup. Two sensors are positioned at right angles to each other on an elevator door frame. Using the Data Logger software, as the elevator door opens and closes, data is collected and tagged with event labels. The Generic Data Logger is set up as shown in [Figure 11](#).

Data Logger

Logger Version	2.0
App Description	50 Hz Tone
Field1	var1
Field2	var2
Field3	var3
Field4	var4
Field5	var5
Field6	var6
State	Sequence
Number of Boards	2

Sensor Boards

Port	Baud Rate	Location	Board	Sensor	Version	Test	Monitor
COM3	230400	internal	RD_KL25_AGMP01	FXOS8700, FXAS21002, MPL3115	1.0	<input type="button" value="Test"/>	<input checked="" type="checkbox"/>
COM4	230400	external	RD_KL25_AGMP01	FXOS8700, FXAS21002, MPL3115	1.0	<input type="button" value="Test"/>	<input checked="" type="checkbox"/>

Output and Control

Your Name	my_name
Test Identifier	DEMO_OUTPUT
Comment	Sensor board rubber banded to speaker
Output Folder	...data logger <input type="button" value="Browse"/>
Recording Length (sec)	15 <input type="button" value="Record"/> <input type="button" value="Abort"/>
Next Event Tag A	Tone is on <input type="button" value="Tag It"/> 1
Next Event Tag B	Tone is off <input type="button" value="Tag It"/>
Next Event Tag C	Elevator Arrives 2nd Floor <input type="button" value="Tag It"/>
Next Event Tag D	Elevator Leaves 2nd Floor <input type="button" value="Tag It"/>
Next Event Tag E	Door Opening <input type="button" value="Tag It"/>
Next Event Tag F	Door Closing <input type="button" value="Tag It"/>
<input type="button" value="Disable Enveloping (Turn off LEDs)"/>	

Figure 11. Example Data Logger setup for elevator data collection

Using the Generic Data Logger for Sensor Data Analytics (Generic Data Logger)

Upon recording a data session, the Data Logger saves the metadata in the *configuration.xml* file.

Configuration.xml

```
<?xml version="1.0" encoding="utf-8"?>
<Logger xmlns:xsi="http://www.w3.org/2001/XMLSchema-instance"
xmlns:xsd="http://www.w3.org/2001/XMLSchema">
  <TestID>DEMO_OUTPUT</TestID>
  <TechnicianName>my_name</TechnicianName>
  <Comment>Sensor board rubber banded to speaker</Comment>
  <NextEventA>Tone is on</NextEventA>
  <NextEventB>Tone is off</NextEventB>
  <NextEventC>Elevator Arrives 2nd Floor</NextEventC>
  <NextEventD>Elevator Leaves 2nd Floor</NextEventD>
  <NextEventE>Door Opening</NextEventE>
  <NextEventF>Door Closing</NextEventF>
  <Output_Folder>...\data logger</Output_Folder>
  <Timestamp>20150923090728</Timestamp>
  <Requested_Recording_Length>15</Requested_Recording_Length>
  <Actual_Recording_Length>15.553</Actual_Recording_Length>
  <SensorBoards>
    <LoggerBoard>
      <Port>COM3</Port>
      <BaudRate>230400</BaudRate>
      <IsMonitored>true</IsMonitored>
      <Status>Ok</Status>
      <Board>RD_KL25_AGMP01</Board>
      <Sensor>FXOS8700, FXAS21002, MPL3115</Sensor>
      <SW_Version>1.0</SW_Version>
      <Location>internal</Location>
    </LoggerBoard>
    <LoggerBoard>
      <Port>COM4</Port>
      <BaudRate>230400</BaudRate>
      <IsMonitored>true</IsMonitored>
      <Status>Ok</Status>
      <Board>RD_KL25_AGMP01</Board>
      <Sensor>FXOS8700, FXAS21002, MPL3115</Sensor>
      <SW_Version>1.0</SW_Version>
      <Location>external</Location>
    </LoggerBoard>
  </SensorBoards>
  <ApplicationVersion>2.0</ApplicationVersion>
  <ApplicationDescription>50 Hz Tone</ApplicationDescription>
  <Field1>var1</Field1>
  <Field2>var2</Field2>
  <Field3>var3</Field3>
  <Field4>var4</Field4>
  <Field5>var5</Field5>
  <Field6>var6</Field6>
  <State>Sequence</State>
</Logger>
```

Using the Generic Data Logger for Sensor Data Analytics (Generic Data Logger)

Sample Data Logger Sensor Data with Tagging

56304987	17312	12800	61760		
56309997	16480	12992	62016		
56314987	16000	12480	60608	1	"Tone is on"
56319998	15392	12320	60160		
56324987	15200	11872	59712		
56329995	14400	11744	59456	2	"Tone is off"
56334987	14208	12000	59264		
56339997	14720	12160	58976		
56344987	15616	12672	59008	3	"Elevator Arrives 2nd Floor"
56349998	16128	13152	59232		
56354987	17376	13728	60160		
56359995	17696	13856	61664	4	"Elevator Leaves 2nd Floor"
56364987	17120	14048	62464		
56369996	17056	14592	62816		
56374987	17472	14880	63008	5	"Door Opening"
56379998	17696	14752	63584		
56384986	17920	14464	63968		
56389995	17856	14528	63936	6	"Door Closing"

Using the Generic Data Logger for Sensor Data Analytics (Generic Data Logger)

5 Applicable Parts

This document applies to the following Freescale devices and sensors.

Device	Description
RD-KL25-AGMP01	Data Collection Reference Design with 10-axis sensing via the FXAS21002C, FXOS8700CQ, and MPL3115A2
FXOS8700CQ	6-Axis Sensor with Integrated Linear Accelerometer and Magnetometer
FXAS21002C	3-Axis Digital Angular Rate Gyroscope
MPL3115A2	20 to 110 kPa, Absolute Digital Pressure Sensor
MC32BC3770CSR2	2.0 A Switch-Mode Charger with Intelligent Power-Path for 1-Cell Li-Ion Battery
Kinetis KL25Z	Kinetis KL25, 48 MHz Cortex-M0+ Based Microcontroller with USB
Kinetis K20	Kinetis K20, Cortex-M4 up to 160KB Flash

6 References

1. Kinetis KL25 Sub-Family: 48 MHz Cortex-M0+ Based Microcontroller with USB, Document Number KL25P80M48SF0, freescale.com/files/32bit/doc/data_sheet/KL25P80M48SF0.pdf
2. FRDM-KL25Z User's Guide, freescale.com/files/32bit/doc/user_guide/FRDMKL25ZUM.zip
3. MAG3110 Three-Axis Digital Magnetometer Data Sheet, Document Number MAG3110, freescale.com/files/sensors/doc/data_sheet/MAG3110.pdf
4. FXOS8700CQ, 6-Axis Sensor with Integrated Linear Accelerometer and Magnetometer, Document Number FXOS8700CQ, freescale.com/files/sensors/doc/data_sheet/FXOS8700CQ.pdf
5. FXAS21002C, 3-Axis Digital Angular Rate Gyroscope, Document Number FXAS2100C, freescale.com/files/sensors/doc/data_sheet/FXAS21002.pdf
6. MPL3115A2, Xtrinsic MPL3115A2 I2C Precision Altimeter, Document Number MPL3115A2, freescale.com/files/sensors/doc/data_sheet/MPL3115A2.pdf
7. Sensor Data Analytics, freescale.com/applications/internet-of-things-iot/sensor-data-analytics:SENSOR-DATA-ANALYTICS
8. Freescale Sensor Data Analytics Blogs, [blogs.freescale.com/Sensor Data Analytics](http://blogs.freescale.com/Sensor%20Data%20Analytics)

7 Revision History

Rev. No.	Date	Description
1.0	9/2015	Initial public release

How to Reach Us:

Home Page:
freescale.com

Web Support:
freescale.com/support

Information in this document is provided solely to enable system and software implementers to use Freescale products. There are no express or implied copyright licenses granted hereunder to design or fabricate any integrated circuits based on the information in this document. Freescale reserves the right to make changes without further notice to any products herein.

Freescale makes no warranty, representation, or guarantee regarding the suitability of its products for any particular purpose, nor does Freescale assume any liability arising out of the application or use of any product or circuit, and specifically disclaims any and all liability, including without limitation consequential or incidental damages. "Typical" parameters that may be provided in Freescale data sheets and/or specifications can and do vary in different applications, and actual performance may vary over time. All operating parameters, including "typicals," must be validated for each customer application by customer's technical experts. Freescale does not convey any license under its patent rights nor the rights of others. Freescale sells products pursuant to standard terms and conditions of sale, which can be found at the following address: freescale.com/SalesTermsandConditions.

Freescale, Code Warrior and the Freescale logo are trademarks of Freescale Semiconductor, Inc., Reg. U.S. Pat. & Tm. Off. SD is a trademark of the SD Association.org. ARM and mbed are trademarks of ARM Limited (or its subsidiaries) in the EU and/or elsewhere. All rights reserved. All other product or service names are the property of their respective owners.

© 2015 Freescale Semiconductor, Inc.

Document Number: RDKL25AGMP01UG
Revision Rev. 1.0, 9/2015

