

## Dialight

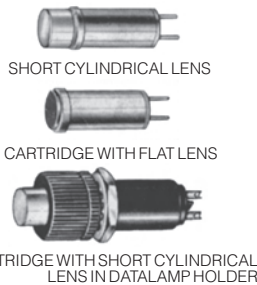

### DIALIGHT DATALITES

For data processing equipment, computers and all other applications requiring ultra miniature indicator lights. Datalites consist of (1) **Datalamp Cartridges**—a plug-in, replaceable light source; accommodated by (2) **Datalamp Holders**—made of rugged, light weight aluminum. Datalamp Cartridges consists of T-1-3/4 incandescent lamps, or neon lamps, mounted in aluminum sleeves and capped with plastic lenses. Insulated pins are offset to provide polarization. Clear anodize finish. The neon datalamp cartridges have current limiting resistors.

### DIALIGHT INCANDESCENT DATALAMP CARTRIDGES

| Cat. No.  | Colour             | Net Price |
|---|--------------------|-----------|
| <b>SHORT CYLINDRICAL LENS SHAPE</b>                     |                    |           |
| <b>14.0 VOLT, 0.080 AMP, 750 HOUR LAMP</b>              |                    |           |
| 507-3913-1471-600                                       | Translucent Red    | \$14.35   |
| 507-3913-1472-600                                       | Translucent Green  | 10.80     |
| 507-3913-1473-600                                       | Translucent Amber  | 9.18      |
| <b>SHORT CYLINDRICAL LENS SHAPE</b>                     |                    |           |
| <b>14.0 VOLT, 0.080 AMP, 50,000 HOUR LONG LIFE LAMP</b> |                    |           |
| 507-3914-1437-600                                       | Clear              | 14.41     |
| <b>SHORT CYLINDRICAL LENS SHAPE</b>                     |                    |           |
| <b>28 VOLT, 0.040 AMP, 25,000 HOUR LONG LIFE LAMP</b>   |                    |           |
| 507-3918-1431-600                                       | Transparent Red    | 8.18      |
| 507-3918-1432-600                                       | Transparent Green  | 13.57     |
| 507-3918-1433-600                                       | Transparent Amber  | 8.65      |
| 507-3918-1435-600                                       | Transparent White  | 8.18      |
| 507-3918-1437-600                                       | Clear              | 7.16      |
| 507-3918-1471-600                                       | Translucent Red    | 7.16      |
| 507-3918-1472-600                                       | Translucent Green  | 6.65      |
| 507-3918-1473-600                                       | Translucent Amber  | 7.16      |
| 507-3918-1474-600                                       | Translucent Blue   | 16.15     |
| 507-3918-1475-600                                       | Translucent White  | 7.16      |
| 507-3918-1476-600                                       | Translucent Yellow | 14.41     |
| <b>FLAT LENS SHAPE</b>                                  |                    |           |
| <b>28 VOLT, 0.040 AMP, 1000 HOUR LAMP</b>               |                    |           |
| 507-3917-0371-600*                                      | Translucent Red    | 13.63     |
| 507-3917-0372-600*                                      | Translucent Green  | 14.41     |
| 507-3917-0373-600*                                      | Translucent Amber  | 14.41     |
| 507-3917-1431-600                                       | Transparent Red    | 14.41     |
| 507-3917-1437-600                                       | Clear              | 14.41     |
| 507-3917-1471-600                                       | Translucent Red    | 7.16      |
| 507-3917-1472-600                                       | Translucent Green  | 7.16      |
| 507-3917-1473-600                                       | Translucent Amber  | 7.16      |
| 507-3917-1474-600                                       | Translucent Blue   | 14.41     |
| 507-3917-1475-600                                       | Translucent White  | 7.53      |
| 507-3917-1476-600                                       | Translucent Yellow | 14.41     |

NOTE: All the above use with 508-8738-504 cartridge.

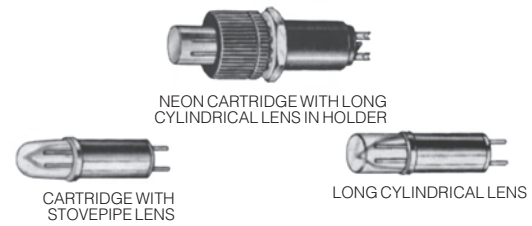

### DIALIGHT NEON DATALAMP CARTRIDGES

| Cat. No.   | Colour            | Net Price |
|--|-------------------|-----------|
| <b>STOVEPIPE LENS SHAPE, STANDARD BRIGHTNESS, WITH BUILT-IN 56K RESISTOR (FOR 105-125 VAC)</b>         |                   |           |
| 507-4537-0931-640  | Transparent Red   | \$7.98    |
| 507-4537-0933-640  | Transparent Amber | 7.53      |
| 507-4537-0937-640  | Clear             | 7.98      |
| <b>STOVEPIPE LENS SHAPE, HIGH BRIGHTNESS, WITH BUILT-IN 22K RESISTOR (FOR 105-125 VAC)</b>             |                   |           |
| 507-4538-0931-610  | Transparent Red   | 7.53      |
| 507-4538-0933-610  | Transparent Amber | 7.53      |
| 507-4538-0935-610  | Transparent White | 10.26     |
| 507-4538-0937-610  | Clear             | 10.26     |
| <b>SHORT CYLINDRICAL LENS SHAPE, STANDARD BRIGHTNESS, WITH BUILT-IN 56K RESISTOR (FOR 105-125 VAC)</b> |                   |           |
| 507-4537-1431-640  | Transparent Red   | 16.86     |
| 507-4537-1433-640  | Transparent Amber | 11.84     |
| 507-4537-1437-640  | Clear             | 19.73     |
| <b>SHORT CYLINDRICAL LENS SHAPE, HIGH BRIGHTNESS, WITH BUILT-IN 22K RESISTOR (FOR 105-125 VAC)</b>     |                   |           |
| 507-4538-1431-610  | Transparent Red   | 9.69      |
| 507-4538-1433-610  | Transparent Amber | 18.00     |
| 507-4538-1437-610  | Clear             | 16.15     |
| <b>LONG CYLINDRICAL LENS SHAPE, STANDARD BRIGHTNESS, WITH BUILT-IN 56K RESISTOR (FOR 105-125 VAC)</b>  |                   |           |
| 507-4537-1531-640  | Transparent Red   | 7.98      |
| 507-4537-1533-640  | Transparent Amber | 7.53      |
| 507-4537-1537-640  | Clear             | 16.15     |
| <b>SHORT CYLINDRICAL LENS SHAPE, HIGH BRIGHTNESS, WITH BUILT-IN 47K RESISTOR (FOR 105-125 VAC)</b>     |                   |           |
| 507-4538-1431-630  | Transparent Red   | 8.85      |
| 507-4538-1433-630  | Transparent Amber | 8.41      |
| 507-4538-1437-630  | Clear             | 8.85      |

NOTE: All the above use with 508-7545-504 or 508-8475-504 cartridges.

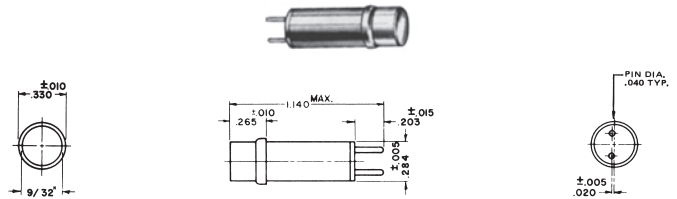

SHORT CYLINDRICAL LENS SHAPE

### DIALIGHT 507 SERIES DATALAMP CARTRIDGES WITH LED DIODE-LITES

Light source is a solid state lamp that provides the advantages of low power with extremely long life and reliability. IC compatible; interchangeable with standard incandescent cartridges. Unique lens design features an internal fresnel ring to assure maximum distribution of light output. Cartridge may be mounted with Datalamp Holder or cartridge connector with speed clip.

| Cat. No.          | Jewel Colour | Volts DC | Maximum Current mA | Net Price |
|-------------------|--------------|----------|--------------------|-----------|
| 507-4757-3331-500 | Red          | 5        | 15                 | \$5.31    |
| 507-4757-3731-500 | Red          | 5        | 15                 | 5.31      |
| 507-4759-3331-500 | Red          | 10       | 15                 | 5.31      |
| 507-4760-3331-500 | Red          | 14       | 20                 | 5.31      |
| 507-4760-3731-500 | Red          | 14       | 20                 | 5.31      |
| 507-4761-3331-500 | Red          | 28       | 15                 | 7.06      |
| 507-4857-3332-500 | Green        | 5        | 20                 | 7.20      |
| 507-4859-3332-500 | Green        | 10       | 20                 | 7.40      |
| 507-4860-3332-500 | Green        | 14       | 20                 | 7.20      |
| 507-4860-3732-500 | Green        | 14       | 20                 | 7.70      |
| 507-4861-3332-500 | Green        | 28       | 20                 | 7.20      |
| 507-4861-3732-500 | Green        | 28       | 20                 | 7.20      |
| 507-4957-3333-500 | Yellow       | 5        | 20                 | 7.20      |
| 507-4957-3733-500 | Yellow       | 5        | 20                 | 7.20      |
| 507-4960-3333-500 | Yellow       | 14       | 20                 | 7.20      |
| 507-4961-3333-500 | Yellow       | 28       | 20                 | 7.20      |
| 507-4961-3733-500 | Yellow       | 28       | 20                 | 7.20      |

NOTE: All the above use with 508-8738-504 cartridge.



515-0051

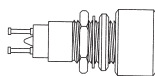

515-0074

## DATALAMP HOLDERS AND CARTRIDGES

Ultra-compact—mounts in  $\frac{3}{16}$ " clearance hole. Lamp cartridge is easily unplugged from front of panel. Collar, flange ring, and mounting bushing are aluminum with black anodize finish. The holders listed have solder cup terminals and turret terminals. 515-0051 Speed Clip: An effective fastening for use where conventional mounting is not practical. Counter-pressure of Speed Clip and flange of Cartridge secures the unit tightly against the panel. May be used with all Datalamp Cartridges. Self-retaining, dependable, vibration-proof. Made of heat-treated spring steel.

### DATALAMP HOLDERS

| Cat. No.     | Description                      | Terminals | Back Projection    | Net Price |
|--------------|----------------------------------|-----------|--------------------|-----------|
| 508-7545-504 | Cartridge for incandescent & LED | Solder    | 1 $\frac{1}{32}$ " | \$9.89    |
| 508-8745-504 | Cartridge for incandescent & LED | Turret    | 1 $\frac{1}{32}$ " | 9.42      |
| 508-8738-504 | Cartridge for neon               | Turret    | 1 $\frac{1}{8}$ "  | 8.98      |

### DATALAMP CARTRIDGE CONNECTORS

| Cat. No. | Description         | Length           | Net Price |
|----------|---------------------|------------------|-----------|
| 515-0074 | Cartridge Connector | $\frac{3}{16}$ " | \$2.98    |
| 515-0051 | Speed Clip          | —                | 1.35      |



111-8430-0111-201  
CONVEX LENS CAP



101-3830-0931-201  
STOVEPIPE LENS CAP



140-8430-1471-201  
CYLINDRICAL LENS CAP



162-8430-0931-502  
162 SERIES

## DIALIGHT $\frac{15}{32}$ " SUBMINIATURE ASSEMBLIES

Extra compact assemblies for use with T-1 $\frac{3}{4}$  incandescent bulbs ranging from 1.35 to 28 volts. Lens caps unscrew for bulb replacement from front of panel. Lamp, socket and all connections are completely insulated from bushing and panel. Mount in  $\frac{15}{32}$ " clearance hole. **3830** series assemblies mount from front or back of panel, with mounting nuts forming a moveable flange. **8430** series mount from front of panel only and have a fixed flange. All except **162** series are brass with black nickel finish. **162** series assemblies are aluminum with black anodize finish, and have anti-rotation tab on flange. Not supplied with lamp.

### FOR USE WITH T-1 $\frac{3}{4}$ MIDGET FLANGE INCANDESCENT LAMPS OR BASED LED'S

| Cat. No.  | Colour | Net Price |
|---|--------|-----------|
| <b>FRONT OR BACK INSERTION, MOVEABLE FLANGE, CONVEX LENS CAP—BACK FROSTED</b>   |        |           |
| 111-3830-0111-201   | Red    | \$23.74   |
| <b>FRONT OR BACK INSERTION, MOVEABLE FLANGE, TRANSLUCENT STOVEPIPE LENS CAP</b> |        |           |
| 101-3830-0971-201   | Red    | 13.14     |
| 101-3830-0973-201   | Green  | 29.01     |
| 101-3830-0975-201   | White  | 14.21     |

### FOR USE WITH T-1 $\frac{3}{4}$ MIDGET FLANGE INCANDESCENT LAMPS OR BASED LED'S (CONTINUED)

| Cat. No.  | Colour | Net Price |
|---|--------|-----------|
| <b>FRONT OR BACK INSERTION, MOVEABLE FLANGE, TRANSPARENT STOVEPIPE LENS CAP</b>   |        |           |
| 101-3830-0931-201   | Red    | \$14.21   |
| 101-3830-0932-201   | Green  | 50.40     |
| 101-3830-0933-201   | Yellow | 12.16     |
| 101-3830-0935-201   | White  | 14.58     |
| <b>FRONT OR BACK INSERTION, MOVEABLE FLANGE, TRANSLUCENT CYLINDRICAL LENS CAP</b> |        |           |
| 140-3830-1471-201   | Red    | 29.01     |
| 140-3830-1472-201   | Green  | 52.26     |
| 140-3830-1473-201   | Yellow | 16.25     |
| 140-3830-1475-201   | White  | 10.43     |
| <b>FRONT OF PANEL INSERTION, FIXED FLANGE, CONVEX LENS CAP—BACK FROSTED</b>       |        |           |
| 111-8430-0111-201   | Red    | 14.93     |
| <b>FRONT OF PANEL INSERTION, FIXED FLANGE, TRANSLUCENT STOVEPIPE LENS CAP</b>     |        |           |
| 101-8430-0931-201   | Red    | 26.39     |
| 101-8430-0932-201   | Green  | 26.39     |
| 101-8430-0933-201   | Yellow | 11.97     |
| <b>FRONT OF PANEL INSERTION, FIXED FLANGE, TRANSLUCENT CYLINDRICAL LENS CAP</b>   |        |           |
| 140-8430-1471-201   | Red    | 11.77     |
| 140-8430-1472-201   | Green  | 14.87     |
| 140-8430-1473-201   | Yellow | 16.06     |
| 140-8430-1474-201   | Blue   | 16.06     |
| 140-8430-1475-201   | Yellow | 15.70     |
| <b>FRONT OF PANEL INSERTION, FIXED FLANGE, TRANSLUCENT STOVEPIPE LENS CAP</b>     |        |           |
| 162-8430-0971-502   | Red    | 46.40     |
| 162-8430-0972-502   | Green  | 26.00     |
| 162-8430-0973-502   | Yellow | 20.76     |
| <b>FRONT OF PANEL INSERTION, FIXED FLANGE, TRANSPARENT STOVEPIPE LENS CAP</b>     |        |           |
| 162-8430-0931-502   | Red    | 15.16     |
| 162-8430-0932-502   | Green  | 15.16     |
| 162-8430-0933-502   | Yellow | 18.10     |
| 162-8430-0935-502   | White  | 21.72     |
| 162-8430-0937-502   | Clear  | 18.94     |
| <b>FRONT OF PANEL INSERTION, FIXED FLANGE, TRANSLUCENT CYLINDRICAL LENS CAP</b>   |        |           |
| 162-8430-1471-502   | Red    | 22.49     |
| 162-8430-1472-502   | Green  | 22.91     |
| 162-8430-1473-502   | Yellow | 22.91     |
| <b>FRONT OF PANEL INSERTION, FIXED FLANGE, TRANSPARENT CYLINDRICAL LENS CAP</b>   |        |           |
| 162-8430-1431-502   | Red    | 22.91     |



## DIALIGHT $\frac{15}{32}$ " NEON DATALAMPS

For use with T-2 neon glow lamps and C7A (NE-2D) neon lamps, standard brightness 105-125 VAC.

| Cat. No.  | Colour | Net Price |
|---|--------|-----------|
| <b>FRONT OF PANEL INSERTION, FIXED FLANGE, TRANSPARENT STOVEPIPE LENS</b> |        |           |
| 137-8836-0931-552   | Red    | \$23.89   |
| 137-8836-0933-552   | Yellow | 23.89     |
| 137-8836-0935-552   | White  | 44.70     |
| 137-8836-0937-552   | Clear  | 44.24     |



## DIALIGHT 17/32" SUBMINIATURE ASSEMBLIES

For use with T-1-3/4 midget flange incandescent lamps, or based LED's. Front of panel insertion, moveable flange.

| Cat. No.                              | Colour | Net Price |
|---------------------------------------|--------|-----------|
| <b>TRANSPARENT STOVEPIPE LENS CAP</b> |        |           |
| 101-5030-0931-201                     | Red    | \$14.87   |
| 101-5030-0932-201                     | Green  | 13.69     |
| 101-5030-0933-201                     | Amber  | 13.69     |
| 101-5030-0935-201                     | White  | 18.00     |
| <b>TRANSLUCENT STOVEPIPE LENS CAP</b> |        |           |
| 101-5030-0971-201                     | Red    | 13.80     |
| 101-5030-0973-201                     | Amber  | 14.87     |
| 101-5030-0972-201                     | Green  | 14.87     |



135-0408-1431-142  
135-0410-1431-102  
CYLINDRICAL LENS CAP

## DIALIGHT 1/16" ENCLOSED ASSEMBLIES FOR NEON LAMPS

This series accommodates rugged, long life standard brightness B1A (NE-51) or high brightness B2A (NE-51H) neon glow lamps. The necessary current-limiting resistor is built-in, as an integral part of these assemblies. All types mount in a 1/16" clearance hole. The lens cap affords a 180° light spread for maximum visibility. White nickel finish mounting bushing and lens holder, cadmium iridite finish steel mounting nut and lockwasher. Not supplied with lamp. U/L and CSA listed.

### BUILT-IN 56K RESISTOR FOR USE WITH B1A (NE-51) NEON LAMPS 105-125V AC-DC

| Cat. No.  | Colour | Net Price |
|---|--------|-----------|
| <b>SCREW-IN FLUTED STOVEPIPE LENS CAP, SOLDER TERMINALS</b>       |        |           |
| 52-0408-0991-142  | Red    | \$15.06   |
| 52-0408-0995-142  | White  | 18.00     |
| <b>SCREW-IN TRANSPARENT CYLINDRICAL LENS CAP, SCREW TERMINALS</b> |        |           |
| 135-1308-1435-142   | White  | 15.83     |
| 135-1308-1437-142   | Clear  | 14.85     |

NOTE: Green jewels not recommended with neon lamps.

### BUILT-IN 22K RESISTOR FOR USE WITH B2A (NE-51H) NEON LAMPS 110-125V AC-DC

| Cat. No.   | Colour | Net Price |
|--|--------|-----------|
| <b>SCREW-IN TRANSPARENT STOVEPIPE LENS CAP, SOLDER TERMINALS</b>   |        |           |
| 95-0463-0931-112   | Red    | \$13.21   |
| 95-0463-0933-112   | Amber  | 12.27     |
| 95-0463-0935-112   | White  | 18.25     |
| <b>SCREW-IN TRANSPARENT CYLINDRICAL LENS CAP, SOLDER TERMINALS</b> |        |           |
| 135-0463-1431-112  | Red    | 17.17     |
| 135-0463-1433-112  | Amber  | 13.30     |
| <b>SCREW-IN TRANSPARENT STOVEPIPE LENS CAP, SCREW TERMINALS</b>    |        |           |
| 95-1363-0931-112   | Red    | 28.48     |
| <b>SCREW-IN TRANSPARENT CYLINDRICAL LENS CAP, SCREW TERMINALS</b>  |        |           |
| 135-1363-1431-112  | Red    | 27.70     |
| 135-1363-1433-112  | Amber  | 28.57     |
| 135-1363-1437-112  | Clear  | 28.19     |

NOTE: Green jewels not recommended with neon lamps.



81-0410-0111-102  
CONVEX LENS CAP

## DIALIGHT 1/16" ENCLOSED ASSEMBLIES FOR INCANDESCENT LAMPS OR BASED LED'S

Indicator lights for T-3/4 bulb with miniature bayonet base. For mounting in 1/16" clearance hole. The lens cap affords a 180° light spread for maximum visibility. White nickel finish mounting bushing and lens holder; iridite finish steel mounting nut and lockwasher. Lamp not supplied.

### FOR USE WITH T-3/4 MINIATURE BAYONET INCANDESCENT LAMPS

| Cat. No.   | Colour | Net Price |
|--|--------|-----------|
| <b>SCREW-IN TRANSPARENT STOVEPIPE LENS CAP, SOLDER TERMINALS</b>   |        |           |
| 95-0410-0931-102   | Red    | \$10.78   |
| 95-0410-0932-102   | Green  | 10.78     |
| 95-0410-0935-102   | Amber  | 10.97     |
| <b>SCREW-IN TRANSPARENT CYLINDRICAL LENS CAP, SOLDER TERMINALS</b> |        |           |
| 135-0410-1431-102  | Red    | 9.99      |
| 135-0410-1432-102  | Green  | 10.87     |
| 135-0410-1433-102  | Amber  | 9.29      |
| 135-0410-1435-102  | White  | 9.57      |
| <b>SCREW-IN TRANSLUCENT CYLINDRICAL LENS CAP, SOLDER TERMINALS</b> |        |           |
| 135-0410-1472-102  | Green  | 10.87     |
| 135-0410-1475-102  | Red    | 10.87     |
| <b>SCREW-IN TRANSPARENT STOVEPIPE LENS CAP, SCREW TERMINALS</b>    |        |           |
| 95-1310-0931-102   | Red    | 20.35     |
| 95-1310-0932-102   | Green  | 20.35     |
| 95-1310-0933-102   | Amber  | 20.35     |
| 95-1310-0935-102   | White  | 20.60     |
| <b>SCREW-IN FLUTED STOVEPIPE LENS CAP, SCREW TERMINALS</b>         |        |           |
| 52-1310-0991-102   | Red    | 20.40     |
| 52-1310-0992-102   | Green  | 21.11     |
| 52-1310-0993-102   | Amber  | 20.40     |
| <b>SCREW-IN TRANSPARENT CYLINDRICAL LENS CAP, SCREW TERMINALS</b>  |        |           |
| 135-1310-1431-102  | Red    | 20.69     |
| 135-1310-1432-102  | Green  | 20.69     |
| 135-1310-1433-102  | Amber  | 20.44     |
| 135-1310-1435-102  | White  | 20.00     |
| 135-1310-1437-102  | Clear  | 20.06     |
| <b>SCREW-IN TRANSLUCENT CYLINDRICAL LENS CAP, SCREW TERMINALS</b>  |        |           |
| 135-1310-1472-102  | Green  | 20.44     |
| 135-1310-1473-102  | Amber  | 20.44     |
| 135-1310-1475-102  | White  | 20.44     |
| <b>SCREW-IN CONVEX LENS CAP—BACK FROSTED, SOLDER TERMINALS</b>     |        |           |
| 81-0410-0111-102   | Red    | 3.27      |
| 81-0410-0112-102   | Green  | 15.00     |
| 81-0410-0113-102   | Amber  | 12.09     |
| <b>SCREW-IN FACETED LENS CAP—UNFROSTED, SOLDER TERMINALS</b>       |        |           |
| 81-0410-0431-102   | Red    | 15.00     |
| 81-0410-0432-102   | Green  | 15.00     |
| 81-0410-0433-102   | Amber  | 15.00     |



Part's indicated with a leaf  are considered RoHS July 2006 compliant based on the manufacturer's confirmation at the time of publishing. For additional information please contact Electro Sonic.



125-0410-1111-403  
STOVEPIPE LENS



103-3502-1331-403  
TORPEDO FACETED LENS

## DIALIGHT 1" OIL-TIGHT ASSEMBLIES

Rugged, designed for severe vibration conditions. Oil-tight, water-tight, dust-tight. Retained oil-proof elastomer "O" ring seal construction; high impact phenolic insulation. Mounts in 1" clearance hole. Caps unscrew from front of panel; give 180° light spread. Solid brass knurled lens holder, satin chrome finish. Unfrosted dome lenses are recommended as most suitable for neon lamps. Screw terminals. Lamp not supplied. U/L and CSA listed. 1/16" Oil-Tight Assemblies: Same features and high resistance to shock and vibration as 1" Oil-Tight Series. Mounts in 1/16" clearance hole. Satin chrome is standard finish on lens holder. Assemblies for use with B1A (NE-51) neon lamps have built-in resistor. Solder terminals. Lamp not supplied.

### DIALIGHT 1" OIL TIGHT ASSEMBLIES, SCREW TERMINALS

| Cat. No.  | Colour | Net Price |
|---|--------|-----------|
| <b>DOME LENS BACK FROSTED, FOR USE WITH T-4-1/2 CANDELABRA SCREW NEON LAMPS</b>               |        |           |
| 103-3114-1211-403   | Red    | \$65.40   |
| <b>DOME LENS BACK FROSTED, FOR USE WITH S-6 CANDELABRA SCREW INCANDESCENT LAMPS</b>           |        |           |
| 103-3101-1213-403   | Amber  | 43.70     |
| <b>DOME LENS BACK FROSTED, FOR USE WITH S-6 CANDELABRA D.C. BAYONET INCANDESCENT LAMPS</b>    |        |           |
| 103-3502-1211-403   | Red    | 89.98     |
| 103-3502-1212-403   | Green  | 148.03    |
| 103-3502-1213-403   | Amber  | 43.45     |
| <b>DOME LENS UNFROSTED, FOR USE WITH T-4-1/2 CANDELABRA NEON LAMPS</b>                        |        |           |
| 103-3114-1231-403   | Red    | 56.23     |
| 103-3114-1235-403   | White  | 56.89     |
| 103-3114-1237-403   | Clear  | 57.68     |
| <b>DOME LENS UNFROSTED, FOR USE WITH S-6 CANDELABRA SCREW INCANDESCENT LAMPS</b>              |        |           |
| 103-3101-1231-403   | Red    | 137.03    |
| 103-3101-1232-403   | Green  | 138.70    |
| 103-3101-1233-403   | Amber  | 138.70    |
| 103-3101-1235-403   | White  | 138.70    |
| 103-3101-1237-403   | Clear  | 138.70    |
| <b>DOME LENS UNFROSTED, FOR USE WITH S-6 CANDELABRA D.C. BAYONET INCANDESCENT LAMPS</b>       |        |           |
| 103-3502-1231-403   | Red    | 33.02     |
| 103-3502-1232-403   | Green  | 42.19     |
| 103-3502-1233-403   | Amber  | 35.22     |
| 103-3502-1235-403   | White  | 33.68     |
| <b>FACETED TORPEDO UNFROSTED, FOR USE WITH T-4-1/2 CANDELABRA SCREW NEON LAMPS</b>            |        |           |
| 103-3114-1331-403   | Red    | 56.23     |
| 103-3114-1333-403   | Amber  | 65.40     |
| 103-3114-1335-403   | White  | 66.66     |
| <b>FACETED TORPEDO UNFROSTED, FOR USE WITH S-6 CANDELABRA SCREW INCANDESCENT LAMPS</b>        |        |           |
| 103-3101-1331-403   | Red    | 33.27     |
| 103-3101-1332-403   | Green  | 34.72     |
| 103-3101-1333-403   | Amber  | 42.44     |
| 103-3101-1335-403   | White  | 43.70     |
| <b>FACETED TORPEDO UNFROSTED, FOR USE WITH S-6 CANDELABRA D.C. BAYONET INCANDESCENT LAMPS</b> |        |           |
| 103-3502-1331-403   | Red    | 114.79    |
| 103-3502-1332-403   | Green  | 34.47     |
| 103-3502-1333-403   | Amber  | 42.19     |
| 103-3502-1335-403   | White  | 43.45     |
| 103-3502-1337-403   | Clear  | 41.36     |

## DIALIGHT 11/16" OIL TIGHT ASSEMBLIES, SOLDER TERMINALS

| Cat. No.  | Colour | Net Price |
|---|--------|-----------|
| <b>STOVEPIPE BACK FROSTED, BUILT-IN 56K RESISTOR FOR USE WITH B1A (NE-51) NEON LAMPS 105-125V AC-DC</b> |        |           |
| 125-0408-1111-443   | Red    | \$30.33   |
| 125-0408-1113-443   | Amber  | 32.66     |
| <b>STOVEPIPE BACK FROSTED, FOR USE WITH T-3-1/4 MINIATURE BAYONET INCANDESCENT LAMPS</b>                |        |           |
| 125-0410-1111-403   | Red    | 81.19     |
| <b>STOVEPIPE UNFROSTED, BUILT-IN 56K RESISTOR FOR USE WITH B1A (NE-51) NEON LAMPS 105-125V AC-DC</b>    |        |           |
| 125-0408-1133-443   | Amber  | 26.57     |
| 125-0408-1135-443   | White  | 26.25     |
| <b>STOVEPIPE UNFROSTED, FOR USE WITH T-3-1/4 MINIATURE BAYONET INCANDESCENT LAMPS</b>                   |        |           |
| 125-0410-1133-403   | Amber  | 27.60     |
| 125-0410-1135-403   | White  | 23.52     |
| 125-0410-1137-403   | Clear  | 20.81     |
| <b>STOVEPIPE INSIDE FLUTED, FOR USE WITH T-3-1/4 MINIATURE BAYONET INCANDESCENT LAMPS</b>               |        |           |
| 125-0410-1191-403   | Red    | 20.81     |



## DIALIGHT LAMP INSTALLERS

For fast and simple removal and installation of lamps used in pilot light assemblies. Two sizes are available to accommodate the most popular types of Incandescent and Neon lamps. Promotes speed on the production line without hazard to hands from broken bulbs. Indispensable for hard to reach places. Will not damage lamps. Made of high-grade rubber.

| Cat. No. | Fits Bulb Sizes   | Net Price |
|----------|-------------------|-----------|
| 506-0073 | T-3/4 and S-6     | \$2.70    |
| 506-0045 | T-3/4 and T-4 1/2 | 8.82      |



81-0431-100  
FACETED



135-1431  
CYLINDRICAL



95-0931  
STOVEPIPE

## DIALIGHT 11/16" SCREW-IN LENS CAP ASSEMBLIES FOR PANEL MOUNTING

For use with separately mounted lamp sockets. 81 Series have white nickel finish. These lens caps have a 1/16"-27 thd. shank which screws into a 505-8112-102 Bushing Assembly. The Bushing Assembly mounts in a 1/16" clearance hole, has a shank length of 3/8", and is complete with nut and lock-washer. Lens caps are identical to those on Dialight 1/16" Enclosed Assemblies shown elsewhere in this listing.

| Cat. No.                            | Colour | Lens Diam. | Net Price |
|-------------------------------------|--------|------------|-----------|
| <b>TRANSPARENT STOVEPIPE LENS</b>   |        |            |           |
| 95-0931*                            | Red    | 5/8"       | \$1.76    |
| <b>TRANSPARENT CYLINDRICAL LENS</b> |        |            |           |
| 135-1431*                           | Red    | 5/8"       | .97       |
| <b>CONVEX LENS, BACK FROSTED</b>    |        |            |           |
| 81-0111-100                         | Red    | 5/8"       | 3.27      |
| 81-0112-100                         | Green  | 5/8"       | 3.47      |
| <b>FACETED LENS, UNFROSTED</b>      |        |            |           |
| 81-0431-100                         | Red    | 5/8"       | 3.47      |
| 81-0432-100                         | Green  | 5/8"       | 3.47      |
| 81-0433-100                         | Amber  | 5/8"       | 3.69      |
| 81-0434-100                         | Blue   | 5/8"       | 3.91      |
| 81-0435-100                         | White  | 5/8"       | 3.91      |

\*NOTE: Other colours available: green (2), amber (3), blue (4), white (5), yellow (6), and clear (7). Replace the last digit with the corresponding number.



## INCANDESCENT PANEL MOUNT ASSEMBLIES

Incandescent panel mount assemblies are available as off the shelf items in 6V, 12V and 28V packages, and are available in other voltages as standard variations. Assemblies are available in a variety of colours, and lens styles, along with your choice of wire leads or quick connect terminals.

## NEON PANEL MOUNT ASSEMBLIES

Neon panel mount assemblies are available as off the shelf items in 125V and 250V packages, and are available in other voltages as standard variations. Assemblies are available in a variety of colours, and lens styles, along with your choice of wire leads or quick connect terminals. All CML neon lamp assemblies are UL and CSA approved.

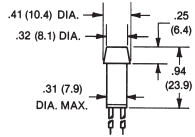

### SERIES 2990D

One-piece lens-body 6, 12 and 28 volt incandescent pilot lights. Current ratings for 2990D series: 6V-.200A, 12V-.100A, 28V-.040A.

#### GLO-DOT SERIES 2990D INCANDESCENT PILOT LIGHTS

| Cat. No.       | Lens Colour | Net Price |
|----------------|-------------|-----------|
| <b>6 VOLT</b>  |             |           |
| 2990D1-6V      | Red         | \$5.99    |
| 2990D3-6V      | Amber       | 5.99      |
| 2990D4-6V      | White       | 5.99      |
| 2990D5-6V      | Green       | 5.99      |
| 2990D6-6V      | Blue        | 5.99      |
| <b>12 VOLT</b> |             |           |
| 2990D1-12V     | Red         | 6.33      |
| 2990D3-12V     | Amber       | 6.33      |
| 2990D4-12V     | White       | 5.99      |
| 2990D5-12V     | Green       | 6.33      |
| 2990D6-12V     | Blue        | 5.99      |
| <b>26 VOLT</b> |             |           |
| 2990D1-28V     | Red         | 5.99      |
| 2990D3-28V     | Amber       | 6.33      |
| 2990D4-28V     | White       | 5.99      |
| 2990D5-28V     | Green       | 5.99      |
| 2990D6-28V     | Blue        | 5.99      |

Mounting Hole— $\frac{5}{16}$ " Diameter. Supplied with Push-On Speednut.

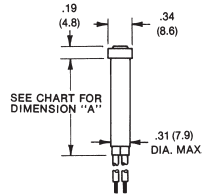

#### DIMENSION "A"

- $1\frac{3}{64}$ "—for 120 VAC (2110 & 2112 series)
- $\frac{47}{64}$ "—for 12, 28V (2195 series)

#### GLO-DOT MINIATURE INCANDESCENT PILOT LIGHTS—SERIES 2195A

| Cat. No.       | Lens Colour | Dim. "A"  | Net Price |
|----------------|-------------|-----------|-----------|
| <b>12 VOLT</b> |             |           |           |
| 2195A1-12V     | Red         | .74(18.8) | \$6.36    |
| 2195A3-12V     | Amber       | .74(18.8) | 6.36      |
| 2195A4-12V     | White       | .74(18.8) | 6.02      |
| 2195A5-12V     | Green       | .74(18.8) | 6.36      |
| <b>28 VOLT</b> |             |           |           |
| 2195A1-28V     | Red         | .74(18.8) | 6.02      |
| 2195A3-28V     | Amber       | .74(18.8) | 6.36      |
| 2195A4-28V     | White       | .74(18.8) | 6.02      |
| 2195A5-28V     | Green       | .74(18.8) | 6.36      |

#### GLO-DOT MINIATURE NEON PILOT LIGHTS—SERIES 2110A AND 2112A 120 VAC

| Cat. No. | Lens Colour | Net Price |
|----------|-------------|-----------|
| 2110A1   | Red         | \$4.71    |
| 2110A2   | Clear       | 4.71      |
| 2110A3   | Amber       | 4.71      |
| 2110A4   | White       | 4.71      |
| 2112A5   | Green       | 7.08      |
| 2112A6   | Blue        | 7.08      |

Mounting Hole— $\frac{5}{16}$ " Diameter. Supplied with Push-On Speednut.

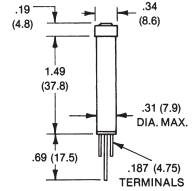

#### GLO-DOT MINIATURE NEON PILOT LIGHTS—SERIES 2110QA AND 2112QA WITH .187" TERMINALS 120 VAC

| Cat. No. | Lens Colour | Net Price |
|----------|-------------|-----------|
| 2110QA1  | Red         | \$5.08    |
| 2110QA2  | Clear       | 5.08      |
| 2110QA3  | Amber       | 5.08      |
| 2110QA4  | White       | 5.08      |
| 2112QA5  | Green       | 7.51      |

Mounting Hole— $\frac{5}{16}$ " Diameter. Supplied with Push-On Speednut.

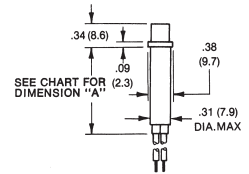

- DIMENSION "A"
- $1\frac{19}{64}$ "—for 120 VAC
  - $\frac{53}{64}$ "—for 12, 28V

#### GLO-DOT MINIATURE INCANDESCENT PILOT LIGHTS—SERIES 2194A

| Cat. No.       | Lens Colour | Dim. "A"   | Net Price |
|----------------|-------------|------------|-----------|
| <b>12 VOLT</b> |             |            |           |
| 2194A1-12V     | Red         | .83 (21.1) | \$6.73    |
| 2194A3-12V     | Amber       | .83 (21.1) | 6.73      |
| 2194A4-12V     | White       | .83 (21.1) | 6.36      |
| 2194A5-12V     | Green       | .83 (21.1) | 6.73      |
| <b>28 VOLT</b> |             |            |           |
| 2194A1-28V     | Red         | .83 (21.1) | 6.73      |
| 2194A3-28V     | Amber       | .83 (21.1) | 6.36      |
| 2194A4-28V     | White       | .83 (21.1) | 6.36      |
| 2194A5-28V     | Green       | .83 (21.1) | 6.73      |

#### GLO-DOT MINIATURE NEON PILOT LIGHTS—SERIES 2150A AND 2152A

| Cat. No. | Lens Colour | Dim. "A"   | Net Price |
|----------|-------------|------------|-----------|
| 2150A1   | Red         | .83 (21.1) | \$5.02    |
| 2150A2   | Clear       | .83 (21.1) | 5.02      |
| 2150A3   | Amber       | .83 (21.1) | 5.02      |
| 2150A4   | White       | .83 (21.1) | 5.02      |
| 2152A5   | Green       | .83 (21.1) | 8.04      |
| 2152A6   | Blue        | .83 (21.1) | 8.04      |

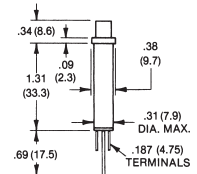

#### GLO-DOT MINIATURE NEON PILOT LIGHTS—SERIES 2150QA AND 2152QA WITH .187" TERMINALS 120 VAC

| Cat. No. | Lens Colour | Net Price |
|----------|-------------|-----------|
| 2150QA1  | Red         | \$5.42    |
| 2150QA3  | Amber       | 5.42      |
| 2150QA4  | White       | 5.42      |
| 2152QA5  | Green       | 8.42      |

Mounting Hole— $\frac{5}{16}$ " Diameter. Supplied with Push-On Speednut.

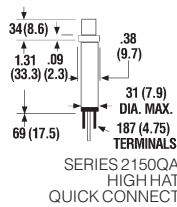

SERIES 2150QA  
HIGH HAT  
QUICK CONNECT

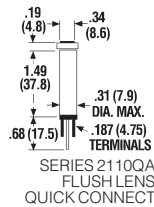

SERIES 2110QA  
FLUSH LENS  
QUICK CONNECT

## GLO-DOT MINIATURE NEON PILOT LIGHTS SERIES 2150, 2110

These miniature neon pilot lights are engineered for long service reliability. Rugged, unaffected by the shock and vibration. Two lens shapes, flush and high-hat which are available in five colours: red, amber, white, clear and green. Mounting hole is .31" minimum diameter. **Average Operating Life:** 25,000 hours. UL recognized and CSA approved. Supplied with push-on speed nut (SN1287). Units supplied with 4.4"-4.8" wire terminals, stripped 1/2" or .187"-.020" tinned brass terminals.

| Cat. No. | Lens Colour | VAC     | Net Price |
|----------|-------------|---------|-----------|
| 2151A1   | Red         | 208-250 | \$5.02    |
| 2151A2   | Clear       | 208-250 | 5.02      |
| 2151A3   | Amber       | 208-250 | 5.02      |
| 2151A4   | White       | 208-250 | 5.02      |
| 2153A5*  | Green       | 208-250 | 8.04      |
| 2153A6†  | Blue        | 208-250 | 8.04      |
| 2111A1   | Red         | 208-250 | 4.71      |
| 2111A2   | Clear       | 208-250 | 4.71      |
| 2111A3   | Amber       | 208-250 | 4.71      |
| 2111A4   | White       | 208-250 | 4.71      |
| 2113A5*  | Green       | 208-250 | 7.08      |
| 2113A6†  | Blue        | 208-250 | 7.08      |
| 2151QA1  | Red         | 208-250 | 5.42      |
| 2151QA3  | Amber       | 208-250 | 5.42      |
| 2151QA4  | White       | 208-250 | 5.42      |
| 2153QA5* | Green       | 208-250 | 8.42      |
| 2111QA1  | Red         | 208-250 | 5.08      |
| 2111QA2  | Clear       | 208-250 | 5.08      |
| 2111QA3  | Amber       | 208-250 | 5.08      |
| 2111QA4  | White       | 208-250 | 5.08      |
| 2113QA5* | Green       | 208-250 | 7.51      |

\*Incorporates G2B lamp and resistor.

†Incorporates T2B lamp and resistor.

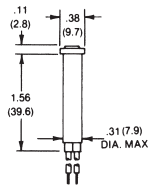
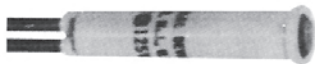

## GLO-DOT MINIATURE NEON PILOT LIGHTS WITH WIRE LEADS SERIES 2120A 120 VAC

| Cat. No. | Lens Colour | Net Price |
|----------|-------------|-----------|
| 2120A1   | Red         | \$4.71    |
| 2120A3   | Amber       | 4.71      |
| 2120A4   | White       | 4.71      |

Mounting Hole—5/16" Diameter. Supplied with Push-On Speednut.

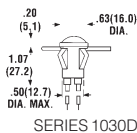

SERIES 1030D

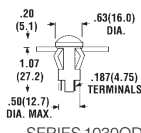

SERIES 1030QD

## SERIES 1000 NEON LAMPS

### PILOT LAMPS WITH LOW-PROFILE LENSES

| Cat. No.  | Lens Colour | VAC     | Net Price |
|-----------|-------------|---------|-----------|
| 1030D1†   | Red         | 105-125 | \$4.74    |
| 1030D3†   | Amber       | 105-125 | 5.11      |
| 1030D4†   | White       | 105-125 | 4.74      |
| 1032D5†*  | Green       | 105-125 | 7.11      |
| 1030QD1‡  | Red         | 105-125 | 5.11      |
| 1030QD3‡  | Amber       | 105-125 | 5.11      |
| 1030QD4‡  | White       | 105-125 | 5.11      |
| 1032QD5‡* | Green       | 105-125 | 7.54      |

†With wire leads 4.4/4.8" long, striped .43/.57".

‡With .187"-.020" tinned brass terminals.

\*Incorporates G2B lamp and resistor.

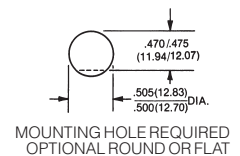
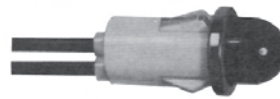

MOUNTING HOLE REQUIRED  
OPTIONAL ROUND OR FLAT

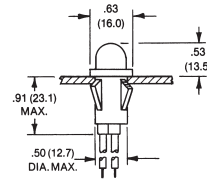

SERIES 1090A

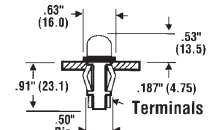

SERIES 1090QA

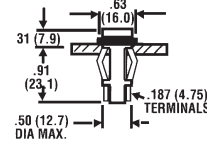

SERIES 1090QC

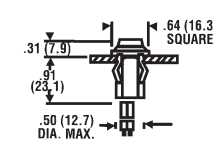

SERIES 1090N

## OMNI-GLOW INCANDESCENT PILOT LIGHTS—SERIES 1090A

| Cat. No.       | Lens Colour | Net Price |
|----------------|-------------|-----------|
| <b>6 VOLT</b>  |             |           |
| 1090A1-6V      | Red         | \$6.08    |
| 1090A3-6V      | Amber       | 6.08      |
| 1090A4-6V      | White       | 6.43      |
| 1090A5-6V      | Green       | 6.43      |
| 1090A6-6V      | Blue        | 6.08      |
| <b>12 VOLT</b> |             |           |
| 1090A1-12V     | Red         | 6.43      |
| 1090A3-12V     | Amber       | 6.43      |
| 1090A4-12V     | White       | 6.43      |
| 1090A5-12V     | Green       | 6.43      |
| 1090A6-12V     | Blue        | 6.43      |
| 1090QA1-12V    | Red         | 6.86      |
| 1090QA3-12V    | Amber       | 6.86      |
| 1090QA4-12V    | White       | 6.86      |
| 1090QA5-12V    | Green       | 6.86      |
| 1090QA6-12V    | Blue        | 6.86      |
| 1090N1-12V     | Red         | 6.86      |
| 1090N3-12V     | Amber       | 6.86      |
| 1090N4-12V     | White       | 6.86      |
| 1090N5-12V     | Green       | 6.86      |
| 1090QC1-12V    | Red         | 6.86      |
| 1090QC3-12V    | Amber       | 6.86      |
| 1090QC4-12V    | White       | 6.86      |
| 1090QC5-12V    | Green       | 6.86      |
| <b>28 VOLT</b> |             |           |
| 1090A1-28V     | Red         | 6.43      |
| 1090A3-28V     | Amber       | 6.43      |
| 1090A4-28V     | White       | 6.43      |
| 1090A5-28V     | Green       | 6.43      |
| 1090A6-28V     | Blue        | 6.43      |
| 1090QA1-28V    | Red         | 6.86      |
| 1090QA3-28V    | Amber       | 6.86      |
| 1090QA4-28V    | White       | 6.86      |
| 1090QA5-28V    | Green       | 6.86      |
| 1090QA6-28V    | Blue        | 6.86      |
| 1090N1-28V     | Red         | 6.86      |
| 1090N3-28V     | Amber       | 6.86      |
| 1090N4-28V     | White       | 6.86      |
| 1090N5-28V     | Green       | 6.86      |
| 1090QC1-28V    | Red         | 6.86      |
| 1090QC3-28V    | Amber       | 6.86      |
| 1090QC4-28V    | White       | 6.86      |
| 1090QC5-28V    | Green       | 6.86      |
| 1090QC6-28V    | Blue        | 15.21     |

Mounting Hole—1/2" Diameter.

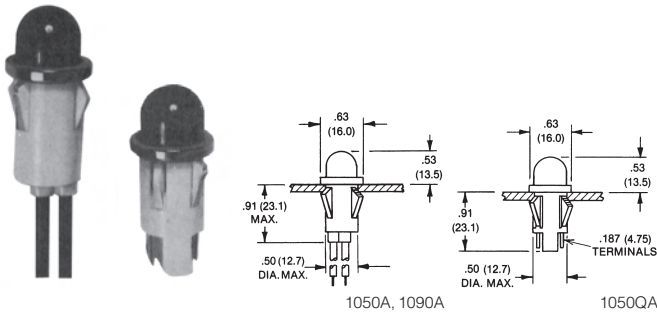

### OMNI-GLOW NEON PILOT LIGHTS—SERIES 1050A AND 1050QA

| Cat. No. | Lens Colour | Net Price |
|----------|-------------|-----------|
|----------|-------------|-----------|

#### WIRE LEADS

##### 120 VAC

| Cat. No. | Lens Colour | Net Price |
|----------|-------------|-----------|
| 1050A1   | Red         | \$4.74    |
| 1050A2   | Clear       | 4.74      |
| 1050A3   | Amber       | 4.74      |
| 1050A4   | White       | 4.74      |
| 1052A5   | Green       | 7.11      |
| 1052A6   | Blue        | 7.11      |

##### 250 VAC

| Cat. No. | Lens Colour | Net Price |
|----------|-------------|-----------|
| 1051A1   | Red         | 2.60      |
| 1051A2   | Clear       | 2.60      |
| 1051A3   | Amber       | 2.60      |
| 1051A4   | White       | 2.60      |
| 1053A5   | Green       | 3.87      |
| 1053A6   | Blue        | 3.87      |

#### WITH .187" TERMINALS

##### 120 VAC

| Cat. No. | Lens Colour | Net Price |
|----------|-------------|-----------|
| 1050QA1  | Red         | 5.11      |
| 1050QA2  | Clear       | 5.11      |
| 1050QA3  | Amber       | 5.11      |
| 1050QA4  | White       | 5.11      |
| 1052QA5  | Green       | 7.54      |
| 1052QA6  | Blue        | 7.54      |

##### 250 VAC

| Cat. No. | Lens Colour | Net Price |
|----------|-------------|-----------|
| 1051QA1  | Red         | 2.81      |
| 1051QA3  | Amber       | 2.81      |
| 1051QA4  | White       | 2.81      |
| 1053QA5  | Green       | 4.13      |

Mounting Hole— $\frac{1}{2}$ " Diameter.

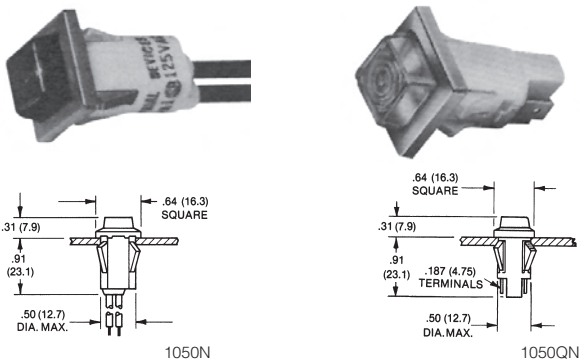

### OMNI-GLOW INCANDESCENT PILOT LIGHTS—SERIES 1090N

| Cat. No. | Lens Colour | Net Price |
|----------|-------------|-----------|
|----------|-------------|-----------|

#### WITH WIRE LEADS

##### 12 VOLT

| Cat. No.   | Lens Colour | Net Price |
|------------|-------------|-----------|
| 1090N1-12V | Red         | \$6.86    |
| 1090N3-12V | Amber       | 6.86      |
| 1090N4-12V | White       | 6.86      |
| 1090N5-12V | Green       | 6.86      |

##### 28 VOLT

| Cat. No.   | Lens Colour | Net Price |
|------------|-------------|-----------|
| 1090N1-28V | Red         | 6.86      |
| 1090N3-28V | Amber       | 6.86      |
| 1090N4-28V | White       | 6.86      |
| 1090N5-28V | Green       | 6.86      |

Mounting Hole— $\frac{1}{2}$ " Diameter.

### OMNI-GLOW NEON PILOT LIGHTS—SERIES 1050N AND 1050QN

| Cat. No. | Lens Colour | Net Price |
|----------|-------------|-----------|
|----------|-------------|-----------|

#### WITH WIRE LEADS 120 VAC

| Cat. No. | Lens Colour | Net Price |
|----------|-------------|-----------|
| 1050N1   | Red         | \$5.11    |
| 1050N2   | Clear       | 5.11      |
| 1050N3   | Amber       | 5.11      |
| 1050N4   | White       | 5.11      |
| 1052N5   | Green       | 7.54      |

#### WITH .187" TERMINALS 120 VAC

| Cat. No. | Lens Colour | Net Price |
|----------|-------------|-----------|
| 1050QN1  | Red         | 5.55      |
| 1050QN3  | Amber       | 5.55      |
| 1050QN4  | White       | 5.55      |
| 1052QN5  | Green       | 8.01      |

Mounting Hole— $\frac{1}{2}$ " Diameter.

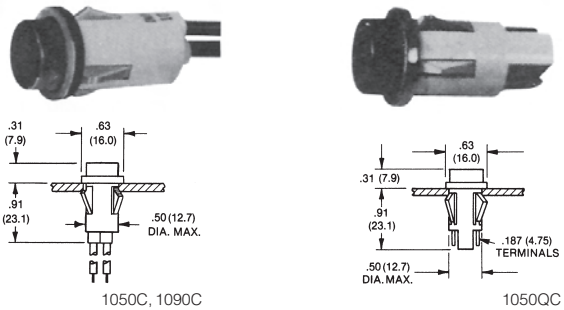

### OMNI-GLOW INCANDESCENT PILOT LIGHTS—SERIES 1090C

| Cat. No. | Lens Colour | Net Price |
|----------|-------------|-----------|
|----------|-------------|-----------|

#### WITH WIRE LEADS

##### 12 VOLT

| Cat. No.   | Lens Colour | Net Price |
|------------|-------------|-----------|
| 1090C1-12V | Red         | \$4.34    |
| 1090C3-12V | Amber       | 4.34      |
| 1090C4-12V | White       | 4.34      |
| 1090C5-12V | Green       | 4.34      |

##### 28 VOLT

| Cat. No.   | Lens Colour | Net Price |
|------------|-------------|-----------|
| 1090C1-28V | Red         | 4.34      |
| 1090C3-28V | Amber       | 4.34      |
| 1090C4-28V | White       | 4.34      |
| 1090C5-28V | Green       | 4.34      |

Mounting Hole— $\frac{1}{2}$ " Diameter.

### OMNI-GLOW NEON PILOT LIGHTS—SERIES 1050C AND 1051QC

| Cat. No. | Lens Colour | Net Price |
|----------|-------------|-----------|
|----------|-------------|-----------|

#### WIRE LEADS

##### 120 VAC

| Cat. No. | Lens Colour | Net Price |
|----------|-------------|-----------|
| 1050C1   | Red         | \$4.74    |
| 1050C2   | Clear       | 4.74      |
| 1050C3   | Amber       | 4.74      |
| 1050C4   | White       | 4.74      |
| 1052C5   | Green       | 7.11      |

##### 250 VAC

| Cat. No. | Lens Colour | Net Price |
|----------|-------------|-----------|
| 1051C1   | Red         | 4.74      |
| 1051C2   | Clear       | 4.74      |
| 1051C3   | Amber       | 4.74      |
| 1051C4   | White       | 4.74      |
| 1053C5   | Green       | 7.11      |

#### WITH .187" TERMINALS

##### 120 VAC

| Cat. No. | Lens Colour | Net Price |
|----------|-------------|-----------|
| 1050QC1  | Red         | 5.11      |
| 1050QC2  | Clear       | 5.11      |
| 1050QC3  | Amber       | 5.11      |
| 1050QC4  | White       | 5.11      |
| 1052QC5  | Green       | 7.54      |

##### 250 VAC

| Cat. No. | Lens Colour | Net Price |
|----------|-------------|-----------|
| 1051QC1  | Red         | 5.11      |
| 1051QC3  | Amber       | 5.11      |
| 1051QC4  | White       | 5.11      |
| 1053QC5  | Green       | 7.54      |

Mounting Hole— $\frac{1}{2}$ " Diameter.



Continued on next page....

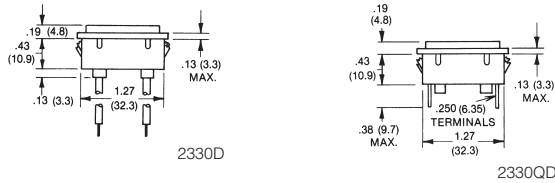

### LINE-O-LITE NEON PILOT LIGHTS—SERIES 2330D AND 2330QD

| Cat. No.                            | Lens Colour | Net Price |
|-------------------------------------|-------------|-----------|
| <b>WITH WIRE LEADS 120 VAC</b>      |             |           |
| 2330D1                              | Red         | \$5.64    |
| 2330D3                              | Amber       | 5.64      |
| 2330D4                              | White       | 5.64      |
| 2332D5                              | Green       | 7.86      |
| <b>WITH .250" TERMINALS 120 VAC</b> |             |           |
| 2330QD1                             | Red         | 5.70      |
| 2330QD3                             | Amber       | 5.70      |
| 2330QD4                             | White       | 5.70      |
| 2332QD5                             | Green       | 8.07      |

### LINE-O-LITE INCANDESCENT LIGHTS—SERIES 2390QD

| Cat. No.                        | Lens Colour | Net Price |
|---------------------------------|-------------|-----------|
| <b>WITH .250" TERMINALS 28V</b> |             |           |
| 2390QD1-28V                     | Red         | \$7.12    |
| 2390QD3-28V                     | Amber       | 7.12      |
| 2390QD4-28V                     | White       | 7.12      |
| 2390QD5-28V                     | Green       | 7.12      |

Will snap fit into .032/.100" (.81/2.54 mm) thick panel; use speednut SN1963 for other panel thicknesses. Speednut not supplied. Mounting Hole—.395/.400" (10.03/10.16 mm) x 1.276/1.281" (32.41/32.54 mm).

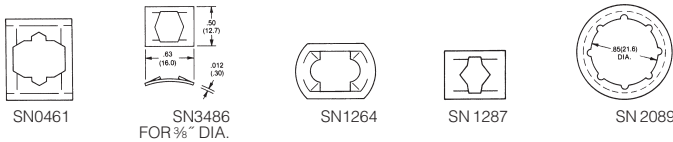

| Cat. No. | Lamp Model Series                              | Net Price |
|----------|--|-----------|
| SN0461   | 1050, 1051, 1090, 3000                         | \$1.19    |
| SN1287   | 2110, 2112, 2150, 2152, 2191, 2194, 2195, 2990 | .19       |
| SN2089   | 2620   | .31       |
| SN3486   | 3/8" Dia.                                      | .25       |

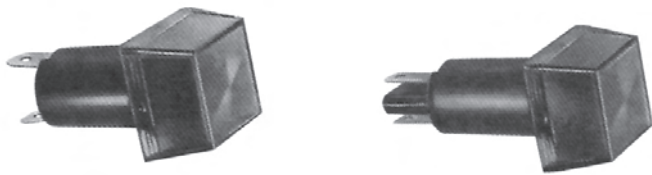

ROUND LENS

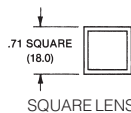

SQUARE LENS

### SOLID STATE GLO-DOT 2191L AND 2191U SERIES PILOT LIGHT LENSES FOR 3040-3062 SERIES

MINI-SLIDE individual pilot light lenses are available in 2 shapes; round and square. Lenses are molded polycarbonate and either round or square lens will fit both 3040 and 3062 sockets. Each lens is available in 7 bright colours (see table). Round and square lenses may be supplied hot-stamped with legends as desired. All lenses are keyed to socket for correct orientation.

### MINI-SLIDE PILOT LIGHT LENSES 3040 AND 3062 SERIES

| Lens Colour | Round-Lens Part No. | Square-Lens Part No. |
|-------------|---------------------|----------------------|
| Red         | 3111                | 3121                 |
| Clear       | 3112                | 3122                 |
| Amber       | 3113                | 3123                 |
| White       | 3114                |                      |
| Green       | 3115                | 3125                 |
| Blue        | 3116                | 3126                 |
| Yellow      | 3117                | 3127                 |

| Cat. No.       | Net Price |
|----------------|-----------|
| 3111 thru 3127 | \$1.25    |

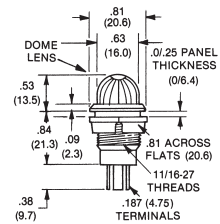
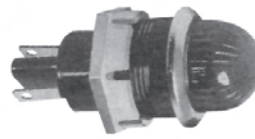

### PILOT LIGHT ASSEMBLIES—SERIES 2800

Series 2800 pilot light assemblies are bright, highly visible, beautiful pilot lights styled with either solid black or stainless steel bezels. The units feature round, light diffusing screw-in lenses. They come in a variety of colours and utilize "PSB" Telephone Slide Base lamps in a full range of voltages from 6 to 120 volts. The lenses are molded polycarbonate, and the screw-in design permits easy relamping from the front panel. CSA approved for 120 volt service. Leads can be attached by soldering or with quick-connect receptacles for .205 x .020 tab. Mounts to panel by means of nylon torque-limiting nut. Assemblies mount in an 1/16" diameter hole.

### SERIES 2800 SOCKET ASSEMBLIES

| Cat. No. | Description                         | Net Price |
|----------|-------------------------------------|-----------|
| 2802     | All Plastic Black Bezel             | \$4.43    |
| 2803     | Mirror-Finish Stainless Steel Bezel | 4.99      |

### SERIES 2800 LENSES

| Cat. No.         | Lens Colour |       |       |       |       |      | Net Price |
|------------------|-------------|-------|-------|-------|-------|------|-----------|
|                  | Red         | Clear | Amber | White | Green | Blue |           |
| <b>DOME LENS</b> |             |       |       |       |       |      |           |
| 2811             | 2812        | 2813  | 2814  | 2815  | 2816  | 2817 | \$1.00    |
| <b>FLAT LENS</b> |             |       |       |       |       |      |           |
| 2851             | 2852        | 2853  | 2854  | 2855  | 2856  | 2857 | 1.00      |

### MODEL 3062 SERIES SOCKETS

For use with "PSB" Telephone Slide Base Lamps.

MINI-SLIDE Model 3062 assemblies accept "PSB" Telephone Slide Base lamps. Socket molded of black polyester is CSA approved for 120 volt service and takes both round and square lenses. Lenses snap on or off for easy front panel relamping. Mount in either 1/2" round or standard "D" holes and are held in place with push-in speed nuts. Speed nut SN0461 supplied with each socket.

### I.D.I. MODEL 3062 SERIES SOCKETS

| Cat. No. | Terminal Size | Dim. "A" | Dim. "B" | Net Price |
|----------|---------------|----------|----------|-----------|
| 3062     | .205 x .020   | 3/8"     | 5/16"    | \$2.56    |

MINI-SLIDE 3040 and 3062 sockets mount in either 1/2" round or standard "D" holes and are held in place with push-on Speed Nuts. Speednut #461 supplied.

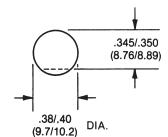
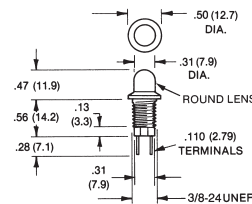

MOUNTING HOLE REQUIRED OPTIONAL ROUND OR FLAT

| Cat. No. | Description | Net Price |
|----------|-------------|-----------|
|----------|-------------|-----------|

### SERIES 4600 SOCKET ASSEMBLIES

|      |  |        |
|------|--|--------|
| 4611 | Threaded socket with zinc finished hex nut and internal tooth lock washer. | \$3.06 |
|------|--|--------|

### SERIES 4600 LENS

|      |                   |      |
|------|-------------------|------|
| 4621 | Red Round Lens    | 1.34 |
| 4623 | Amber Round Lens  | 1.34 |
| 4625 | Green Round Lens  | 1.34 |
| 4626 | Blue Round Lens   | 1.34 |
| 4627 | Yellow Round Lens | 1.34 |