

DS1086LPMB1 Peripheral Module

General Description

The DS1086LPMB1 peripheral module provides the necessary hardware to interface the DS1086L 3.3V spread-spectrum EconOscillator™ to any system that utilizes Pmod™-compatible expansion ports configurable for I²C communication. The DS1086L is a programmable clock generator that produces a spread-spectrum (dithered) square-wave output of frequencies from 130kHz to 66.6MHz. The selectable dithered output reduces radiated-emission peaks by dithering the frequency 0.5%, 1%, 2%, 4%, or 8% below the programmed frequency. The DS1086L has a power-down mode and an output-enable control for power-sensitive applications.

Refer to the DS1086L IC data sheet for detailed information regarding operation of the IC.

Features

- ◆ User-Programmable 130kHz to 66.6MHz Square Wave
- ◆ No External Timing Components Required
- ◆ 6-Pin Pmod-Compatible Connector (I²C)
- ◆ Example Software Written in C for Portability
- ◆ Secondary Header Allows Daisy-Chaining of Additional Modules on the I²C Bus
- ◆ Output Header Provides Access to Control Signals for External Circuitry
- ◆ RoHS Compliant
- ◆ Proven PCB Layout
- ◆ Fully Assembled and Tested

[Ordering Information](#) appears at end of data sheet.

DS1086LPMB1 Peripheral Module

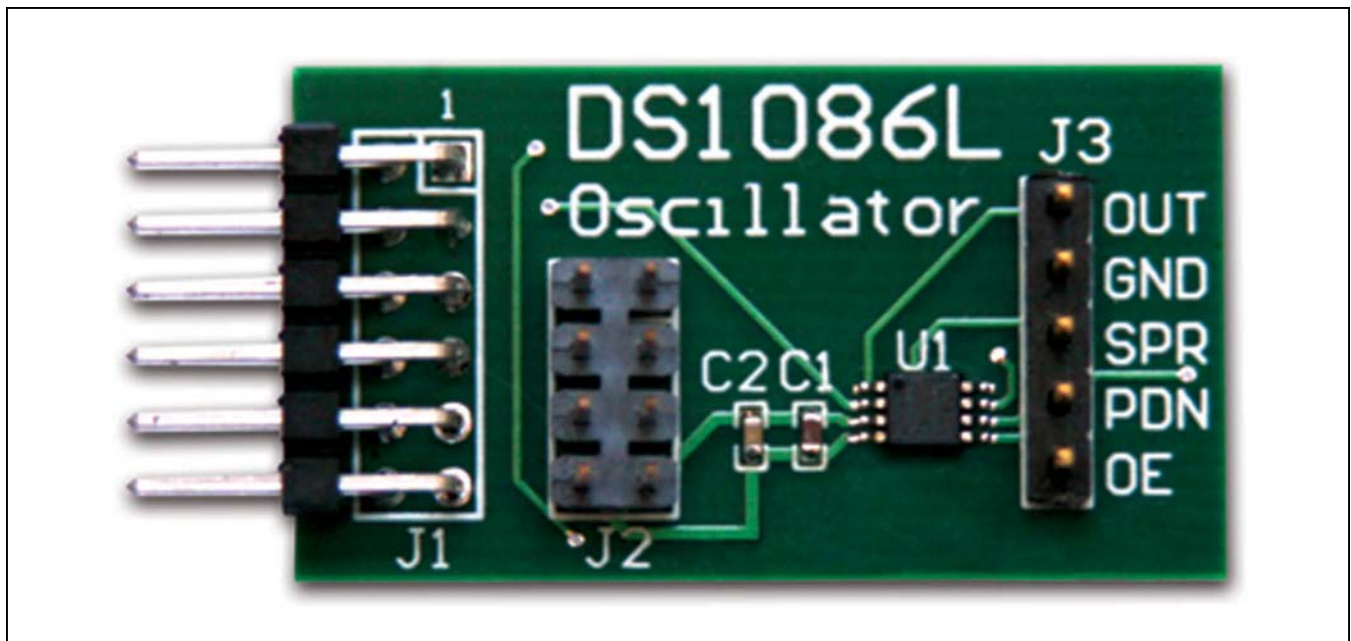

EconOscillator is a trademark of Maxim Integrated Products, Inc.

Pmod is a trademark of Digilent Inc.

For pricing, delivery, and ordering information, please contact Maxim Direct at 1-888-629-4642, or visit Maxim Integrated's website at www.maximintegrated.com.

DS1086LPMB1 Peripheral Module

Component List

DESIGNATION	QTY	DESCRIPTION
C1	1	0.01 μ F \pm 10%, 16V X7R ceramic capacitor (0603) Murata GRM188R71C103KA01D
C2	1	0.1 μ F \pm 10%, 16V X7R ceramic capacitor (0603) Murata GRM188R71C104KA01D
J1	1	12-pin (2 x 6) right-angle male header
J2	1	8-pin (2 x 4) straight male header

DESIGNATION	QTY	DESCRIPTION
J3	1	5-pin straight male header
R1, R2, R8, R9, R10	5	4.7k Ω \pm 5% resistors (0603)
R3, R4, R5	3	1k Ω \pm 5% resistors (0603)
R6, R7	2	150k Ω \pm 5% resistors (0603)
U1	1	3.3V spread-spectrum EconOscillator (8 μ SOP) Maxim DS1086LU+
—	1	PCB: EPCB1086L

Component Supplier

SUPPLIER	PHONE	WEBSITE
Murata Electronics North America, Inc.	770-436-1300	www.murata-northamerica.com

Note: Indicate that you are using the DS1086LPMB1 when contacting this component supplier.

Detailed Description

I²C Interface

The DS1086LPMB1 peripheral module can interface to the host in one of two ways. It can plug directly into a Pmod-compatible port (configured for I²C) through connector J1, or in this case, other I²C boards can attach to the same I²C bus through connector J2.

I²C Interface (Daisy-Chaining Modules)

Alternatively, the peripheral module can connect to other I²C-based Pmod modules using a 4-conductor ribbon cable connecting to the J2 connector. In this situation, pins 1-4 and 5-8 of J2 provide two connections to the I²C bus, allowing the module to be inserted into an I²C bus daisy-chain.

Connector J1 provides connection of the module to the Pmod host. The pin assignments and functions adhere to the Pmod standard recommended by Digilent. See Table 1.

The J2 connector allows the module to be connected through a daisy-chain from another I²C module and/or provide I²C and power connections to other I²C modules on the same bus. See Table 2.

Table 1. Connector J1 (I²C Communication)

PIN	SIGNAL	DESCRIPTION
1	$\overline{\text{PDN}}$	Power-down. When the pin is high, the output buffer is enabled. When the pin is low, the master oscillator is disabled (power-down mode).
2	SPRD	Dither enable. When the pin is high, the dither is enabled. When the pin is low, the dither is disabled.
3	SCL	I ² C serial clock
4	SDA	I ² C serial data
5	GND	Ground
6	VCC	Power supply
7	OE	Output enable. When the pin is high, the output buffer is enabled. When the pin is low, the output is disabled but the master oscillator is still on.
8	N.C.	Not connected
9	SCL	I ² C serial clock
10	SDA	I ² C serial data
11	GND	Ground
12	VCC	Power supply

DS1086LPMB1 Peripheral Module

External Control Signals

The IC implements pins to control output enable (OE), power-down (PDN), and dither enable (SPRD). These pins can be controlled either by the host (through the Pmod connector) or by external circuitry through the 5-pin output connector. In cases where one or more of these signals is driven from an external source, 1k Ω resistors R3, R4, and R5 limit the current to/from the host. However, this also increases the apparent load to the external driving source. If the external source is incapable of driving this load (1k Ω ||4.7k Ω), the signal(s) from the host should either be put into three-state (open) or resistors R3, R4, and/or R5 should be removed.

The J3 connector provides the output signal as well as external inputs to the control signals. Note that the control lines from the host (SPRD, $\overline{\text{PDN}}$, OE) must either be three-stated or the external control signals must be able to drive the additional load. See Table 3.

Software and FPGA Code

Example software and drivers are available that execute directly without modification on several FPGA development boards that support an integrated or synthesized microprocessor. These boards include the Digilent Nexys 3, Avnet LX9, and Avnet ZEDBoard, although other platforms can be added over time. Maxim provides complete Xilinx ISE projects containing HDL, Platform

Studio, and SDK projects. In addition, a synthesized bit stream, ready for FPGA download, is provided for the demonstration application.

The software project (for the SDK) contains several source files intended to accelerate customer evaluation and design. These include a base application (maximModules.c) that demonstrates module functionality and uses an API interface (maximDeviceSpecificUtilities.c) to set and access Maxim device functions within a specific module.

The source code is written in standard ANSI C format, and all API documentation including theory/operation, register description, and function prototypes are documented in the API interface file (maximDeviceSpecificUtilities.h & .c).

The complete software kit is available for download www.maximintegrated.com. Quick start instructions are also available as a separate document.

Table 2. Connector J2 (I²C Expansion)

PIN	SIGNAL	DESCRIPTION
1	SCL	I ² C serial clock
2	SDA	I ² C serial data
3	GND	Ground
4	VCC	Power supply
5	SCL	I ² C serial clock
6	SDA	I ² C serial data
7	GND	Ground
8	VCC	Power supply

Table 3. Connector J3 (External Interface)

PIN	SIGNAL	DESCRIPTION
1	OUT	Oscillator output. The output frequency is set by the OFFSET, DAC, and prescaler registers.
2	GND	Ground
3	SPRD	Dither enable. When the pin is high, the dither is enabled. When the pin is low, the dither is disabled.
4	$\overline{\text{PDN}}$	Power-down. When the pin is high, the output buffer is enabled. When the pin is low, the master oscillator is disabled (power-down mode).
5	OE	Output enable. When the pin is high, the output buffer is enabled. When the pin is low, the output is disabled but the master oscillator is still on.

DS1086LPMB1 Peripheral Module

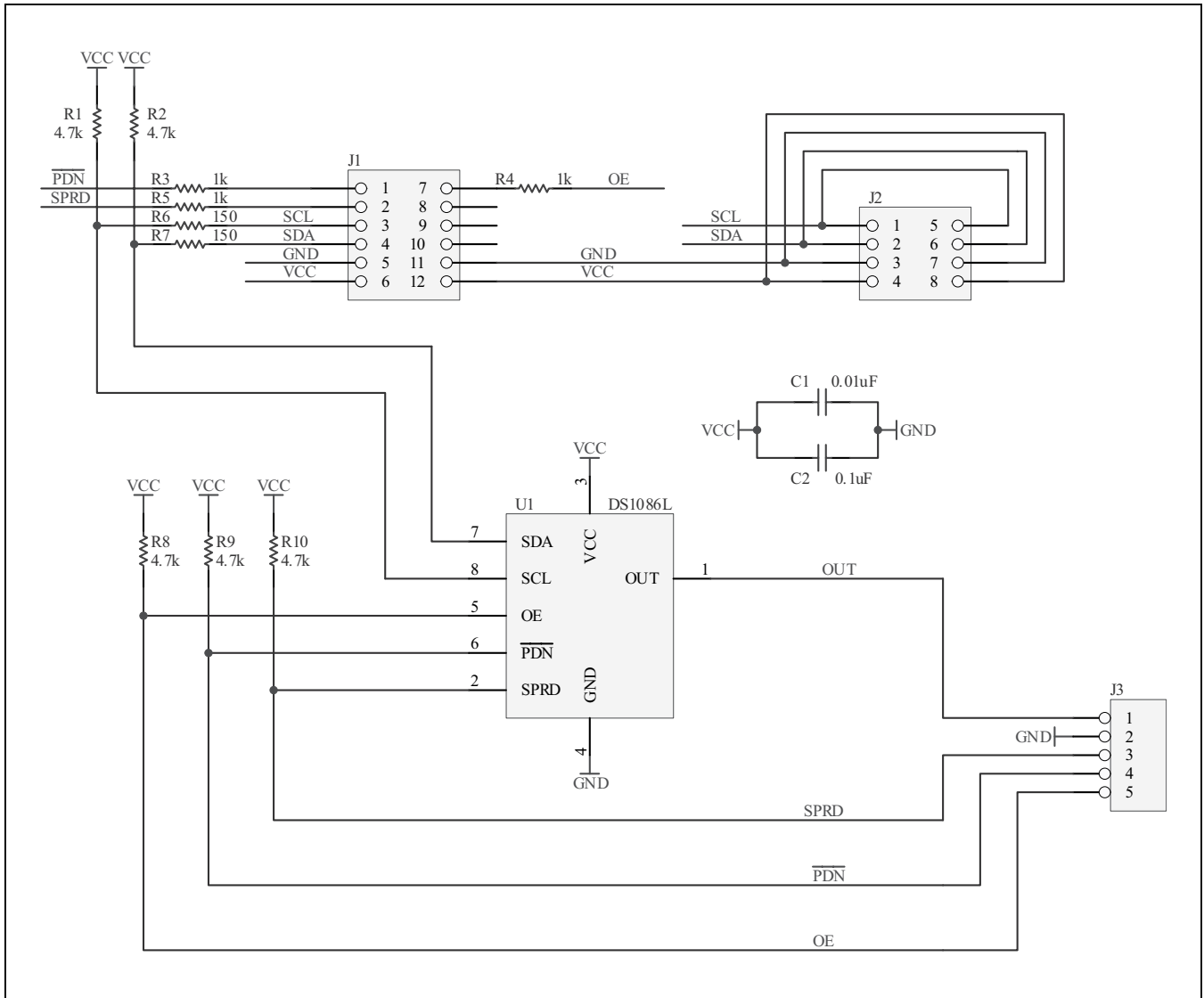

Figure 1. DS1086LPMB11 Peripheral Module Schematic

DS1086LPMB1 Peripheral Module

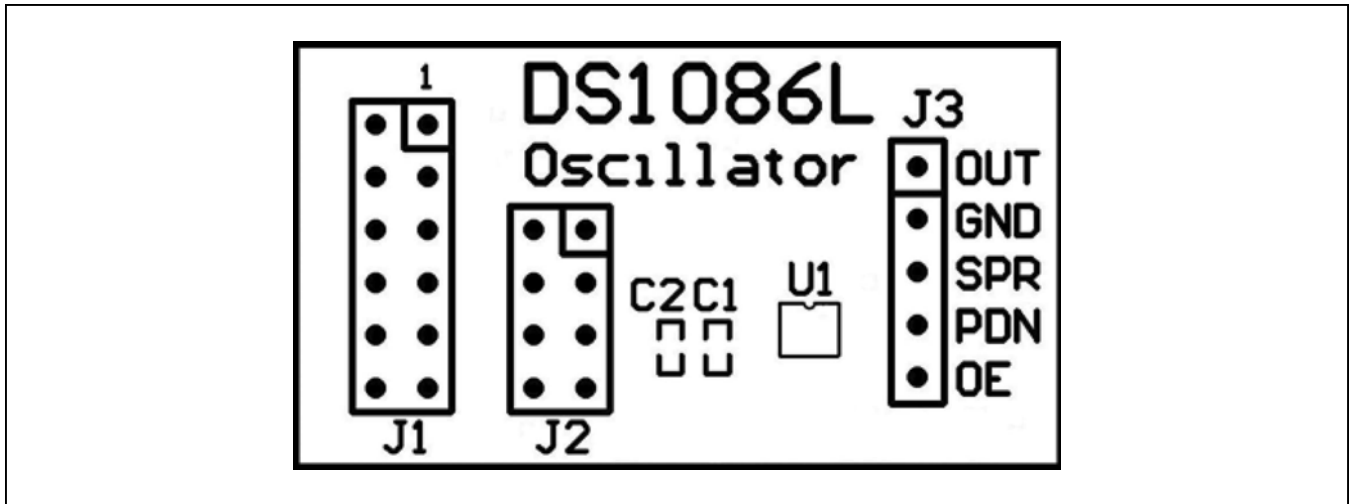

Figure 2. DS1086LPMB11 Peripheral Module Component Placement Guide—Component Side

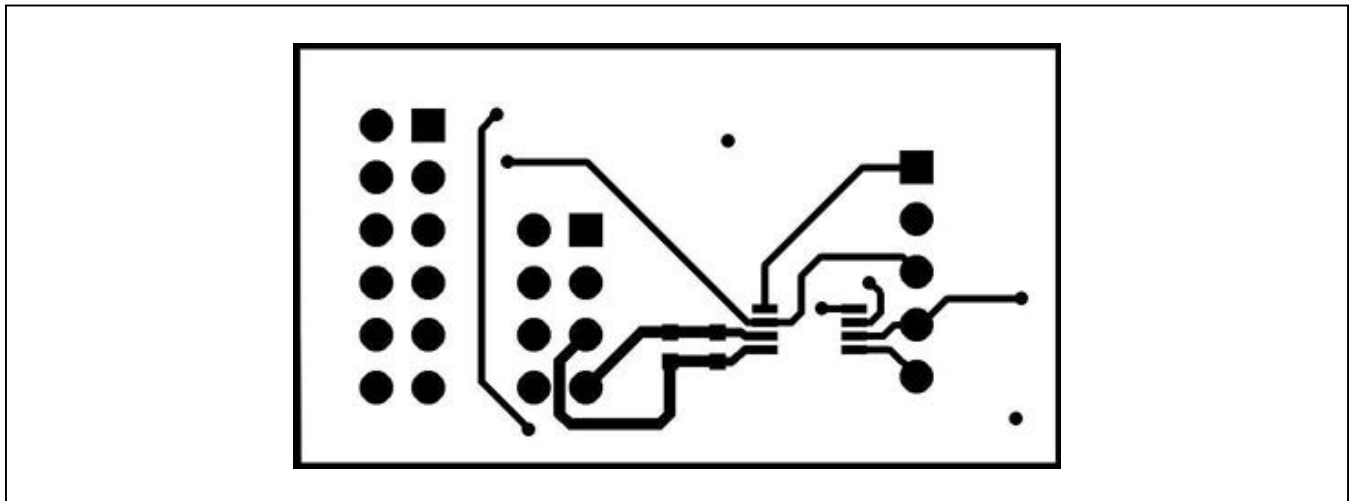

Figure 3. DS1086LPMB11 Peripheral Module PCB Layout—Component Side

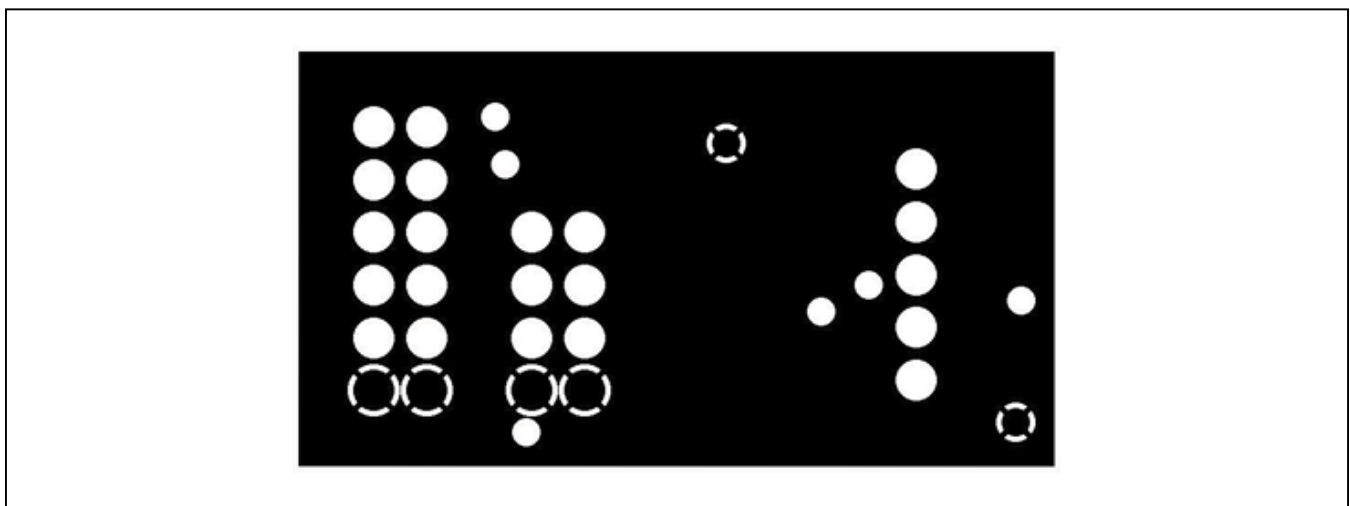

Figure 4. DS1086LPMB11 Peripheral Module PCB Layout—Inner Layer 1 (Ground)

DS1086LPMB1 Peripheral Module

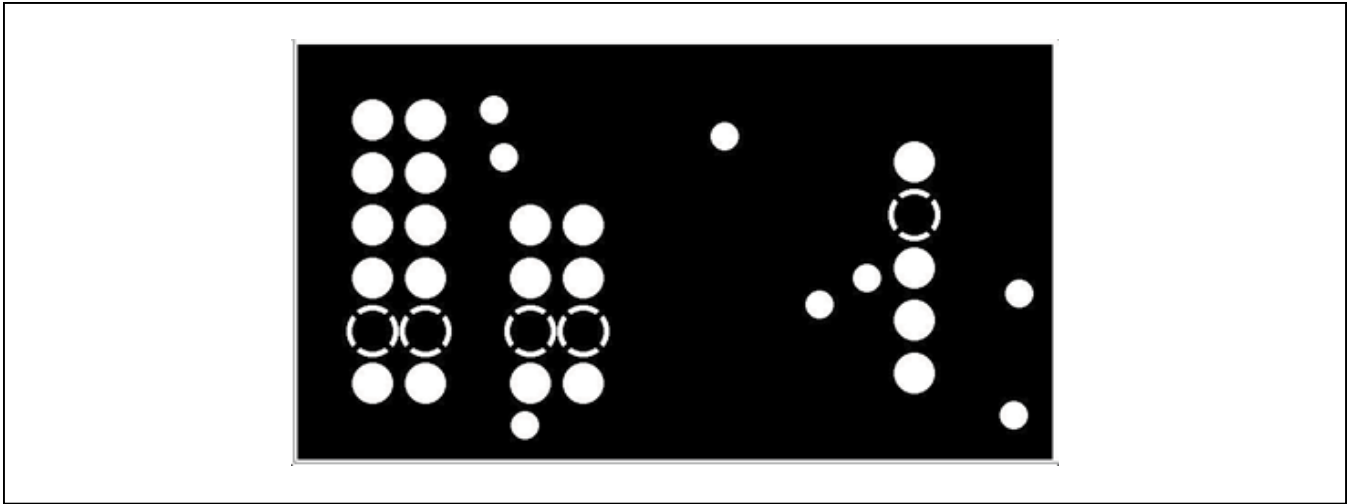

Figure 5. DS1086LPMB1 Peripheral Module PCB Layout—Inner Layer 2 (Power)

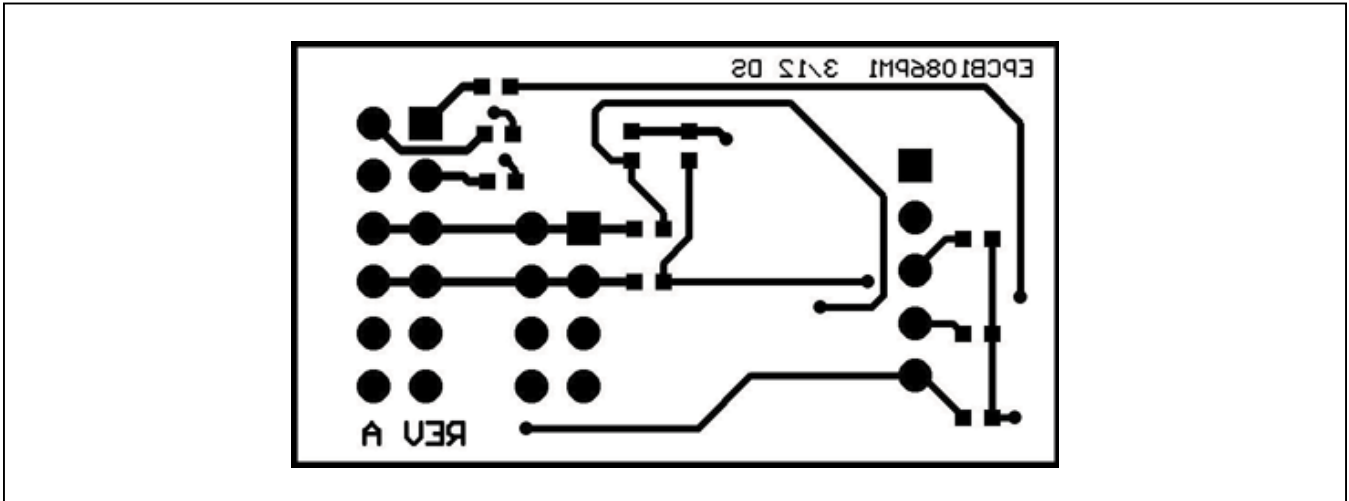

Figure 6. DS1086LPMB1 Peripheral Module PCB Layout—Solder Side

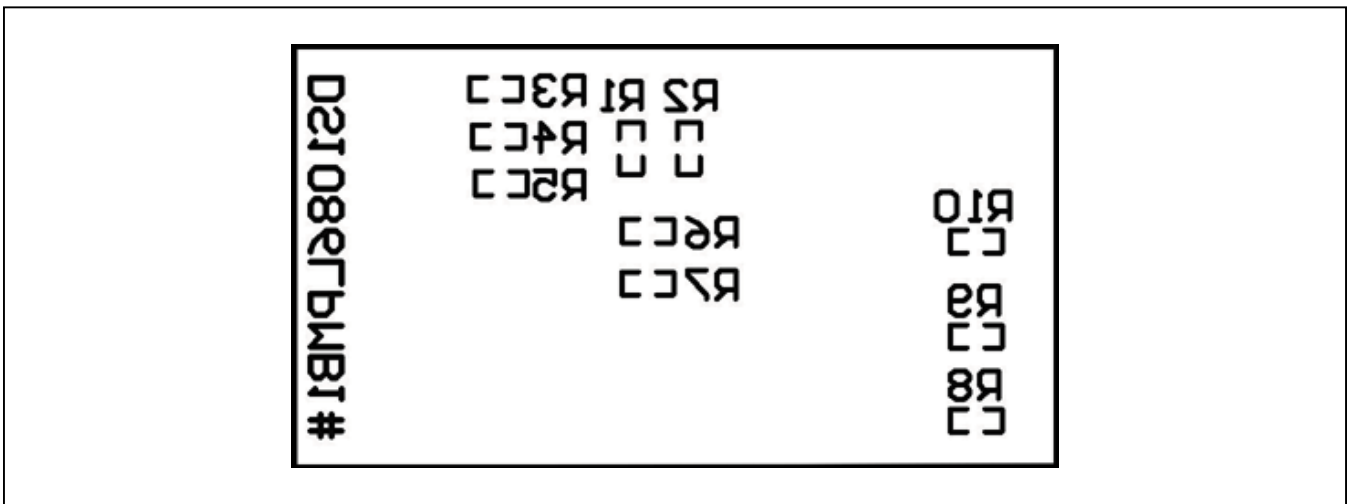

Figure 7. DS1086LPMB1 Peripheral Module Component Placement Guide—Solder Side

DS1086LPMB1 Peripheral Module

Ordering Information

PART	TYPE
DS1086LPMB1#	Module

#Denotes RoHS compliant.

DS1086LPMB1 Peripheral Module

Revision History

REVISION NUMBER	REVISION DATE	DESCRIPTION	PAGES CHANGED
0	5/12	Initial release	—



Maxim Integrated cannot assume responsibility for use of any circuitry other than circuitry entirely embodied in a Maxim Integrated product. No circuit patent licenses are implied. Maxim Integrated reserves the right to change the circuitry and specifications without notice at any time. The parametric values (min and max limits) shown in the Electrical Characteristics table are guaranteed. Other parametric values quoted in this data sheet are provided for guidance.

Maxim Integrated 160 Rio Robles, San Jose, CA 95134 USA 1-408-601-1000

8