

Mitutoyo

Mitutoyo Quality

PH-3515F PROFILE PROJECTOR

Heavy-Duty, Bench-Top Model with Horizontal Optical System

OPTICAL MEASURING



Bulletin No. 2210

Mitutoyo introduces the PH-3515F Profile Projectors that will meet any optical measuring or inspection challenge your shop can offer!

FEATURES

- Erect image on high brightness screen.
- 14" (353mm) dia. protractor screen with crosshairs and staggered lines for easy alignment.
- Digital angle measurement of 1' or 0.01° with built in angle counter.
- Floating-type workstage incorporates linear scales for fast, accurate measurement.
- Halogen contour illumination.
- Fiber-optic illumination cables and halogen included.
- Suitable for thread pitch measurements — free from blurred or distorted images when the workpiece is angled.
- Wide range of accessories for varied applications.



Also available:
Optional side mount surface illumination unit (172-423)

DIMENSIONS

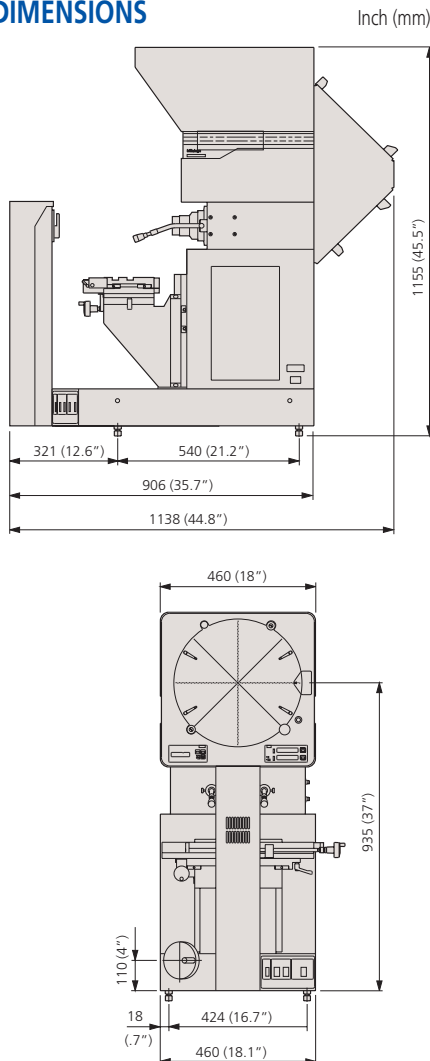

SPECIFICATIONS

Model No.	PH-3515F	
Order No.	172-868A	
Projected Image	Erect image	
Protractor screen	Effective diameter	14" / 353mm
	Screen material	Fine ground glass
	Reference line	Cross hair line
	Screen rotation	±360°, fine feed and clamp
	Angle display(LED)	Resolution: 1' or 0.01°(switchable), Range: ±370°, Functions: Absolute/incremental mode switching, Zero set
Projection lens	Standard accessory: 10x(172-184), Optional accessories: 5X, 20X, 50X, 100X	
Magnification accuracy	Contour illumination	±0.1% or less
	Surface illumination	±0.15% or less
Contour illumination	light source	Halogen bulb (24V 150W)
	Optical system	Telecentric system
	Functions	2-step brightness switch, Heat-absorbing filter, Cooling fan
Surface illumination (Optional accessories)	light source	Halogen bulb(24V 150W)
	Functions	Adjustable condenser lens. Heat-absorbing filter, Cooling fan
	Table travel (X-axis)	10" / 254mm
XY Stage	Table size (X, Z)	17.7"x5.7" / 450x146mm
	Vertical travel (Y-axis)	6" / 152mm
Power supply	Resolution	0.001mm/.00005"*
	Measuring Unit	Built in Linear scale
	Max. workpiece width	See (L) on page I-10
Mass	Max. workpiece load	100lbs / 45kg
	Power supply	120V AC, 50/60Hz
Standard accessories	Mass	333lbs / 150kg
	Standard accessories	10x projection lens set, work stage, power cord, halogen bulb, tube fuse, grounding wire, allen wrench, Vinyl cover

* Counter not included

SYSTEM DIAGRAM

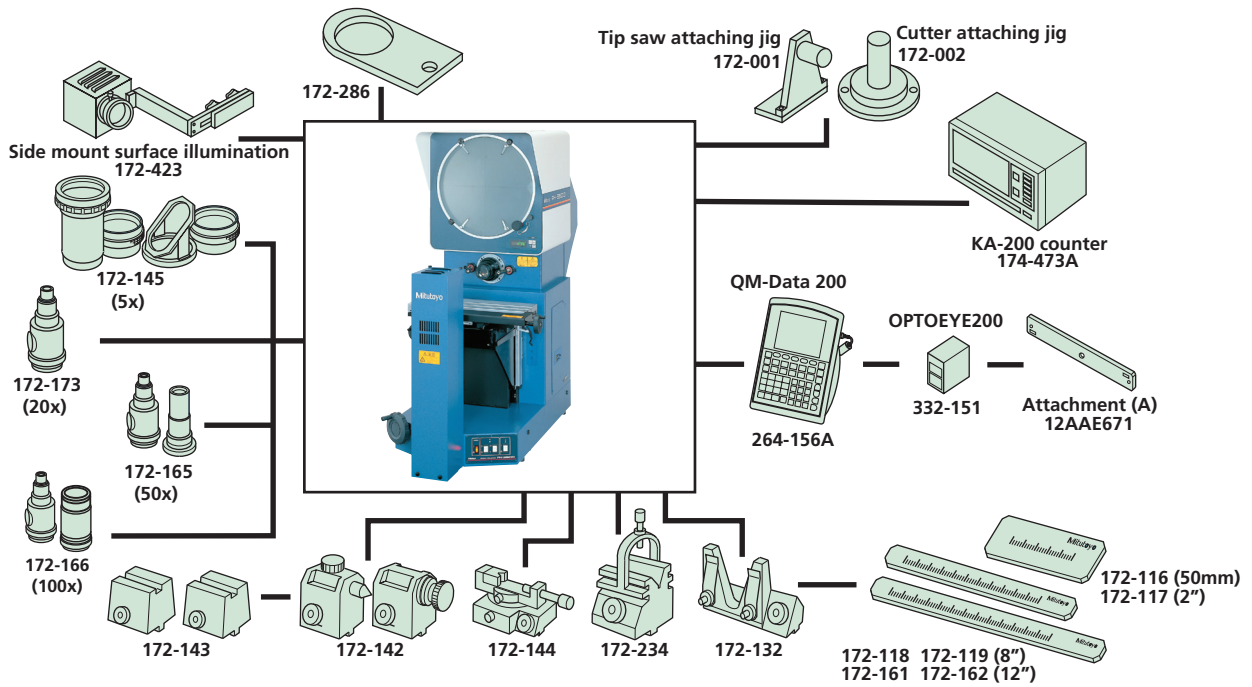

ACCESSORIES

Projection Lenses



Projection Capacity

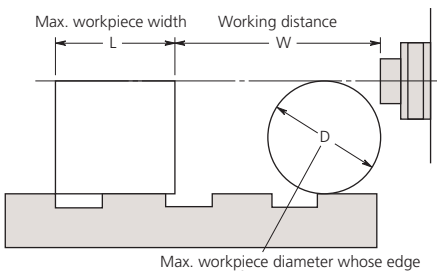

PH-3515F

Unit: mm

	Magnification				
	5X	10X	20X	50X	100X
View field	70.6	35.3	17.65	7.06	3.5
L	175	235	235	80	109
W	160 (64)	93 (35)	40	14.6	9.5
D	152.4	152.4	116	30.4	19

(): When using surface illumination

Workstage

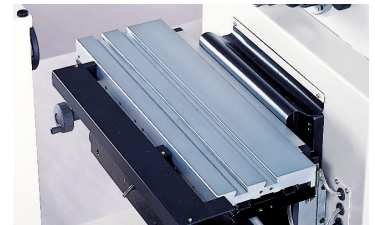

XY range	X-axis (horizontal travel): 10" (254mm)
Y-axis (vertical travel): 6" (152mm)	
Measuring unit	Linear Scale for each axis (AT100 Series)
Display unit	(Optional)
Stage size (WxD)	17.72"x5.75" (450x146mm)
Swivel range	±10° (30' readout)
Max. workpiece load	99 lbs. (45kg)
Dovetail groove	Two (Pitch= 1.69" (43mm))
Focusing travel	2" (50mm)

KA-200 Counter: 174-183A 64AAB149: Counter stand



QM-Data200 2-D data processing unit. 264-155A: Stand mount type 264-156A: Arm mount type



332-151: Optoeye Edge detection system for QM-Data 200 12AAE671: Detector attachment (A)

See page 4 for additional optional accessories

Optional Accessories

- 172-011: 10X projection lens (standard accessory)
- 172-012: 20X projection lens
- 172-013: 50X projection lens set
- 172-014: 100X projection lens set
- 172-116: Standard scale (50mm)
- 172-117: Standard scale (2")
- 172-118: Reading scale (200mm)
- 172-161: Reading scale (300mm)
- 172-119: Reading scale (8")
- 172-162: Reading scale (12")
- 172-286: Green filter
- 512305: Halogen bulb (24V, 150W) (standard accessory)

Fixture and Stage accessories

- 172-142: Center support
- 172-143: Center support riser
- 172-144: Rotary vise
(Max. workpiece dia.: 2.4" / 60mm)
- 172-234: V-block with clamp
(Max. workpiece dia.: 2" / 50mm)
- 172-132: Vertical holder
- 64AAB176: Machine stand 22"W x 25" D x 26"H

Stand

- 64AAB176
Locking door
22"W x 25"H x 29"D



Center Support

172-142



Clamps a cylindrical workpiece such as a screw
Workpiece dia.: 120mm max

Center Support Riser

172-143

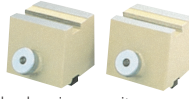

Widens the damping capacity of the center support to a maximum diameter of 240mm.

Reading Scales

- 172-118 (200mm)
 - 172-161 (300mm)
 - 172-119 (8")
 - 172-162 (12")
- Designed for checking the magnified image of a standard scale.



Rotary Vise

172-144

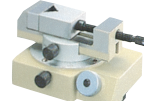

Workpiece dia.: 60mm max

Vertical Holder

172-132

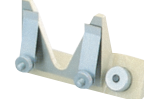

Set up a thin workpiece easily

Standard Scales

- 172-116 (50mm)
- 172-117 (2")



Used for checking magnifying accuracy.

V-Block w/ Clamp

172-234



Workpiece dia.: 50mm max

Green Filter

172-286

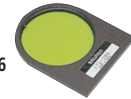

Increases the screen sharpness of the contour image.

Coordinate Measuring Machines	Vision Measuring Systems	Form Measurement	Optical Measuring
Sensor Systems	Test Equipment and Seismometers	Digital Scale and DRO Systems	Small Tool Instruments and Data Management

Whatever your challenges are, Mitutoyo supports you from start to finish.

Mitutoyo is not only a manufacturer of top-quality measuring products but one that also offers qualified support for the lifetime of the equipment, backed by comprehensive services that ensure your staff can make the very best use of the investment.

Apart from the basics of calibration and repair, Mitutoyo offers product and metrology training, as well as IT support for the sophisticated software used in modern measuring technology. We can also design, build, test and deliver measuring solutions and even, if deemed cost-effective, take your critical measurement challenges in-house on a sub-contract basis.



Find additional product literature and our product catalog

www.mitutoyo.com

Mitutoyo

Mitutoyo America Corporation

www.mitutoyo.com

One Number to Serve You Better

1-888-MITUTOYO (1-888-648-8869)

M³ Solution Centers:

- Aurora, Illinois (Headquarters)
- Boston, Massachusetts
- Huntersville, North Carolina
- Mason, Ohio
- Plymouth, Michigan
- City of Industry, California
- Birmingham, Alabama
- Renton, Washington
- Houston, Texas

Note: All information regarding our products, and in particular the illustrations, drawings, dimensional and performance data contained in this printed matter as well as other technical data are to be regarded as approximate average values. We therefore reserve the right to make changes to the corresponding designs. The stated standards, similar technical regulations, descriptions and illustrations of the products were valid at the time of printing. In addition, the latest applicable version of our General Trading Conditions will apply. Only quotations submitted by ourselves may be regarded as definitive. Specifications are subject to change without notice.

Mitutoyo products are subject to US Export Administration Regulations (EAR). Re-export or relocation of our products may require prior approval by an appropriate governing authority.

Trademarks and Registrations

Designations used by companies to distinguish their products are often claimed as trademarks. In all instances where Mitutoyo America Corporation is aware of a claim, the product names appear in initial capital or all capital letters. The appropriate companies should be contacted for more complete trademark and registration information.