

APEX[®]

Fastener Drive Tools



Table of Contents

Introduction	IV
Bits	
Phillips	1
Slotted	6
Torx®	10
Torx Plus®	12
Pozidriv®	13
Sel-O-Fit®	14
Quadrex®	14
Frearson	15
B.N.A.E.	15
Socket Head	16
Square Recess.	18
Pipe Plug Inserts	20
Torq-Set®	21
Mor Torq®	21
Tri-Wing®	22
Hi-Torque®	23
Triple Square	23
Bit Holders	
Hex Drive	25
Female Square Drive	26
Hand Drivers	
Replaceable Bit	28
Awls	28
Hex Drive Nutsetters, Extensions & Universal Wrenches	
Nutsetters	27
Extensions	29
Universal Wrenches	31
1/4" Drive Sockets, Extensions, Adapters & Universal Wrenches	
SAE Sockets and Universal Wrenches ...	35
Metric Sockets and Universal Wrenches ...	37
Spline and Torx® Sockets	38
Extensions and Adapters	39
3/8" Drive Sockets, Extensions, Adapters & Universal Wrenches	
SAE Sockets & Universal Wrenches	40
Metric Sockets & Universal Wrenches ...	44
Spline & Torx® Sockets	47
Extensions & Adapters	47

1/2" Drive Sockets, Extensions, Adapters & Universal Wrenches	
SAE Sockets & Universal Wrenches	48
Metric Sockets & Universal Wrenches ...	54
Spline & Torx® Sockets	58
Extensions & Adapters	58
5/8" Drive Sockets, Extensions, Adapters & Universal Wrenches	
SAE Sockets & Universal Wrenches	60
Metric Sockets	61
Extensions & Adapters	61
3/4" Drive Sockets, Extensions, Adapters & Universal Wrenches	
SAE Sockets & Universal Wrenches	62
Metric Sockets	64
Extensions & Adapters	64
1" Drive Sockets, Extensions & Adapters	
SAE Sockets & Budd Wheel Sockets ...	65
Metric Sockets	66
Extensions & Adapters	66
1 1/2" Drive SAE Sockets & Adapters	67
2 1/2" Drive SAE Sockets & Adapters	67
Anti-Mar Protective Covers	
µ-Guard	68
Engineered Solutions	72
Special Sockets, Adapters & Accessories	
Reversible Sockets	74
Valve Stem Drivers	74
Ferry Cap® Sockets	74
Tap Holding Sockets	74
Grease Fitting Sockets	75
Drill Holders	75
Extensions & Adapters, Universal	
Wrenches & Budd Wheel Sockets	75
Socket Retaining Rings	76
Adapters	76
Quotation Worksheets	78
Part Number Index	81

Quick Reference

	Bits	1 – 24
	Bit Holders	25 – 26
	Hand Drivers	28
	Hex Drive Nutsetters, Extensions & Universal Wrenches	27 – 31
	1/4" Sockets, Extensions, Adapters & Universal Wrenches	35 – 39
	3/8" Sockets, Extensions, Adapters & Universal Wrenches	40 – 48
	1/2" Sockets, Extensions, Adapters & Universal Wrenches	49 – 59
	5/8"-2 1/2" Sockets, Extensions, Adapters & Universal Wrenches	60 – 67
	Anti-Mar Protective Covers	68– 72
	Special Sockets, Adapters & Accessories	74 – 77
	Part Number Index	81 – 89

The Apex heritage of quality, delivery and support.

For more than half a century Apex has maintained a position of leadership in industrial fastening tools. Today, Apex stands ready to improve the productivity of assembly operations around the world with unsurpassed tool performance and customer service.

Precision Fit

Apex quality begins with select raw materials. Only carefully chosen, high grade tool steel is used. Each tool is manufactured to the tightest tolerances in the industry...most are even tighter than licensing agreement requirements. Our bits meet the most stringent government and military specifications where applicable (ie. MIL-B-9946/5 for HTS Hi-Torque® bits used in aerospace assembly).

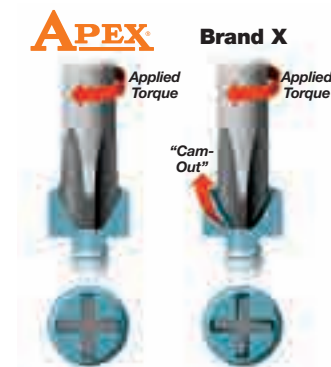

Precision fit of Apex tools eliminates "cam-out" and premature bit failure.

Apex sockets, nutsetters and universal wrenches have hex tolerances that are on average 48% tighter than DIN and 35% tighter than ANSI requirements. With Apex you are assured of an exact, sure fit.

All Apex sockets and extensions have the tightest tolerances for straightness and concentricity in the



industry. Tools that run true perform better and last longer.

Lasting Performance

Each Apex tool is tempered with our proprietary heat treating process that lets you select the degree of hardness your particular application requires. Choose from tough, non-brittle durability that stands up to torque, to the hardest heat treat available in the industry for the ultimate in wear resistance.

Apex offers a choice of three heat treat hardness levels in many of our screwdriver bits to match the application. These heat treats are specified by a letter suffix as follows:

- X - Hardest heat treat in the industry**
- I - Intermediate hardness**
- R - Lowest hardness**

Our experienced staff can help in selecting the best heat treat for your particular application.



Apex bits & sockets last ten times longer than most of our competitors.

Innovative Solutions

Throughout our history Apex has partnered with the leading fastener manufacturers to assist in the development of new fastening technologies. Today, many of these new tools that are now common can trace their history back to Apex engineering.

Recently Apex introduced **μ-Guard** protective covers to satisfy the growing demand for products that prevent in-system damage.



Unsurpassed Offering

This catalog contains 3,000+ of the most frequently requested bits, sockets and fastening accessories. Our entire active offering approaches 10,000 sellable part numbers. If the tool you need does not appear in this catalog, give us a call. The odds are, we may have what you need as a non-catalog item. If not, our



experienced staff of tooling experts can design and manufacture "specials" to meet the needs of your specific applications. You can even submit special requests on-line at our website www.apex-tools.com by completing the simple forms.

This flexibility has helped make Apex the only manufacturer which is a market and technology leader in all of the following industrial product categories: Bits & Bit Holders, Impact Sockets, Extensions and Universal Wrenches.

Availability & Service

Apex has approximately 2,000 authorized distributor locations globally to provide product off-the-shelf as well as knowledgeable service and support. Apex stocks over 1,000 part numbers and a multitude of blanks to manufacture several thousand more in order to support our strong global distribution network.



Important Notes

User safety tips

- Always wear safety glasses when using any tool.
- Always visually inspect tool for damage and cracking. Immediately replace all damaged tools.
- Do not modify or alter any tool.
- Do not use tools beyond their limit or useful life.
- Contact Apex for the recommended operating torque of any tool.

Selecting the proper heat treat for bits

Choosing the proper heat treat for screwdriver tools is important in achieving long tool life. Different applications, different operators, and different power tools require different heat treats. Apex offers a choice of three heat treat hardness levels in many of our screwdriver bits to match the particular customer's application. These heat treats are specified by a letter suffix as follows:

- X - The hardest heat treat in the industry**
- I - Intermediate hardness**
- R - Lowest hardness**

Selecting the proper heat treat best suited for a particular application may require some trial and error. The proper heat treat depends on the failure mode. If the bit breaks or shatters, select a bit with less hardness. If the failure mode is wear, select a harder bit. Many times both breakage and wear may occur within the same application. This can be due to a number of factors such as a different operators, different torque values, and different power tool settings. In general, high torque applications require "R" heat treats to withstand twisting and resist breakage. The "X" heat treat is most suitable for low torque applications, particularly if hardened screws are used.

If a failure occurs, a change in hardness may result in better service. The "X" heat treat is most common and should be selected unless the specifics of an application or an existing problem would suggest using "I" or "R" hardness.

To specify a particular heat treat, add a letter suffix to the part number. For example, to specify "X" hardness in a #2 Phillips insert, the part number would be 440-2X. Not all Apex bits are available in all heat treats. Special heat treats can be supplied for a particular application. Contact your Apex representative for specific recommendations.

Since "X" hardness is the most popular with our customers, it is our default product where "X" designation may omitted from the part number. For all other hardness designations, the product packaging will be marked with the appropriate hardness designation letter.

Warning

- Using any adapter may result in a torque overload and failure in the adapter, socket or fastener.
- Do not use thin wall sockets with impact power tools.

Warning

- Using any adapter may result in a torque overload and failure in the adapter, socket or fastener.
- Do not use thin wall sockets with impact power tools.
- Do not use universal wrenches with impact power tools.

APEX® Solutions

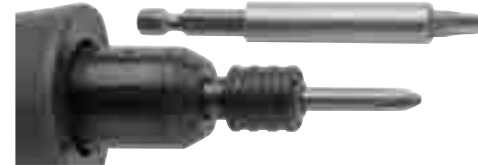

What's the difference between an insert and a power bit?

Insert bits are commonly used with a bit holder in power tool applications. This combination is economical, provides flexibility and allows a fastener to be magnetically held by the bit. Power bits are placed directly into the power tool chuck. See pages 25-26 for a complete listing of Apex bit holders.



What's the advantage of reduced diameter bits?

Reduced diameter bits are ideal for driving screws below the surface of drywall.

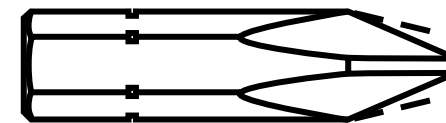

What's the advantage of 27 Series bits?

27 Series bits are ideal for poorly recessed Phillips screws. A wider tip design fills out an inexact recess to make better contact.



Why do Apex bits last so much longer?

Apex's premium tool alloys and proprietary heat treat help avoid typical problems

such as shattering and premature bit wear. Most Apex bits are available in three different heat treat hardnesses.

Refer to page vi for information on selecting the proper heat treat.

What's the advantage of Apex® ACR® bits?

Painted, coated or corroded fasteners can present special problems. Apex® ACR® insert bits' special wing-face ribs grip screw recesses to reduce stripping and cam-out which can result in damage to the surrounding workpiece. Choose from bits ribbed for screw removal, driving or both. They're also available in both insert bits and power drives.

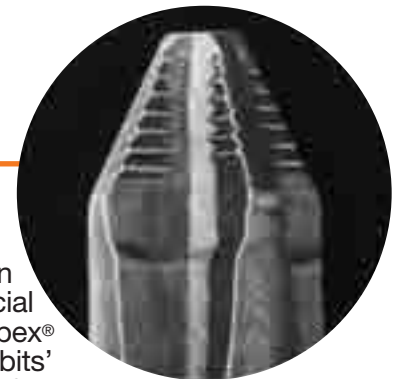

If the tool you need does not appear in this catalog, give us a call. The odds are, we may have what you need as a non-catalog item. If not, our experienced staff of tooling experts can design and manufacture "specials" to meet the needs of your specific application. Give us a call at 1-800-845-5629 or visit our website www.apex-tools.com.

In this section...

Insert and Power Drive Bits



For all these fastener styles:

- Phillips®
- Slotted
- Torx®
- Torx Plus®
- Torx® Tamper Resistant
- Torx Plus® Tamper Resistant
- Poizidriv®
- Sel-o-fit®
- Quadrex®
- Frearson
- B.N.A.E.
- Socket Head
- Square Recess
- Torq-Set®
- MorTorq®
- Tri-Wing®
- Hi-Torque®
- Triple Square

Bit Holders, Nutsetters, Extensions and Universal Wrenches



Bit holders adapt hex drive and female square drive power tools to a variety of insert bits. Hex drive nutsetters, extensions and universal wrenches allow nutrunning in all types of applications.

Selecting the correct Phillips point size

Apex bits in these five point sizes will drive ANY Phillips screw

Point Size	Wood Screws Body Dia.	Flat, Oval, Round	Flat, Oval, Binding	Machine Screws Round, Fillister	Truss, Brazier, Button	Sheet Metal Screws Flat, Round, Oval, Stove, Binding
0	0	0	0	0	0	
1	3/16	2	2	2	2	2
	3	3	3	3	3	
	4	4	4	4	4	
2	1/4	5	5	5	5	5
	6	6	6	6	8	6
	7	7	8	8	10	7
	8	8	10	10	8	
	9	9	10			
3	10					
	5/16	10	12	12	12	12
	12	14	1/4	1/4	1/4	14
	14	16	5/16			
4	16					
	3/8	18	18	5/16	3/8	5/16
	20	20	3/8	7/16	3/8	
	24	24	7/16	1/2	7/16	
1/2	1/2					

IMPORTANT The table above will enable you to determine the Phillips point size required for any Phillips screws or bolts. The No. 2 and No. 3 point sizes cover the range of Phillips screws most commonly used. The Apex Phillips bits on the following pages are available in point sizes to drive any Phillips screw.

Phillips Bits

1/4" Hex Insert Bits

Part Number	Point Size	Overall Length	
		In.	mm
440-1X	1	1	25
440-115X	1	1 1/2	38
440-12X	1	2	51
440-125X	1	2 1/2	64
440-13X	1	3	76
440-2X	2	1	25
440-2I	2	1	25
440-215X	2	1 1/2	38
440-22X	2	2	51
440-225X	2	2 1/2	64
440-23X	2	3	76
440-24X	2	4	101
440-255X	2	5 1/2	140
440-26X	2	6	152
440-27X*	2	1	25
440-3X	3	1	25
440-3I	3	1	25
440-3125X	3	1 1/4	32
440-3BNX	3	1 1/4	32
440-32X	3	2	51
440-325X	3	2 1/2	64
440-33X	3	3	76
440-34X	3	4	101
440-4X	4	1 5/16	33

*For shallow screw recesses. See Tool Tip on page 7

1/4" Hex Insert Bits – Limited Clearance

Part Number	Point Size	Overall Length		Turned Length (A)		Turned OD (B)	
		In.	mm	In.	mm	In.	mm
446-0X	0	1	25	7/16	11	0.170	4.06
446-1X	1	1	25	7/16	11	0.170	4.06
446-12X	1	2	51	7/16	11	0.170	4.06
SD-1055-A	1	2	51	1 3/8	35	0.170	4.06
446-2X	2	1	25	7/16	11	0.170	4.06
446-2I	2	1	25	7/16	11	0.170	4.06
446-215X	2	1 1/2	38	7/16	11	0.170	4.06
446-22X	2	2	51	7/16	11	0.170	4.06
446-215T	2	1 1/2	38	1	25	0.170	4.06
446-22TX	2	2	51	1 1/2	38	0.170	4.06
446-225T	2	2 1/2	64	1 3/4	44	0.170	4.06
446-23T	2	3	76	2 1/4	57	0.170	4.06
446-27X*	2	1	25	7/16	11	0.170	4.06

*For shallow screw recesses see Tool Tip on page 5.

1/4" Hex Insert Bits – ACR®

Part Number	Point Size	Overall Length	
		In.	mm
440-1-ACR1-RX	1	1	25
440-1-ACR1-DX	1	1	25
440-1-ACR1X	1	1	25
440-2-ACR2-RX	2	1	25
440-2-ACR2-RI	2	1	25
440-2-ACR2-DX	2	1	25
440-2-ACR2X	2	1	25
446-2-ACR2-DX	2	1	25
440-22-ACR2-RX	2	2	51
440-22-ACR2-DX	2	2	51
440-22-ACR2X	2	2	51
440-3-ACR3-RX	3	1	25
440-3-ACR3-DX	3	1	25
440-3-ACR3X	3	1	25

Part number suffix -R For removal Part number suffix -D For driving No part number suffix For both removal and driving

5/16" Hex Insert Bits

Part Number	Point Size	Overall Length	
		In.	mm
480-1X	1	1 1/4	32
480-2X	2	1 1/4	32
480-22X	2	2	51
480-225X	2	2 1/2	64
480-24X	2	4	101
480-3X	3	1 1/4	32
480-325X	3	2 1/2	64
480-34X	3	4	101
480-4X	4	1 1/4	32
480-4BNX	4	1 1/2	38
480-425X	4	2 1/2	64

5/16" Hex Insert Bits – ACR®

Part Number	Point Size	Overall Length	
		In.	mm
480-2-ACR2-RX	2	1 1/4	32
480-2-ACR2X	2	1 1/4	32
480-3-ACR3X	3	1 1/4	32
480-4-ACR4X	4	1 1/4	32

Part number suffix -R For removal Part number suffix -D For driving No part number suffix For both removal and driving

ACR® is a trademark of the Phillips Screw Co.

Phillips Bits (+)

5/16" Square Insert Bits



Part Number	Point Size	Overall Length	
		In.	mm
830-1X	1	1 1/8	29
830-2X	2	1 1/8	29
830-3X	3	1 1/8	29
830-4X	4	1 1/8	29



1/4" Hex Power Drive



Part Number	Point Size	Overall Length		Body Diameter		Turned Length	
		In.	mm	In.	mm	In.	mm
4910X	0	1 15/16	49	1/8	3.2	1 1/4	32
4910-AX	0	2 3/4	70	1/8	3.2	2	51
4910-BX	0	3 1/2	89	1/8	3.2	2 3/4	70
4910-CX	0	6	152	1/8	3.2	2	51
491X	1	1 15/16	49	3/16	4.8	1 1/4	32
491-AX	1	2 3/4	70	3/16	4.8	2	51
491-BX	1	3 1/2	89	3/16	4.8	2 3/4	70
491-CX	1	6	152	3/16	4.8	2	51
491-CCX	1	6	152	3/16	4.8	5 1/4	133
492X	2	1 15/16	49	1/4	6.4	1 1/4	32
492I	2	1 15/16	49	1/4	6.4	1 1/4	32
492-AX	2	2 3/4	70	1/4	6.4	2	51
492-AI	2	2 3/4	70	1/4	6.4	2	51
492-BX	2	3 1/2	89	1/4	6.4	2 3/4	70
492-BI	2	3 1/2	89	1/4	6.4	2 3/4	70
492-CX	2	6	152	1/4	6.4	2	51
492-CI	2	6	152	1/4	6.4	2	51
492-200MM	2	7 13/16	200	1/4	6.4	7	178
SD-2052-8	2	8	203	9/32	7.1	7	178
SD-2052-10	2	10	254	9/32	7.1	9	229
492-CCX	2	6	152	1/4	6.4	5 1/4	133
492-27X*	2	1 15/16	49	1/4	6.4	1 1/4	32
492-A-27X*	2	2 3/4	70	1/4	6.4	2	51
492-B-27X*	2	3 1/2	89	1/4	6.4	2 3/4	70
492-C-27X*	2	6	152	1/4	6.4	2	51
492-CC-27X*	2	6	152	1/4	6.4	5 1/4	133
493X	3	1 15/16	49	5/16	7.9	1	25
493-AX	3	2 3/4	70	5/16	7.9	1 3/4	44
493-BX	3	3 1/2	89	5/16	7.9	2 1/2	64
493-CX	3	6	152	5/16	7.9	5	127
4930X	3	1 15/16	49	1/4	6.4	1 1/4	32
4930-AX	3	2 3/4	70	1/4	6.4	2	51
4930-BX	3	3 1/2	89	1/4	6.4	2 3/4	70
4930-CX	3	6	152	1/4	6.4	2	51
4930-CCX	3	6	152	1/4	6.4	5 1/4	133
494X	4	1 15/16	49	3/8	9.5	1	25

* For shallow screw recesses. See Tool Tip on page 5.



1/4" Hex Power Drive – ACR®

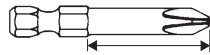

Part Number	Point Size	Overall Length		Body Diameter		Turned Length	
		In.	mm	In.	mm	In.	mm
491-ACR1-RX	1	1 15/16	49	3/16	4.8	1 1/4	32
491-ACR1-DX	1	1 15/16	49	3/16	4.8	1 1/4	32
491-ACR1X	1	1 15/16	49	3/16	4.8	1 1/4	32
492-ACR2-RX	2	1 15/16	49	1/4	6.4	1 1/4	32
492-ACR2-DX	2	1 15/16	49	1/4	6.4	1 1/4	32
492-ACR2X	2	1 15/16	49	1/4	6.4	1 1/4	32
492-A-ACR2-DX	2	2 3/4	70	1/4	6.4	2	51
492-A-ACR2X	2	2 3/4	70	1/4	6.4	2	51
492-B-ACR2-DX	2	3 1/2	89	1/4	6.4	2 3/4	70
492-B-ACR2X	2	3 1/2	89	1/4	6.4	2 3/4	70
492-C-ACR2-DX	2	6	152	1/4	6.4	2	51
493-ACR3X	3	1 15/16	49	5/16	7.9	1	25

Part number suffix -R
For removal



Part number suffix -D
For driving



No part number suffix
For both removal and driving



1/4" Hex Power Drive with Finder Sleeve



Part Number	Point Size	Overall Length		Sleeve Diameter	
		In.	mm	In.	mm
SD-556-A	2	3 1/2	89	7/16	11.1
SD-556	2	6	152	7/16	11.1



7/16" Hex Power Drive

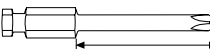

Part Number	Point Size	Overall Length		Body Diameter		Turned Length	
		In.	mm	In.	mm	In.	mm
482X	2	3 1/2	89	1/4	6.4	2 1/4	57
483X	3	3 1/2	89	5/16	7.9	2 1/4	57
484X	4	3 1/2	89	3/8	9.5	2 1/4	57



9/32" No. 130A Yankee Drive

Part Number	Point Size	Overall Length		Body Diameter	
		In.	mm	In.	mm
451X	1	3 1/4	83	3/16	4.8
452X	2	3 1/4	83	9/32	7.1
453X	3	3 1/4	83	5/16	7.9

ACR® is a trademark of the Phillips Screw Co.

Phillips Bits (+)

10-32 Screw Shank Drive

Part Number	Point Size	Overall Length		Body Diameter	
		In.	mm	In.	mm
501X	1	1 1/2	38	3/16	4.8
501-AX	1	1 13/16	46	3/16	4.8
502X	2	1 1/2	38	1/4	6.4
502-ACR2X*	2	1 1/2	38	1/4	6.4
SD-1342-2	2	1 3/4	45	1/4	6.4
502-AX	2	1 13/16	46	1/4	6.4
503X	3	1 1/2	38	5/16	7.9

*Features ACR® anti-camout ribs. See Tool Tip on page 3.

12-24 Screw Shank Drive



Part Number	Point Size	Overall Length		Body Diameter	
		In.	mm	In.	mm
551X	1	1 3/16	30	.30	7.6
552X	2	1 3/16	30	.30	7.6
552I	2	1 3/16	30	.30	7.6
553X	3	1 3/16	30	.30	7.6

1/4"-24 Screw Shank Drive



Part Number	Point Size	Overall Length		Body Diameter	
		In.	mm	In.	mm
401X	1	1 1/2	38	3/16	4.8
402X	2	1 1/2	38	1/4	6.4
403X	3	1 1/2	38	5/16	7.9

8-32 Screw Shank Drive



Part Number	Point Size	Overall Length		Body Diameter	
		In.	mm	In.	mm
591X	1	1 3/16	30	7/32	5.6
592X	2	1 3/16	30	7/32	5.6

Female Square Service Drive



Part Number	Female Square Drive	Point Size	Overall Length		Body Diameter	
			In.	mm	In.	mm
821	1/4	1	2	51	1/4	6.4
822	1/4	2	2	51	1/4	6.4
832	3/8	2	2 5/8	67	5/16	7.9
833	3/8	3	2 5/8	67	5/16	7.9
834	3/8	4	2 5/8	67	5/16	7.9
852	1/2	2	2 7/8	73	5/16	7.9
853	1/2	3	2 7/8	73	5/16	7.9
854	1/2	4	2 7/8	73	3/8	9.5

If the tool you need does not appear in this catalog, give us a call. The odds are, we may have what you need as a non-catalog item. If not, our experienced staff of tooling experts can design and manufacture "specials" to meet the needs of your specific application. Give us a call at 1-800-845-5629 or visit our website www.apex-tools.com.

APEX Solutions

Does Apex offer Torx® bits?

Torx® fasteners are becoming more and more common in automotive and appliance assembly. Apex provides a full selection of bits for Torx screws.

(See page 10)

Torx® is a trademark of the Camcar Division of Textron.



Is there an easy way to select a bit?

Take the guesswork out of bit selection. Apex Phillips and Torx® ring gauges help you find the right bit for your fasteners. Order SD-3749 for Phillips and SD-4064-G for Torx®.

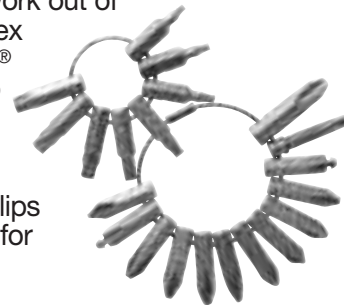

What is a finder sleeve?

A finder sleeve makes it easy to engage slotted fasteners with the bit. It guides the bit so there is less "searching" for the proper alignment between blade and slot.



(See page 9)

If the tool you need does not appear in this catalog, give us a call. The odds are, we may have what you need as a non-catalog item. If not, our experienced staff of tooling experts can design and manufacture "specials" to meet the needs of your specific application. Give us a call at 1-800-845-5629 or visit our website www.apex-tools.com.

Why do Apex bits last so much longer than other bits?

Apex's premium tool alloys and proprietary heat treat help avoid typical problems such as shattering and premature bit wear. Most Apex bits are available in three different heat treat hardnesses. Refer to page vi for information on selecting the proper heat treat.



What's the difference between Torx® and Torx Plus® bits?

Torx Plus® bits and fasteners feature a greater engagement area for higher torque transfer and reduced camout when driving Torx Plus® fasteners. They can provide up to 100% more drive cycles.

Torx Plus® bits are not compatible with standard Torx® fasteners.

(See pages 10-12)



Regular Torx®

Torx Plus® is a trademark of Acument Intellectual Properties, LLC. Torx Plus® Tamper Resistant Bits are available on a limited basis. Please contact your Area Distributor or Representative for more details.

Does Apex offer mar resistant bits and sockets?

Apex can nylon coat just about any of our bits or sockets. Nylon offers excellent mar resistance for assemblies that have painted, varnished or chromed surfaces. Nylon also offers some safety benefits by covering tool junctions.

(See pages 68-72 for more information)



Does Apex offer fastener tools for the aircraft industry?

Apex offers a full selection of fastener tools common to aircraft assembly and maintenance, including Tri-Wing®, Torq-Set®, Hi-Torque® and Phillips.

(See pages 21-22)



Torq-Set® and ACR® are registered trademarks of the Phillips Screw Co.

How do Torxalign® bits work?

Torxalign® bits "wedge" into the Torx® recess to firmly hold the fastener to the bit.



(See page 11)

What's the difference between a Phillips and a Pozidriv® screw?

The shallow "cross" indentation in the screw head identifies a Pozidriv® fastener. The Pozidriv® bit and recess design provides contact than a standard Phillips for more torque with less possibility of camout.



(See page 13)

Slotted Screw Sizes

Types of Heads

Note: When ordering slotted bits, please remember that head sizes and slot widths of hardened, self tapping, and sheet metal screws do not conform to the same specifications as standard wood or machine screws described in the chart below. Also, because of variations in these dimensions among screws from different manufacturers, bits should be ordered to head and slot size rather than screw size.

Screw Sizes	Diameter of Head		Round Head		Truss Head	Binding Head	Fillister Cap Mach.	Pan Head	Width of slot
	Flat Head Wood	Oval Head Mach.	Wood	Mach.					
1	.146 .130	.146 .130	.138 .122	.138 .122			.118 .104		.026 .019
2	.172 .156	.172 .156	.162 .146	.162 .146	.194 .180	.181 .171	.140 .124	.167 .155	.031 .023
3	.199 .181	.199 .181	.187 .169	.187 .169	.226 .211	.208 .197	.161 .145	.193 .180	.035 .027
4	.225 .207	.225 .207	.211 .193	.211 .193	.257 .241	.235 .223	.183 .166	.219 .205	.039 .031
5	.252 .232	.252 .232	.236 .217	.236 .217	.289 .272	.263 .249	.205 .187	.245 .231	.043 .035
6	.279 .257	.279 .257	.260 .240	.260 .240	.321 .303	.290 .275	.226 .208	.270 .256	.048 .039
7	.305 .283		.285 .264		.352 .333			.296 .281	.048 .039
8	.332 .308	.332 .308	.309 .287	.309 .287	.384 .364	.344 .326	.270 .250	.322 .306	.054 .045
9	.358 .334		.334 .311					.296 .281	.054 .045
10	.385 .359	.385 .359	.359 .334	.359 .334	.448 .425	.339 .378	.313 .292	.373 .357	.060 .050
12	.438 .410	.438 .410	.408 .382	.408 .382	.511 .487	.454 .430	.357 .334	.425 .407	.067 .056
14	.491 .461		.457 .424					.296 .281	.075 .064
1/4"	.507 .477		.472 .443		.573 .546	.513 .488	.375 .363	.492 .473	.075 .064
16	.544 .512		.506 .476					.296 .281	.075 .064
18	.597 .563		.555 .523					.296 .281	.084 .072
5/16"	.635 .600		.590 .557		.698 .666	.641 .609	.437 .424	.615 .594	.084 .072
20	.650 .614		.604 .570					.296 .281	.084 .072
24	.756 .716		.702 .664					.296 .281	.094 .081
3/8"	.762 .722		.708 .670		.823 .787	.769 .731	.562 .547	.740 .716	.094 .081

Slotted Bits



1/4" Hex Insert Bits – Limited Clearance



Part Number	Screw Size	Length		Blade Thickness		Blade Width	
		In.	mm	In.	mm	In.	mm
445-000X	1F-2R	1	25	.021	.53	.125	3.2
445-00X	2F-3R	1	25	.025	.64	.140	3.6
445-0X	3F-4R	1	25	.030	.76	.154	3.9
445-10X	4F-5R	1	25	.034	.86	.185	4.7
445-20X	5F-6R	1	25	.036	.91	.216	5.5
445-30X	6F-7R	1	25	.038	.97	.248	6.3
445-00-15X	2F-3R	1 1/2	38	.028	.71	.138	3.5
445-0-15X	3F-4R	1 1/2	38	.032	.81	.154	3.9
445-10-15X	4F-5R	1 1/2	38	.034	.86	.185	4.7
445-20-15X	5F-6R	1 1/2	38	.036	.91	.216	5.5
445-30-15X	6F-7R	1 1/2	38	.038	.97	.248	6.3



1/4" Hex Insert Bits



Part Number	Screw Size	Length		Blade Thickness		Blade Width	
		In.	mm	In.	mm	In.	mm
445-1X	4F-5R	1	25	.034	.86	3/16	4.8
445-2X	6F-8R	1	25	.040	1.02	7/32	5.6
445-3X	8F-10R	1	25	.042	1.07	1/4	6.4
445-4X	10F-12R	1	25	.046	1.17	9/32	7.1
445-1-15X	4F-5R	1 1/2	38	.034	.86	3/16	4.8
445-2-15X	6F-8R	1 1/2	38	.040	1.02	7/32	5.6
445-3-15X	8F-10R	1 1/2	38	.042	1.07	1/4	6.4
445-4-15X	10F-12R	1 1/2	38	.046	1.17	9/32	7.1
445-5X	12F-14R	1 1/2	38	.050	1.27	5/16	7.9
445-6X	14F-16R	1 1/2	38	.055	1.40	23/64	9.1



5/16" Hex Insert Bits



Part Number	Screw Size	Length		Blade Thickness		Blade Width	
		In.	mm	In.	mm	In.	mm
485-1X	4F-5R	1 1/2	38	.034	.86	3/16	4.8
485-2X	6F-8R	1 1/2	38	.040	1.02	7/32	5.6
485-3X	8F-10R	1 1/2	38	.042	1.07	1/4	6.4
485-4X	10F-12R	1 1/2	38	.046	1.17	.296	7.52
485-5X	12F-14R	1 1/2	38	.050	1.27	.328	8.33
485-6X	14F-16R	1 1/2	38	.055	1.40	.328	8.33
485-7X	16F-18R	1 3/4	45	.060	1.52	1/2	12.7



1/4" Hex Power Drive



Part Number	Screw Size	Length		Blade Thickness		Blade Width/ Body Diameter	
		In.	mm	In.	mm	In.	mm
320-000X	1F-2R	1 15/16	49	.022	.56	.122	3.10
326-000X	1F-2R	2 3/4	70	.022	.56	.122	3.10
323-000X	1F-2R	3	76	.022	.56	.122	3.10
327-000X	1F-2R	3 1/2	89	.022	.56	.122	3.10
324-000X	1F-2R	4	102	.022	.56	.122	3.10
325-000X	1F-2R	5	127	.022	.56	.122	3.10
328-000X	1F-2R	6	152	.022	.56	.122	3.10
320-00X	2F-3R	1 15/16	49	.026	.66	.134	3.40
326-00X	2F-3R	2 3/4	70	.026	.66	.134	3.40
323-00X	2F-3R	3	76	.026	.66	.134	3.40
327-00X	2F-3R	3 1/2	89	.026	.66	.134	3.40
324-00X	2F-3R	4	102	.026	.66	.134	3.40
325-00X	2F-3R	5	127	.026	.66	.134	3.40
328-00X	2F-3R	6	152	.026	.66	.134	3.40
320-0X	3F-4R	1 15/16	49	.030	.76	.151	3.84
326-0X	3F-4R	2 3/4	70	.030	.76	.151	3.84
323-0X	3F-4R	3	76	.030	.76	.151	3.84
327-0X	3F-4R	3 1/2	89	.030	.76	.151	3.84
324-0X	3F-4R	4	102	.030	.76	.151	3.84
325-0X	3F-4R	5	127	.030	.76	.151	3.84
328-0X	3F-4R	6	152	.030	.76	.151	3.84
320-1X	4F-5R	1 15/16	49	.034	.86	.187	4.75
326-1X	4F-5R	2 3/4	70	.034	.86	.187	4.75
323-1X	4F-5R	3	76	.034	.86	.187	4.75
327-1X	4F-5R	3 1/2	89	.034	.86	.187	4.75
324-1X	4F-5R	4	102	.034	.86	.187	4.75
325-1X	4F-5R	5	127	.034	.86	.187	4.75
328-1X	4F-5R	6	152	.034	.86	.187	4.75
320-20X	5F-6R	1 15/16	49	.036	.91	.215	5.46
326-20X	5F-6R	2 3/4	70	.036	.91	.215	5.46
323-20X	5F-6R	3	76	.036	.91	.215	5.46
327-20X	5F-6R	3 1/2	89	.036	.91	.215	5.46
324-20X	5F-6R	4	102	.036	.91	.215	5.46
325-20X	5F-6R	5	127	.036	.91	.215	5.46
328-20X	5F-6R	6	152	.036	.91	.215	5.46
320-2X	5F-6R	1 15/16	49	.036	.91	.250	6.35
326-2X	5F-6R	2 3/4	70	.036	.91	.250	6.35
323-2X	5F-6R	3	76	.036	.91	.250	6.35
327-2X	5F-6R	3 1/2	89	.036	.91	.250	6.35
324-2X	5F-6R	4	102	.036	.91	.250	6.35
328-2X	5F-6R	6	152	.036	.91	.250	6.35
320-3X	6F-8R	1 15/16	49	.038	.97	.250	6.35
326-3X	6F-8R	2 3/4	70	.038	.97	.250	6.35
323-3X	6F-8R	3	76	.038	.97	.250	6.35
327-3X	6F-8R	3 1/2	89	.038	.97	.250	6.35
324-3X	6F-8R	4	102	.038	.97	.250	6.35
325-3X	6F-8R	5	127	.038	.97	.250	6.35
328-3X	6F-8R	6	152	.038	.97	.250	6.35
320-4X	8F-10R	1 15/16	49	.042	1.07	.275	6.99
326-4X	8F-10R	2 3/4	70	.042	1.07	.275	6.99
323-4X	8F-10R	3	76	.042	1.07	.275	6.99
327-4X	8F-10R	3 1/2	89	.042	1.07	.275	6.99
324-4X	8F-10R	4	102	.042	1.07	.275	6.99
325-4X	8F-10R	5	127	.042	1.07	.275	6.99
328-4X	8F-10R	6	152	.042	1.07	.275	6.99
320-5X	10F-12R	1 15/16	49	.046	1.17	.312	7.92
326-5X	10F-12R	2 3/4	70	.046	1.17	.312	7.92
323-5X	10F-12R	3	76	.046	1.17	.312	7.92
327-5X	10F-12R	3 1/2	89	.046	1.17	.312	7.92
324-5X	10F-12R	4	102	.046	1.17	.312	7.92
325-5X	10F-12R	5	127	.046	1.17	.312	7.92
328-5X	10F-12R	6	152	.046	1.17	.312	7.92
320-6X	12F-14R	1 15/16	49	.050	1.27	.360	9.14
326-6X	12F-14R	2 3/4	70	.050	1.27	.360	9.14
323-6X	12F-14R	3	76	.050	1.27	.360	9.14
327-6X	12F-14R	3 1/2	89	.050	1.27	.360	9.14
324-6X	12F-14R	4	102	.050	1.27	.360	9.14
325-6X	12F-14R	5	127	.050	1.27	.360	9.14
328-6X	12F-14R	6	152	.050	1.27	.360	9.14

Slotted Bits

5/16" Hex Power Drive

Part Number	Screw Size	Length		Blade Thickness		Blade Width/Body Diameter	
		In.	mm	In.	mm	In.	mm
635-6X	10F-12R	2 1/4	57	.046	1.17	.360	9.14
635-7X	12F-14R	2 1/4	57	.050	1.27	.395	10.03
635-8X	14F-16R	2 1/4	57	.055	1.40	.457	11.61
635-9X	16F-20R	2 1/4	57	.060	1.52	.503	12.78
635-10X	20F-22R	2 1/4	57	.062	1.57	.545	13.84

If the tool you need does not appear in this catalog, give us a call. The odds are, we may have what you need as a non-catalog item. If not, our experienced staff of tooling experts can design and manufacture "specials" to meet the needs of your specific application. Give us a call at 1-800-845-5629 or visit our website www.apex-tools.com.

10-32 Screw Shank Drive

Part Number	Screw Size	Length		Blade Thickness		Blade Width/Body Diameter	
		In.	mm	In.	mm	In.	mm
103-00X	2F-3R	1 1/2	38	.026	.66	.140	3.56
103-1X	4F-5R	1 1/2	38	.034	.86	.187	4.75
103-2X	5F-6R	1 1/2	38	.036	.91	.225	5.72
103-3X	6F-7R	1 1/2	38	.038	.97	.250	6.35
103-4X	7F-8R	1 1/2	38	.040	1.02	.275	7.24
103-5X	8F-10R	1 1/2	38	.042	1.07	.296	7.52
103-6X	10F-12R	1 1/2	38	.046	1.17	.309	7.85

1/4"-24 Screw Shank Drive

Part Number	Screw Size	Length		Blade Thickness		Blade Width/Body Diameter	
		In.	mm	In.	mm	In.	mm
309-000X	1F-2R	1 1/2	38	.022	.56	.125	3.18
309-00X	2F-3R	1 1/2	38	.026	.66	.140	3.56
309-1X	4F-5R	1 1/2	38	.034	.86	.187	4.75
309-2X	5F-6R	1 1/2	38	.036	.91	.225	5.72
309-3X	6F-7R	1 1/2	38	.038	.97	.250	6.35
309-4X	7F-8R	1 1/2	38	.040	1.02	.285	7.24
309-5X	8F-10R	1 1/2	38	.042	1.07	.296	7.52
309-6X	10F-12R	1 1/2	38	.046	1.17	.315	8.00
309-8X	14F-16R	1 1/2	38	.055	1.40	.361	9.17

Slotted Bits

1/4" Power Drive with Finder Sleeves

Each finder sleeve assembly part number begins with a letter prefix that denotes the particular sleeve used with that assembly. The chart below gives complete dimensional data for each finder sleeve.

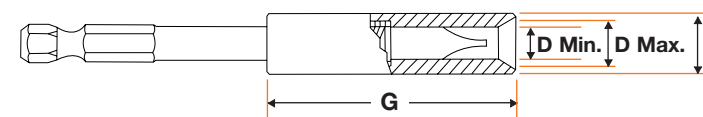

Part No.	Screw Size	D		D		Sleeve Length G		Sleeve Diameter E	
		In.	mm	In.	mm	In.	mm	In.	mm
L	5F-6R	.260	6.60	.233	5.92	1 7/8	47.6	3/8	9.5
M	6F-6R	.309	7.85	.261	6.63	1 7/8	47.6	7/16	11.1
P	8F-6R	.368	9.35	.310	7.87	1 7/8	47.6	1/2	12.7
NP*	8F-10R	.368	9.35	.310	7.87	1 7/8	47.6	7/16	11.1
R	10F-12R	.415	10.54	.369	9.37	2	50.8	9/16	14.3
S	12F-14R	.478	12.14	.416	10.57	2	50.8	5/8	15.9
T	14F-16R	.522	13.26	.479	12.17	2 1/8	54.0	11/16	17.5
U	16F-20R	.621	15.77	.523	13.28	2 1/8	54.0	3/4	19.1
W	20F-22R	.665	16.89	.622	15.80	2 1/16	52.4	13/16	20.3
Y	24F-24R	.715	18.16	.666	16.92	2 1/32	51.6	15/16	23.8

*Sleeve NP is a cup type sleeve.

Slotted Power Bits with Finder Sleeves

1/4" Hex Power Drive

Part No. Complete Assembly	Part No. Bit Only	Screw Size	Bit Length		Blade Thickness		Bit Body Diameter	
			In.	mm	In.	mm	In.	mm
L-320X	320-LX	5F-6R	3 3/4	95	.036	.91	.193	4.90
M-320X	320-MX	6F-8R	3 3/4	95	.038	.97	.241	6.12
P-320X	320-PX	8F-10R	3 3/4	95	.042	1.07	.290	7.37
R-320X	320-RX	10F-12R	3 3/4	95	.046	1.17	.350	8.89
S-320X	320-SX	12F-14R	3 7/8	98	.050	1.27	.395	10.03
T-320X	320-TX	14F-16R	4 1/8	105	.055	1.40	.457	11.61

1/4" Hex Power Drive – Extra Short Series

Part No. Complete Assembly	Part No. Bit Only	Screw Size	Bit Length		Blade Thickness		Bit Body Diameter	
			In.	mm	In.	mm	In.	mm
OOOL-322X	322-000LX	2F-3R	2 3/32	53	.026	.66	.138	3.91
OOL-322X	-	3F-4R	2 3/32	53	.030	.76	.154	3.91
OL-322X	322-0LX	4F-5R	2 5/32	55	.034	.86	.185	4.70
L-322X	-	5F-6R	2 5/32	55	.036	.91	.185	4.70
M-322X	322-MX	6F-8R	2 5/32	55	.040	1.02	.248	6.30
P-322X	-	8F-10R	2 5/32	55	.042	1.07	.283	7.19
R-322X	-	10F-12R	2 5/32	55	.046	1.17	.283	7.19

1/4" Hex Power Drive – Long Series

Part No. Complete Assembly	Part No. Bit Only	Screw Size	Bit Length		Blade Thickness		Bit Body Diameter	
			In.	mm	In.	mm	In.	mm
L-328X	328-LX	5F-6R	6 1/2	165	.036	.91	.193	4.90
M-328X	328-MX	6F-8R	6 1/2	165	.038	.97	.241	6.12
P-328X	328-PX	8F-10R	6 1/2	165	.046	1.07	.290	7.37
R-328X	328-RX	10F-12R	6 1/2	165	.046	1.17	.350	8.89
S-328X	328-SX	12F-14R	6 1/2	165	.050	1.27	.395	10.03

7/16" Hex Power Drive with Finder Sleeves

Part Number	Screw Size	Bit Length		Blade Thickness		Bit Body Diameter	
		In.	mm	In.	mm	In.	mm
R-321X	10F-12R	3 7/8	98	.046	1.17	.350	8.89
S-321X	12F-14R	3 7/8	98	.050	1.27	.395	10.03
T-321X	14F-16R	4 1/8	105	.055	1.40	.457	11.61
U-321X	16F-20R	4 1/8	105	.060	1.52	.503	12.78
W-321X	20F-22R	4 1/8	105	.062	1.57	.545	13.84
Y-321X	24F-24R	4 1/8	105	.065	1.65	.595	15.11

See chart on page 14 for sleeve diameters.

Torx® Bits



1/4" Hex Insert Bits

Part Number	Torxalign® Part Number	Driver Size	A (Ref.)	Overall Length In.	Overall Length mm
440-TX-05X	-	T-5	.055	1	25
440-TX-06X	-	T-6	.065	1	25
440-TX-07X	-	T-7	.077	1	25
440-TX-08X	-	T-8	.090	1	25
440-TX-09X	-	T-9	.097	1	25
440-TX-10X	440-TX-10-W	T-10	.107	1	25
440-TX-15X	440-TX-15-W	T-15	.128	1	25
440-TX-15-125	-	T-15	.128	1 1/4	32
440-TX-20X	440-TX-20-W	T-20	.151	1	25
440-TX-20-125	-	T-20	.151	1 1/4	32
440-TX-20-2	-	T-20	.151	2	51
440-TX-25X	440-TX-25-W	T-25	.173	1	25
440-TX-27X	440-TX-27-W	T-27	.195	1	25
440-TX-30X	440-TX-30-W	T-30	.216	1	25
440-TX-40X	440-TX-40-W	T-40	.260	1	25
440-TX-40I	440-TX-40-W	T-40	.260	1	25
440-TX-45X*	-	T-45	.306	1 1/4	32
440-TX-50X*	-	T-50	.346	1 1/4	32

*Hex will break before rated ultimate torque of the Torx® point is met.



1/4" Hex Insert Bits – Tamper Resistant**

Part Number	Driver Size	A (Ref.)	Overall Length In.	Overall Length mm
440-TX-07-H	T-7-H	.077	1	25
440-TX-08-H	T-8-H	.090	1	25
440-TX-09-H	T-9-H	.097	1	25
440-TX-10-H	T-10-H	.107	1	25
440-TX-15-H	T-15-H	.128	1	25
440-TX-20-H	T-20-H	.151	1	25
440-TX-25-H	T-25-H	.173	1	25
440-TX-27-H	T-27-H	.195	1	25
440-TX-30-H	T-30-H	.216	1	25
440-TX-40-H	T-40-H	.260	1	25

**Tamper resistant Torx® screws feature a post in the center of the recess—this post will only fit into a tamper resistant Torx® bit. Tamper resistant Torx® bits are available on a restricted distribution basis. Contact your local Apex representative for details.



5/16" Hex Insert Bits

Part Number	Driver Size	A (Ref.)	Overall Length In.	Overall Length mm
480-TX-20X	T-20	.151	1 1/4	32
480-TX-25X	T-25	.173	1 1/4	32
480-TX-27X	T-27	.195	1 1/4	32
480-TX-30X	T-30	.216	1 1/4	32
480-TX-40X	T-40	.260	1 1/4	32
480-TX-40-4X	T-40	.260	4	102
480-TX-45X	T-45	.306	1 1/4	32
480-TX-45-6	T-45	.306	6	152
480-TX-50X	T-50	.346	1 1/4	32
480-TX-55X	T-55	.440	1 1/4	32



5/16" Hex Insert Bits – Tamper Resistant**

Part Number	Driver Size	A (Ref.)	Overall Length In.	Overall Length mm
480-TX-40-H	T-40-H	.260	1 1/4	32
480-TX-45-H	T-45-H	.306	1 1/4	32
480-TX-50-H	T-50-H	.346	1 1/4	32
480-TX-55-H	T-55-H	.440	1 1/4	32

**Tamper resistant Torx® bits are available on a restricted distribution basis. Contact your local Apex representative for details.



5/8" Hex Insert Bits

Part Number	Hex Flat Type*	Driver Size	A (Ref.)	Overall Length In.	Overall Length mm
SZ-TX-55-A	DP	T-55	.440	1 9/16	40
SZ-TX-60-A	DP	T-60	.520	1 9/16	40
SZ-TX-70-A	DP	T-70	.610	1 9/16	40
SZ-TX-70-A-3	TH	T-70	.610	3	76
SZ-TX-80-A	TH	T-80	.689	1 9/16	40

*DP-Drill Point; TH-Thru Hole. 5/8" insert bits are used with SC and RP adapters found on pages 51.



7/8" Hex Insert Bits

Part Number	Hex Flat Type*	Driver Size	A (Ref.)	Overall Length In.	Overall Length mm
SZ-TX-90-A	TH	T-90	.782	2	51
SZ-TX-100-A	TH	T-100	.870	2	51

*TH-Thru Hole. 7/8" insert bits are used with RP adapters found on pages 51.

Torx® Bits



1/4" Hex Power Drive

Part Number	Driver Size	A (Ref.)	Body Diameter In.	Body Diameter mm	Overall Length In.	Overall Length mm
49-TX-05	T-5	.055	.119	3.0	1 15/16	49
49-A-TX-05	T-5	.055	.119	3.0	2 3/4	70
49-B-TX-05	T-5	.055	.119	3.0	3 1/2	89
49-TX-06	T-6	.065	.119	3.0	1 15/16	49
49-A-TX-06	T-6	.065	.119	3.0	2 3/4	70
49-TX-07	T-7	.077	.119	3.0	1 15/16	49
49-A-TX-07	T-7	.077	.119	3.0	2 3/4	70
49-B-TX-07	T-7	.077	.119	3.0	3 1/2	89
49-C-TX-07	T-7	.077	.119	3.0	6	152
49-TX-08	T-8	.090	.119	3.0	1 15/16	49
49-A-TX-08	T-8	.090	.119	3.0	2 3/4	70
49-B-TX-08	T-8	.090	.119	3.0	3 1/2	89
49-C-TX-08	T-8	.090	.119	3.0	6	152
49-TX-09	T-9	.097	.119	3.0	1 15/16	49
49-A-TX-09	T-9	.097	.119	3.0	2 3/4	70
49-B-TX-09	T-9	.097	.119	3.0	3 1/2	89
49-C-TX-09	T-9	.097	.119	3.0	6	152
49-TX-10	T-10	.107	.150	3.8	1 15/16	49
49-A-TX-10	T-10	.107	.150	3.8	2 3/4	70
SD-4693	T-10	.107	.150	3.8	3	75
49-B-TX-10	T-10	.107	.150	3.8	3 1/2	89
49-C-TX-10	T-10	.107	.150	3.8	6	152
49-TX-15	T-15	.128	.150	3.8	1 15/16	49
49-A-TX-15	T-15	.128	.150	3.8	2 3/4	70
49-B-TX-15	T-15	.128	.150	3.8	3 1/2	89
49-C-TX-15	T-15	.128	.150	3.8	6	152
49-TX-20	T-20	.151	.171	4.3	1 15/16	49
49-A-TX-20	T-20	.151	.171	4.3	2 3/4	70
49-B-TX-20	T-20	.151	.171	4.3	3 1/2	89
49-TX-20-5	T-20	.151	.171	4.3	5	127
49-C-TX-20	T-20	.151	.171	4.3	6	152
49-TX-25	T-25	.173	.193	4.9	1 15/16	49
49-A-TX-25	T-25	.173	.193	4.9	2 3/4	70
49-B-TX-25	T-25	.173	.193	4.9	3 1/2	89
49-C-TX-25	T-25	.173	.193	4.9	6	152
49-TX-27	T-27	.195	.215	5.5	1 15/16	49
49-A-TX-27	T-27	.195	.215	5.5	2 3/4	70
49-B-TX-27	T-27	.195	.215	5.5	3 1/2	89
49-C-TX-27	T-27	.195	.215	5.5	6	152
49-TX-30	T-30	.216	.236	6.0	1 15/16	49
49-A-TX-30	T-30	.216	.236	6.0	2 3/4	70
49-B-TX-30	T-30	.216	.236	6.0	3 1/2	89
49-C-TX-30	T-30	.216	.236	6.0	6	152
49-TX-40	T-40	.260	.309	7.8	1 15/16	49
49-A-TX-40	T-40	.260	.309	7.8	2 3/4	70
49-B-TX-40	T-40	.260	.309	7.8	3 1/2	89
49-C-TX-40	T-40	.260	.309	7.8	6	152



1/4" Hex Power Drive – Torxalign®

Part Number	Driver Size	A (Ref.)	Body Diameter In.	Body Diameter mm	Overall Length In.	Overall Length mm
49-TX-08-W	T-8	.090	.119	3.0	1 15/16	49
49-TX-10-W	T-10	.107	.150	3.8	1 15/16	49
49-TX-15-W	T-15	.128	.150	3.8	1 15/16	49
49-A-TX-15-W	T-15	.128	.150	3.8	2 3/4	70
49-B-TX-15-W	T-15	.128	.150	3.8	3 1/2	89
49-TX-20-W	T-20	.151	.171	4.3	1 15/16	49
49-B-TX-20-W	T-20	.151	.171	4.3	3 1/2	89
49-TX-25-W	T-25	.173	.193	4.9	1 15/16	49
49-TX-27-W	T-27	.195	.215	5.5	1 15/16	49
49-TX-30-W	T-30	.216	.236	6.0	1 15/16	49
49-B-TX-30-W	T-30	.216	.236	6.0	3 1/2	89



1/4" Hex Power Drive – Tamper Resistant**

Part Number	Driver Size	A (Ref.)	Body Diameter In.	Body Diameter mm	Overall Length In.	Overall Length mm
49-TX-10-H	T-10-H	.107	.150	3.8	1 15/16	49
49-A-TX-10-H	T-10-H	.107	.150	3.8	2 3/4	70
49-TX-15-H	T-15-H	.128	.150	3.8	1 15/16	49
49-A-TX-15-H	T-15-H	.128	.150	3.8	2 3/4	70
49-B-TX-15-H	T-15-H	.128	.150	3.8	3 1/2	89
49-A-TX-20-H	T-20-H	.151	.171	4.3	2 3/4	70
49-B-TX-20-H	T-20-H	.151	.171	4.3	3 1/2	89
49-C-TX-20-H	T-20-H	.151	.171	4.3	6	152

**Tamper resistant Torx® bits are available on a restricted distribution basis. Contact your local Apex representative for details.



1/4" Hex Power Drive with Finder Sleeves

Part Number	Driver Size	Sleeve Number*	A (Ref.)	Sleeve Diameter In.	Sleeve Diameter mm	Overall Length In.	Overall Length mm
M-32-TX-15	T-15	M	.128	.437	12.1	3 1/2	89
M-32-TX-20	T-20	M	.151	.437	12.1	3 1/2	89
NP-32-TX-25	T-25	NP	.173	.437	12.1	3 3/4	95
R-32-TX-27	T-27	R	.195	.563	14.3	3 5/8	92
S-32-TX-30	T-30	S	.216	.625	15.9	3 7/8	98

*See page 14 for Sleeve Selection



7/16" Hex Power Drive

Part Number	Driver Size	A (Ref.)	Body Diameter In.	Body Diameter mm	Overall Length In.	Overall Length mm
48-TX-40	T-40	.260	.277	7.0	3 1/2	89
48-TX-45	T-45	.306	.323	8.2	3 1/2	89
48-TX-50	T-50	.346	.363	9.2	3 1/2	89
48-TX-55	T-55	.440	.503	12.8	3 3/4	95

Torx® Bits



10-32 Screw Shank Drive

Part Number	Driver Size	Point Size	Body Diameter In.	mm	Overall Length In.	mm
50-TX-08	T-8	.090	.125	3.2	1 1/2	38
50-TX-10	T-10	.107	.150	3.8	1 1/2	38
50-TX-15	T-15	.128	.150	3.8	1 1/2	38
50-TX-20	T-20	.151	.171	4.3	1 1/2	38



12-24 Screw Shank Drive

Part Number	Driver Size	Point Size	Body Diameter In.	mm	Overall Length In.	mm
55-TX-10	T-10	.107	.150	3.8	1 3/16	30
55-TX-15	T-15	.128	.150	3.8	1 3/16	30
SD-4048	T-15	.128	.309	7.8	1 3/16	30
55-TX-20	T-20	.151	.171	4.3	1 3/16	30
55-TX-25	T-25	.173	.193	4.9	1 3/16	30
55-TX-30	T-30	.216	.309	7.8	1 3/16	30



Female Square Service Drive

Part Number	Driver Size	Point Size	Square Drive	Body Diameter In.	mm	Overall Length In.	mm
834-TX-25	T-25	.173	3/8	.240	6.1	2 13/16	71
834-TX30-1.62	T-30	.216	3/8	.234	5.9	1 5/8	41
834-TX40-2.95	T-40	.260	3/8	.277	7.0	2 61/64	75
834-TX50-1.62	T-50	.346	3/8	.373	9.4	1 1/4	41
834-TX-45-5	T-45	.306	3/8	.323	8.2	5	125
834-TX-50	T-50	.346	3/8	.363	9.2	2 5/8	66
854-TX-50	T-50	.346	1/2	.323	8.2	2 7/8	73
854-TX-55-150M	T-55	.440	1/2	.363	9.2	5 7/8	150

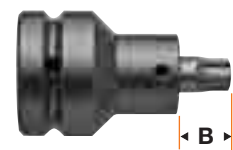

1" Square Drive Adapters with Torx® Insert Bit

Part Number	Driver Size	Point Size	Overall Length In.	mm	Bit Length (B) In.	mm
SZ-8L-TX-70	T-70	.610	3 19/32	91	.90	23
SZ-TX-100	T-100	.870	3 19/32	91	1.13	29

Torx Plus® Bits



1/4" Hex Insert Bits

Part Number	Driver Size	Point Size	Overall Length In.	mm
440-10IPX	10IP	.107	1	25
440-15IPX	15IP	.128	1	25
440-20IPX	20IP	.151	1	25
440-25IPX	25IP	.173	1	25
440-27IPX	27IP	.195	1	25
440-30IPX	30IP	.216	1	25
440-40IPX	40IP	.260	1	25



1/4" Hex Insert Bits – Tamper Resistant**

Part Number	Driver Size	Point Size	Overall Length In.	mm
440-10IPRX	10IPR	.107	1	25
440-15IPRX	15IPR	.128	1	25
440-20IPRX	20IPR	.151	1	25
440-25IPRX	25IPR	.173	1	25
440-27IPRX	27IPR	.195	1	25
440-30IPRX	30IPR	.216	1	25
440-40IPRX	40IPR	.260	1	25

**Tamper resistant Torx Plus® bits are available on a restricted distribution basis. Contact your local Apex representative for details.



5/16" Hex Insert Bits

Part Number	Driver Size	Point Size	Overall Length In.	mm
480-30IPX	30IPR	.216	1 1/4	32
480-40IPX	40IPR	.260	1 1/4	32
480-45IPX	45IPR	.306	1 1/4	32
480-50IPX	50IPR	.346	1 1/4	32
480-55IPX	55IPR	.440	1 1/4	32

Ask your local Apex Representative about MorTorq® Super Bits



Torx Plus® Bits



1/4" Hex Power Drive

Part Number	Driver Size	Point Size	Overall Length In.	mm
49-10IPX	10IP	.107	1 15/16	49
49-A-10IPX	10IP	.107	2 3/4	70
49-B-10IPX	10IP	.107	3 1/2	89
49-15IPX	15IP	.128	1 15/16	49
49-A-15IPX	15IP	.128	2 3/4	70
49-B-15IPX	15IP	.128	3 1/2	89
49-20IPX	20IP	.151	1 15/16	49
49-A-20IPX	20IP	.151	2 3/4	70
49-B-20IPX	20IP	.151	3 1/2	89
49-25IPX	25IP	.173	1 15/16	49
49-A-25IPX	25IP	.173	2 3/4	70
49-B-25IPX	25IP	.173	3 1/2	89
49-27IPX	27IP	.195	1 15/16	49
49-A-27IPX	27IP	.195	2 3/4	70
49-B-27IPX	27IP	.195	3 1/2	89
49-30IPX	30IP	.216	1 15/16	49
49-A-30IPX	30IP	.216	2 3/4	70
49-B-30IPX	30IP	.216	3 1/2	89
49-40IPX	40IP	.260	1 15/16	49



1/4" Hex Power Drive – Tamper Resistant

Part Number	Driver Size	Point Size	Overall Length In.	mm
49-10IPRX	10IPR	.107	1 15/16	49
49-15IPRX	15IPR	.128	1 15/16	49
49-20IPRX	20IPR	.151	1 15/16	49
49-25IPRX	25IPR	.173	1 15/16	49
49-27IPRX	27IPR	.195	1 15/16	49
49-30IPRX	30IPR	.216	1 15/16	49
49-40IPRX	40IPR	.260	1 15/16	49

**Tamper resistant Torx Plus® bits are available on a restricted distribution basis. Contact your local Apex representative for details.

Pozidriv® Bits



1/4" Hex Insert Bits

Part Number	Point Size	Overall Length In.	mm
440-1-PZDX	1	1	25
440-2-PZDX	2	1	25
440-215-PZDX	2	1 1/2	38
440-22-PZDX	2	2	51
440-3-PZDX	3	1	25
440-4-PZDX	4	1 1/4	32

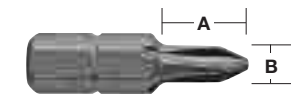

1/4" Hex Insert Bits – Limited Clearance

Part Number	Point Size	Overall Length In.	mm	Turned Length (A) In.	mm	Turned OD (B) In.	mm
446-1-PZDX	1	1	25.4	7/16	11	0.18	4.6
446-2-PZDX	2	1	25.4	7/16	11	0.18	4.6



5/16" Hex Insert Bits

Part Number	Point Size	Overall Length In.	mm
480-1-PZDX	1	1 1/4	32
480-2-PZDX	2	1 1/4	32
480-3-PZDX	3	1 1/4	32



1/4" Hex Power Drive

Part Number	Point Size	Overall Length In.	mm	Body Diameter In.	mm	Turned Length In.	mm
491-PZDX	1	1 15/16	49	3/16	4.8	1 1/4	32
491-A-PZDX	1	2 3/4	70	3/16	4.8	2	51
491-B-PZDX	1	3 1/2	89	3/16	4.8	2 3/4	70
491-C-PZDX	1	6	152	3/16	4.8	2	51
492-PZDX	2	1 15/16	49	1/4	6.4	1 1/4	32
492-A-PZDX	2	2 3/4	70	1/4	6.4	2	51
492-B-PZDX	2	3 1/2	89	1/4	6.4	2 3/4	70
492-C-PZDX	2	6	152	1/4	6.4	2	51
493-PZDX	3	1 15/16	49	5/16	7.9	1	25
493-A-PZDX	3	2 3/4	70	5/16	7.9	1 3/4	44
493-B-PZDX	3	3 1/2	89	5/16	7.9	2 1/4	57
493-C-PZDX	3	6	152	5/16	7.9	5	127



1/4" -24 Screw Shank Drive

Part Number	Point Size	Overall Length In.	mm	Body Diameter In.	mm
401-PZDX	1	1 1/2	38	3/16	4.8
402-PZDX	2	1 1/2	38	1/4	6.4
403-PZDX	3	1 1/2	38	5/16	7.9



8-32 Screw Shank Drive

Part Number	Point Size	Overall Length In.	mm	Body Diameter In.	mm
591-PZDX	1	1 3/16	30	7/32	5.6
592-PZDX	2	1 3/16	30	7/32	5.6



10-32 Screw Shank Drive

Part Number	Point Size	Overall Length In.	mm	Body Diameter In.	mm
502-PZDX	2	1 1/2	38	1/4	6.4
SD-1342-2-PZD	2	1 3/4	45	1/4	6.4

Sel-O-Fit Bits



1/4" Hex Insert Bits

Part Number	Point Size	Overall Length	
		In.	mm
440-1-SFX	1	1	25
440-2-SFX	2	1	25
440-215-SFX	2	1 1/2	38
440-22-SFX	2	2	51
440-225-SFX	2	2 1/2	64
440-3-SFX	3	1	25



1/4" Hex Insert Bits – Limited Clearance

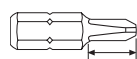

Part Number	Point Size	Overall Length In.	Overall Length mm	Turned Length (A) In.	Turned Length (A) mm	Turned OD (B) In.	Turned OD (B) mm
446-2-SFX	2	1	25	7/16	11	0.18	4.6



5/16" Hex Insert Bits

Part Number	Point Size	Overall Length	
		In.	mm
480-2-SFX	2	1 1/4	32



1/4" Hex Power Drive

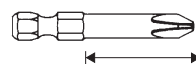

Part Number	Point Size	Overall Length		Body Diameter		Turned Length	
		In.	mm	In.	mm	In.	mm
491-SFX	1	1 15/16	49	3/16	5	1 1/4	32
491-A-SFX	1	2 3/4	70	3/16	5	2	51
491-B-SFX	1	3 1/2	89	3/16	5	2 3/4	70
491-C-SFX	1	6	152	3/16	5	2	51
492-SFX	2	1 15/16	49	1/4	6	1 1/4	32
492-A-SFX	2	2 3/4	70	1/4	6	2	51
492-B-SFX	2	3 1/2	89	1/4	6	2 3/4	70
492-C-SFX	2	6	152	1/4	6	2	51

Sel-O-Fit® bits are designed to provide a more efficient means of driving Pozidriv® screws.

The Sel-O-Fit bit places torque on the strongest and most mechanically advantageous portion of the driver tip. This allows more torque to be applied while minimizing the possibility of breakage and camout.

Sel-O-Fit® is a registered trademark of Cooper Industries.

Quadrex® Bits

1/4" Hex Insert Bits

Part Number	Point Size	Overall Length	
		In.	mm
950-QD-2	2	1	25

1/4" Hex Power Drive

Part Number	Point Size	Overall Length		Body Diameter		Turned Length	
		In.	mm	In.	mm	In.	mm
95-QD-2	2	1 15/16	49	1/4	6	1 1/4	32
95-A-QD-2	2	2 3/4	70	1/4	6	2	51
95-B-QD-2	2	3 1/2	89	1/4	6	2 3/4	70
95-QD-3	3	1 15/16	49	5/16	7.9	1 1/4	32

If the tool you need does not appear in this catalog, give us a call. The odds are, we may have what you need as a non-catalog item. If not, our experienced staff of tooling experts can design and manufacture "specials" to meet the needs of your specific application. Give us a call at 1-800-845-5629 or visit our website www.apex-tools.com.

Frearson Bits



1/4" Hex Insert Bits

Part Number	Point Size	Overall Length	
		In.	mm
440-FX	All	1	25
446-FX	All	1	25

For limited clearance



5/16" Hex Insert Bit

Part Number	Point Size	Overall Length	
		In.	mm
480-FX	All	1 3/8	35



1/4" Hex Power Drive

Part Number	Screw Size	Overall Length		Body Diameter		Turned Length	
		In.	mm	In.	mm	In.	mm
491-FX	All	1 15/16	49	3/16	5	1 1/4	32
491-AFX	All	2 3/4	70	3/16	5	2	51
491-BFX	All	3 1/2	89	3/16	5	2 3/4	70
491-CFX	All	6	152	3/16	5	2	51
492-FX	All	1 15/16	49	1/4	6	1 1/4	32
492-AFX	All	2 3/4	70	1/4	6	2	51
492-BFX	All	3 1/2	89	1/4	6	2 3/4	70
492-CFX	All	6	152	1/4	6	2	51
493-FX	All	1 15/16	49	5/16	8	1	25
493-BFX	All	3 1/2	89	5/16	8	2 1/2	64

The Frearson recess is designed so that any size bit will fit any size recess. Choose bits on the basis of body diameter – the larger the screw, the larger the body diameter.



12-24 Screw Shank Drive

Part Number	Screw Size	Overall Length		Body Diameter	
		In.	mm	In.	mm
552-FX	All	1 3/16	30	.30	8



1/4" Female Square Drive

Part Number	Screw Size	Overall Length		Body Diameter	
		In.	mm	In.	mm
822-F	All	2	51	1/4	6



3/8" Female Square Drive

Part Number	Screw Size	Overall Length		Body Diameter	
		In.	mm	In.	mm
832-F	All	2 5/8	67	1/4	6
833-F	All	2 5/8	67	5/16	8
834-F	All	2 5/8	67	3/8	10

ACR® is a trademark of the Phillips Screw Co.

B.N.A.E. Bits



1/4" Hex Insert Bits

Part Number	Point Size	Overall Length	
		In.	mm
BNAE-3mm	3mm	1 1/8	29
BNAE-4mm	4mm	1 1/8	29
BNAE-5mm	5mm	1 1/8	29
BNAE-6mm	6mm	1 1/8	29
BNAE-8mm	8mm	1 1/8	29



1/4" Hex Insert Bits – ACR®

Part Number	Point Size	Overall Length	
		In.	mm
BNAE-4mm-ACR	4mm	1 1/8	29
BNAE-5mm-ACR	5mm	1 1/8	29
BNAE-6mm-ACR	6mm	1 1/8	29



ACR® ribs for both removal and driving

Socket Head Sizing Chart

SAE									
Nominal Hex Size, Inches	Socket Head Cap Screws 1960 Series	Socket Head Cap Screws 1936 Series	Flat Head Cap Screws	Button Head Cap Screws	Set Screws	Shoulder Screws	Pressure Plugs	Allenuts	Low Head Cap Screws
.050	0	0, 1	1, 2	3, 4	—	—	—	4	.050
1/16	1	2	3, 4	3, 4	5, 6	—	—	—	5, 6
5/64	2, 3	3, 4	5, 6	5, 6	8	—	—	—	8
3/32	4, 5	5, 6	8	8	10	—	—	—	10
7/64	6	—	—	—	—	—	—	—	—
1/8	—	8	10	10	1/4	1/4	—	4, 5	1/4
9/64	8	10	—	—	—	—	—	—	—
5/32	10	1/4	1/4	1/4	5/16	5/16	1/16	6	5/16
3/16	1/4	—	5/16	5/16	3/8	3/8	1/8	8, 10	3/8
7/32	—	5/16	3/8	3/8	7/16	—	—	—	7/16
1/4	5/16	—	7/16	—	1/2	1/2	1/4	1/4	1/2
5/16	3/8	3/8, 7/16	1/2	—	5/8	5/8	3/8	5/16	5/8
3/8	7/16, 1/2	1/2	5/8	—	3/4	3/4	1/2	3/8	—
7/16	—	—	—	—	—	—	—	7/16	—
1/2	5/8	5/8	3/4	—	7/8	1	—	1/2	—
9/16	—	3/4, 7/8	7/8	—	1, 1 1/8	—	3/4	—	—
5/8	3/4	1	1	—	1 1/4, 1 3/8	1 1/4	1	5/8	—
3/4	7/8, 1	1 1/8, 1 1/4, 1 3/8	1 1/8	—	1 1/2	—	1 1/4	3/4	—
7/8	1 1/8, 1 1/4	—	1 1/4, 1 3/8	—	—	1 1/2	—	7/8	—
1	1 3/8, 1 1/2	1 1/2	1 1/2	—	1 3/4, 2	1 3/4	1 1/2, 2	1	—
1 1/4	1 3/4	—	—	—	—	2	—	1 1/4	—
1 1/2	2	—	—	—	—	—	—	1 1/2	—
1 3/4	2 1/4, 2 1/2	—	—	—	—	—	—	—	1 3/4
2	2 3/4	—	—	—	—	—	—	—	—

Metric							
Nominal hex Size, MM	Socket Head Cap Screws	Flat Head Cap Screws	Button Head Cap Screws	Set Screws	Shoulder Screws	Allenuts	Low Head Cap Screws
1.5	M1.6, M1.7, M2	—	—	M3	—	—	—
2	M2.3, M2.5, M2.6	M3	M3	M4	—	—	—
2.5	M3	M4	M4	M5	—	—	—
3	M4	M5	M5	M6	6mm	M3	M4
4	M5	M6	M6	M8	8mm	M4	M5
5	M6	M8	M8	M10	10mm	M5	M6
6	M8	M10	M10	M12, M14	12mm	M6	M8
8	M10	M12	M12	M16	16mm	M8	M10
10	M12	M14, M16	—	M20	20mm	M10	M12
12	M14	M20	—	M24	—	M12	M14
14	M16	—	—	—	—	—	M16
17	M20	—	—	—	—	M16	M20, M22
19	M24	—	—	—	—	—	M24

Socket Head Bits

1/4" Hex Insert Bits

Part Number	Hex Size	Overall Length	
		In.	mm
185-000X	.050	1	25
185-00X	1/16	1	25
185-0X	5/64	1	25
185-1X	3/32	1	25
185-9X	7/64	1	25
185-2X	1/8	1	25
185-10X	9/64	1	25
185-3X	5/32	1 5/16	33
185-4X	3/16	1 5/16	33
185-4-4X	3/16	4	102
185-5X	7/32	1 5/16	33
185-6X	1/4	1 5/16	33
185-7X	5/16	1 1/4	32
185-8X	3/8	1 1/4	32

1/4" Hex Insert Bits – Metric

Part Number	Hex Size	Overall Length	
		In.	mm
185-1.5mm	1.5mm	1	25
185-2mm	2mm	1	25
185-2.5mm	2.5mm	1	25
185-3mm	3mm	1	25
185-4mm	4mm	1 5/16	33
185-5mm	5mm	1 5/16	33
185-6mm	6mm	1 5/16	33
185-7mm	7mm	1 1/4	32
185-8mm	8mm	1 1/4	32
185-9mm	9mm	1 1/4	32
185-10mm	10mm	1 1/4	32

5/16" Hex Insert Bits

Part Number	Hex Size	Overall Length	
		In.	mm
315-3X	5/32	1 5/16	33
315-4X	3/16	1 5/16	33
315-5X	7/32	1 5/16	33
315-6X	1/4	1 5/16	33
315-7X	5/16	1 5/16	33
315-8X	3/8	1 5/16	33

5/16" Hex Insert Bits – Metric

Part Number	Hex Size	Overall Length	
		In.	mm
315-2.5mm	2.5mm	1	25
315-4mm	4mm	1 5/16	33
315-5mm	5mm	1 5/16	33
315-6mm	6mm	1 5/16	33
315-7mm	7mm	1 5/16	33
315-8mm	8mm	1 5/16	33
315-10mm	10mm	1 3/8	35
315-12mm	12mm	1 1/4	32
315-14mm	14mm	1 1/4	32

1/4" Hex Power Drive

Part Number	Hex Size	Overall Length	
		In.	mm
AM-01-A	0.050	1 15/16	49
AM-02	1/16	1 15/16	49
AM-02-A	5/64	1 15/16	49
AM-03	3/32	1 15/16	49
AM-03-3	3/32	3	76
AM-03-6	3/32	6	152
AM-03-A	7/64	1 15/16	49
AM-04	1/8	1 15/16	49
AM-04-3	1/8	3	76
AM-04-35	1/8	3 1/2	89
AM-04-4	1/8	4	102
AM-04-5	1/8	5	127
AM-04-6	1/8	6	152
AM-04-A	9/64	1 15/16	49
AM-04-A-4	9/64	4	102
AM-05	5/32	1 15/16	49
AM-05-3	5/32	3	76
AM-05-35	5/32	3 1/2	89
AM-05-4	5/32	4	102
AM-05-5	5/32	5	127
AM-05-6	5/32	6	152
AM-05-8	5/32	8	203
AM-06	3/16	1 15/16	49
AM-06-3	3/16	3	76
AM-06-4	3/16	4	102
AM-06-6	3/16	6	152
AM-07	7/32	1 15/16	49
AM-08	1/4	1 15/16	49
AM-10	5/16	1 15/16	49

1/4" Hex Power Drive – Metric

Part Number	Hex Size	Overall Length	
		In.	mm
AM-1.5mm	1.5mm	1 15/16	49
AM-2mm	2mm	1 15/16	49
AM-2.5mm	2.5mm	1 15/16	49
AM-3mm	3mm	1 15/16	49
AM-3mm-3	3mm	3	76
AM-3mm-4	3mm	4	102
AM-4mm	4mm	1 15/16	49
AM-5mm	5mm	1 15/16	49
AM-5mm-4	5mm	4	102
AM-6mm	6mm	1 15/16	49
AM-6mm-4	6mm	4	102
AM-7mm	7mm	1 15/16	49
AM-8mm	8mm	1 15/16	49
AM-10mm	10mm	1 15/16	49

5/16" Hex Power Drive

Part Number	Hex Size	Overall Length	
		In.	mm
AS-06	3/16	3	76
AS-10	5/16	3	76
AS-12	3/8	3	76

Socket Head Bits



7/16" Hex Power Drive



Part Number	Hex Size	Overall Length	
		In.	mm
AN-04	1/8	3 1/2	89
AN-04-A	9/64	3 1/2	89
AN-05	5/32	3 1/2	89
AN-05-6	5/32	6	152
AN-06	3/16	3 1/2	89
AN-06-6	3/16	6	152
AN-07	7/32	3 1/2	89
AN-07-8	7/32	8	203
AN-08	1/4	3 1/2	89
AN-08-8	1/4	8	203
AN-09	9/32	3 1/2	89
AN-10	5/16	3 1/2	89
AN-10-6	5/16	6	152
AN-12	3/8	3 1/2	89
AN-12-6	3/8	6	152
AN-16	1/2	3 1/2	89
AN-16-6	1/2	6	152

7/16" Hex Power Drive, Metric



Part Number	Size	Hex	Overall Length	
			In.	mm
AN-3mm	3mm		3 1/2	89
AN-4mm	4mm		3 1/2	89
AN-5mm	5mm		3 1/2	89
AN-6mm	6mm		3 1/2	89
AN-8mm	8mm		3 1/2	89
AN-10mm	10mm		3 1/2	89
AN-12mm	12mm		3 1/2	89
AN-14mm	14mm		3 1/2	89
AN-14mm-6	14mm		6	152

5/8" Hex Power Drive



Part Number	Hex Size	Overall Length	
		In.	mm
AP-08	1/4	4	102
AP-10	5/16	4	102
AP-12	3/8	4	102
AP-16	1/2	4	102
AP-18	9/16	4	102
AP-20	5/8	4	102
AP-24	3/4	4	102

Socket Head Bits with Square Drive Adapters, SAE



3/8" Square Drive

Complete	Part Number		Hex Size	Overall Length		Length of Insert	
	Adapter Only	Insert Only		In.	mm	In.	mm
SZ-9	SC-314	SZ-9-A	3/32	2 1/4	57	1 3/8	35
SZ-7	SC-314	SZ-7-A	7/64	2 1/4	57	1 3/8	35
SZ-10	SC-314	SZ-10-A	1/8	2 1/4	57	1 3/8	35
SZ-11	SC-314	SZ-11-A	5/32	2 1/4	57	1 3/8	35
SZ-12	SC-314	SZ-12-A	3/16	2 1/4	57	1 3/8	35
SZ-13	SC-314	SZ-13-A	7/32	2 1/4	57	1 3/8	35
SZ-14	SC-314	SZ-14-A	1/4	2 1/4	57	1 3/8	35
SZ-15	SC-314	SZ-15-A	5/16	2 1/4	57	1 3/8	35
SZ-16	SC-314	SZ-16-A	3/8	2 1/4	57	1 3/8	35
SZ-17	SC-314	SZ-17-A	1/2	2 1/4	57	1 3/8	35
SZ-18	SC-314	SZ-18-A	9/16	2 1/4	57	1 3/8	35
SZ-19	SC-314	SZ-19-A	5/8	2 1/4	57	1 3/8	35

1/2" Square Drive



Complete	Part Number		Hex Size	Overall Length		Length of Insert	
	Adapter Only	Insert Only		In.	mm	In.	mm
SZ-41	SC-514	SZ-11-A	5/32	2 1/2	64	1 3/8	35
SZ-20	SC-514	SZ-12-A	3/16	2 1/2	64	1 3/8	35
SZ-21	SC-514	SZ-13-A	7/32	2 1/2	64	1 3/8	35
SZ-22	SC-514	SZ-14-A	1/4	2 1/2	64	1 3/8	35
SZ-23	SC-514	SZ-15-A	5/16	2 1/2	64	1 3/8	35
SZ-24	SC-514	SZ-16-A	3/8	2 1/2	64	1 3/8	35
SZ-25	SC-514	SZ-17-A	1/2	2 1/2	64	1 3/8	35
SZ-42	SC-520	SZ-31-A	1/2	2 1/2	64	1 9/16	40
SZ-43	SC-514	SZ-18-A	9/16	2 1/2	64	1 3/8	35
SZ-44	SC-520	SZ-32-A	9/16	2 1/2	64	1 9/16	40
SZ-26	SC-514	SZ-19-A	5/8	2 1/2	64	1 3/8	35
SZ-27	RP-520	SZ-33-A	5/8	2 1/2	64	1 9/16	40

Adapters with an "SC" prefix feature a set screw for locking in the bit.
An "RP" prefix indicates adapters with a thru hole for a spring pin.

7/16" Hex Insert Bit Only



Part Number	Hex Size	Overall Length	
		In.	mm
SZ-11-A-3	5/32	3	76
SZ-12-A-2	3/16	2	51
SZ-12-A-3	3/16	3	76
SZ-12-A-6	3/16	6	152
SZ-13-A-3	7/32	3	76
SZ-14-A-3	1/4	3	76
SZ-14-A-4	1/4	4	102
SZ-15-A-2	5/16	2	51
SZ-15-A-3	5/16	3	76
SZ-15-A-4	5/16	4	102
SZ-16-A-3	3/8	3	76
SZ-16-A-4	3/8	4	102

Use 7/16" Hex Insert Bits with 7/16" Female Hex Square drive adapters, page 26. These bits feature a thru hole on the hex flat for use with a spring pin.

Socket Head Bits with Square Drive Adapters, SAE



3/4" Square Drive

Complete	Part Number		Hex Size	Overall Length		Length of Insert		Bit Length (A)	
	Adapter Only	Insert Only		In.	mm	In.	mm	In.	mm
SZ-30	SC-720	SZ-30-A	3/8	2 5/8	67	1 9/16	40	29/32	23
SZ-31	SC-720	SZ-31-A	1/2	2 5/8	67	1 9/16	40	29/32	23
SZ-32	SC-720	SZ-32-A	9/16	2 5/8	67	1 9/16	40	29/32	23
SZ-33	RP-720	SZ-33-A	5/8	2 5/8	67	1 9/16	40	29/32	23
SZ-34	RP-720	SZ-34-A	3/4	2 5/8	67	1 9/16	40	29/32	23
SZ-37	RP-728	SZ-37-A	3/4	3 1/8	79	2	51	1 1/8	29
SZ-35	SC-720	SZ-35-A	7/8	2 5/8	67	1 9/16	40	29/32	23
SZ-38	RP-728	SZ-38-A	7/8	3 1/8	79	2	51	1 1/8	29
SZ-36	RP-720	SZ-36-A	1	2 5/8	67	1 9/16	40	29/32	23

1" Square Drive



Complete	Part Number		Hex Size	Overall Length		Length of Insert		Bit Length (A)	
	Adapter Only	Insert Only		In.	mm	In.	mm	In.	mm
SZ-80	RP-820	SZ-31-A	1/2	3 1/16	78	1 9/16	40	29/32	23
SZ-85	RP-828	SZ-85-A	5/8	3 1/4	83	2	51	1 1/8	29
SZ-86	RP-820	SZ-34-A	3/4	3 1/32	77	1 9/16	40	29/32	23
SZ-87	RP-828	SZ-37-A	3/4	3 1/4	83	2	51	1 1/8	29
SZ-88	SC-820	SZ-35-A	7/8	3 1/16	78	1 9/16	40	29/32	23
SZ-89	RP-828	SZ-38-A	7/8	3 1/4	83	2	51	1 1/8	29
SZ-91	RP-828	SZ-39-A	1	3 1/4	83	2	51	1 1/8	29
SZ-101	RP-848	SZ-101-A	1 1/4	3 1/2	89	2 5/8	67	1 3/8	35

An "RP" prefix indicates adapters with a roll pin that is inserted through the bit.

Socket Head Bit & Adapter Sets, SAE



APH38 8 piece, 3/8" square drive:
1/8, 9/64, 5/32, 3/16, 7/32, 1/4, 5/16, 3/8

APH56 6 piece, 1/2" square drive:
1/4, 5/16, 3/8, 1/2, 9/16, 5/8

Socket Head Bit & Adapter Sets, Metric



APH35M 5 piece, 3/8" square drive:
4mm, 5mm, 6mm, 8mm, 10mm

APH56M 6 piece, 1/2" square drive:
6mm, 8mm, 10mm, 12mm, 14mm, 17mm

Socket Head Adapters & Inserts, Metric



3/8" Square Drive

Complete	Part Number		Hex Size	Overall Length		Length of Insert		Bit Length (A)	
	Adapter Only	Insert Only		In.	mm	In.	mm	In.	mm
SZ-3-7-4mm	SC-314	SZ-7-4mm	4mm	2 1/4	57	1 3/8	35	7/8	22
SZ-3-7-5mm	SC-314	SZ-7-5mm	5mm	2 1/4	57	1 3/8	35	7/8	22
SZ-3-7-6mm	SC-314	SZ-7-6mm	6mm	2 1/4	57	1 3/8	35	7/8	22
SZ-3-7-8mm	SC-314	SZ-7-8mm	8mm	2 1/4	57	1 3/8	35	7/8	22
SZ-3-7-10mm	SC-314	SZ-7-10mm	10mm	2 1/4	57	1 3/8	35	7/8	22

1/2" Square Drive



Complete	Part Number		Hex Size	Overall Length		Length of Insert		Bit Length (A)	
	Adapter Only	Insert Only		In.	mm	In.	mm	In.	mm
SZ-5-7-4mm	SC-514	SZ-7-4mm	4mm	2 1/2	63	1 3/8	35	7/8	22
SZ-5-7-5mm	SC-514	SZ-7-5mm	5mm	2 1/2	63	1 3/8	35	7/8	22
SZ-5-7-6mm	SC-514	SZ-7-6mm	6mm	2 1/2	63	1 3/8	35	7/8	22
SZ-5-7-8mm	SC-514	SZ-7-8mm	8mm	2 1/2	63	1 3/8	35	7/8	22
SZ-5-7-10mm	SC-514	SZ-7-10mm	10mm	2 1/2	63	1 3/8	35	7/8	22
SZ-5-7-12mm	SC-514	SZ-7-12mm	12mm	2 1/2	63	1 3/8	35	7/8	22
SZ-5-7-14mm	SC-514	SZ-7-14mm	14mm	2 1/2	63	1 3/8	35	15/16	24
SZ-5-10-14mm	RP-520	SZ-10-14mm	14mm	2 1/2	63	1 9/16	40	29/32	23
SZ-5-10-17mm	RP-520	SZ-10-17mm	17mm	2 1/2	63	1 9/16	40	29/32	23
SZ-5-10-19mm	RP-520	SZ-10-19mm	19mm	2 1/2	63	1 9/16	40	29/32	23

3/4" Square Drive



Complete	Part Number		Hex Size	Overall Length		Length of Insert		Bit Length (A)	
	Adapter Only	Insert Only		In.	mm	In.	mm	In.	mm
SZ-7-10-10mm	RP-720	SZ-10-10mm	10mm	2 1/2	64	1 9/16	40	29/32	23
SZ-7-10-12mm	RP-720	SZ-10-12mm	12mm	2 1/2	64	1 9/16	40	29/32	23
SZ-7-10-14mm	RP-720	SZ-10-14mm	14mm	2 1/2	64	1 9/16	40	29/32	23
SZ-7-10-17mm	RP-720	SZ-10-17mm	17mm	2 1/2	64	1 9/16	40	29/32	23

1" Square Drive



Complete	Part Number		Hex Size	Overall Length		Length of Insert		Bit Length (A)	
	Adapter Only	Insert Only		In.	mm	In.	mm	In.	mm
SZ-8-14-17mm	RP-828	SZ-14-17mm	17mm	3 5/16	84	2	51	1 1/8	29
SZ-8-14-19mm	RP-828	SZ-14-19mm	19mm	3 5/16	84	2	51	1 1/8	29
SZ-8-14-22mm	RP-828	SZ-14-22mm	22mm	3 5/16	84	2	51	1 1/8	29
SZ-8-14-24mm	RP-828	SZ-14-24mm	24mm	3 5/16	84	2	51	1 1/8	29
SZ-8-14-27mm	RP-828	SZ-14-27mm	27mm	3 5/16	84	2	51	1 1/8	29

Square Recess Bits

1/4" Hex Insert Bits

Part Number	Point Size	Nominal Size In.	Overall Length In.	mm
950-0X	0	1/16	1	25
950-1X	1	3/32	1	25
950-2X	2	1/8	1	25
950-3X	3	9/64	1	25

1/4" Hex Power Drive

Part Number	Point Size	Nominal Size In.	Overall Length In.	mm
954-0X	0	1/16	1 15/16	49
954-A-0X	0	1/16	2 3/4	70
954-C-0X	0	1/16	6	152
954-1X	1	3/32	1 15/16	49
954-A-1X	1	3/32	2 3/4	70
954-B-1X	1	3/32	3 1/2	89
954-C-1X	1	3/32	6	152
954-2X	2	1/8	1 15/16	49
954-A-2X	2	1/8	2 3/4	70
954-B-2X	2	1/8	3 1/2	89
954-C-2X	2	1/8	6	152
954-3X	3	9/64	1 15/16	49
954-A-3X	3	9/64	2 3/4	70
954-B-3X	3	9/64	3 1/2	89
954-C-3X	3	9/64	6	152

1/4" Hex Power Drive – Turned Body

Part Number	Point Size	Nominal Size In.	Overall Length In.	mm	Turned Length In.	mm
1950-0X	0	1/16	1 15/16	49	1 1/4	32
1951-0X	0	1/16	2 3/4	70	2	51
1950-1X	1	3/32	1 15/16	49	1 1/4	32
1951-1X	1	3/32	2 3/4	70	2	51
1953-1X	1	3/32	3 1/2	89	2 3/4	70
1950-2X	2	1/8	1 15/16	49	1 1/4	32
1951-2X	2	1/8	2 3/4	70	2	51
1953-2X	2	1/8	3 1/2	89	2 3/4	70
1956-2X	2	1/8	6	152	5 1/8	130
1950-3X	3	9/64	1 15/16	49	1 1/4	32
1951-3X	3	9/64	2 3/4	70	2	51
1953-3X	3	9/64	3 1/2	89	2 3/4	70

Screw Size	3 & 4	5, 6, 7	8, 9, 10	12-14 1/4
Square Point Size	0	1	2	3

For Quad-rex bits refer to page 14.

Male Square Inserts for Pipe Plugs

1/4" to 1/2" Male Square

Part Number	Male Hex In.	Male Square In.	Overall Length In.	mm
P-1408	7/16	1/4	1 1/4	32
P-1409	7/16	9/32	1 1/4	32
P-1410	7/16	5/16	1 1/4	32
P-1412	7/16	3/8	1 1/4	32
P-1414	7/16	7/16	1 1/4	32
P-1416	7/16	1/2	1 1/4	32
P-2010	5/8	5/16	1 1/2	38
P-2012	5/8	3/8	1 1/2	38
P-2014	5/8	7/16	1 1/2	38
P-2016	5/8	1/2	1 1/2	38

Note: For pipe plug inserts use SC and RP bit holders found on page 26.

Triple Square Bits

1/4" Hex Insert Bits

Part Number	Point Size	Overall Length In.	mm
440-TSQ-4M	4mm	1	25
440-TSQ-5M	5mm	1	25
440-TSQ-6M	6mm	1	25
440-TSQ-8M	8mm	1	25
440-TSQ-10M	10mm	1	25

5/16" Hex Insert Bits

Part Number	Point Size	Overall Length In.	mm
480-TSQ-6M	6mm	1 1/4	32
480-TSQ-8M	8mm	1 1/4	32
480-TSQ-10M	10mm	1 1/4	32
480-TSQ-12M	12mm	1 1/4	32
480-TSQ-14M	14mm	1 1/4	32

1/4" Hex Power Drive

Part Number	Point Size	Overall Length In.	mm
49-TSQ-4M	4mm	2	50
49-TSQ-5M	5mm	2	50
49-TSQ-6M	6mm	2	50
49-TSQ-8M	8mm	2	50
49-TSQ-10M	10mm	2	50
49-TSQ-12M	12mm	2	50

7/16" Hex Power Drive

Part Number	Point Size	Overall Length In.	mm
48-TSQ-5M	5mm	3 1/2	88
48-TSQ-6M	6mm	3 1/2	88
48-TSQ-8M	8mm	3 1/2	88
48-TSQ-10M	10mm	3 1/2	88
48-TSQ-12M	12mm	3 1/2	88
48-TSQ-14M	14mm	3 1/2	88

Torq-Set® Bits

1/4" Hex Insert Bits

Part Number	Point Size	Overall Length In.	mm
212-0	0	1	25
212-1	1	1	25
212-2	2	1	25
212-3	3	1	25
212-4	4	1	25
212-5	5	1	25
212-6	6	1	25
212-8	8	1	25
212-10	10	1	25
212-1/4	1/4	1	25

1/4" Hex Insert Bits – ACR® Available with ACR® ribs for removal only

Part Number	Point Size	Overall Length In.	mm
212-6-ACR	6	1	32
212-8-ACR	8	1	32
212-10-ACR	10	1	32
212-1/4-ACR	1/4	1	32

5/16" Hex Insert Bits

Part Number	Point Size	Overall Length In.	mm
212-8A	8	1 1/4	32
212-10A	10	1 1/4	32
212-1/4A	1/4	1 1/4	32
212-5/16A	5/16	1 1/4	32
212-3/8A	3/8	1 1/4	32

5/16" Hex Insert Bits – ACR® Available with ACR® ribs for removal only

Part Number	Point Size	Overall Length In.	mm
212-1/4A-ACR	1/4	1 1/4	32
212-5/16A-ACR	5/16	1 1/4	32

Torq-Set[®] Bits 
1/4" Hex Power Drive

Part Number	Point Size	Overall Length	
		In.	mm
170-0	0	1 1/4	32
273-0	0	1 15/16	49
273B-0	0	2 3/4	70
265-0	0	3 1/2	89
265A-0	0	6	152
170-1	1	1 1/4	32
273A-1	1	1 13/16	46
273-1	1	1 15/16	49
273B-1	1	2 3/4	70
265-1	1	3 1/2	89
265A-1	1	6	152
170-2	2	1 1/4	32
273A-2	2	1 13/16	46
273-2	2	1 15/16	49
273B-2	2	2 3/4	70
265-2	2	3 1/2	89
265A-2	2	6	152
170-3	3	1 1/4	32
273A-3	3	1 13/16	46
273-3	3	1 15/16	49
273B-3	3	2 3/4	70
265-3	3	3 1/2	89
265A-3	3	6	152
170-4	4	1 1/4	32
273A-4	4	1 13/16	46
273-4	4	1 15/16	49
273B-4	4	2 3/4	70
265-4	4	3 1/2	89
265A-4	4	6	152
170-5	5	1 1/4	32
273-5	5	1 15/16	49
273B-5	5	2 3/4	70
265-5	5	3 1/2	89
265A-5	5	6	152
170-6	6	1 1/4	32
170-6-ACR*	6	1 1/4	32
273A-6	6	1 13/16	46
273-6	6	1 15/16	49
273B-6	6	2 3/4	70
265-6	6	3 1/2	89
265A-6	6	6	152
170-8	8	1 1/4	32
170-8-ACR*	8	1 1/4	32
273A-8	8	1 13/16	46
273-8	8	1 15/16	49
273B-8	8	2 3/4	70
265-8	8	3 1/2	89
265A-8	8	6	152
170-10	10	1 1/4	32
170-10-ACR*	10	1 1/4	32
273A-10	10	1 13/16	46
273-10	10	1 15/16	49
273B-10	10	2 3/4	70
265-10	10	3 1/2	89
265A-10	10	6	152
170-1/4B	1/4	1 1/4	32
170-5/16B	5/16	1 1/4	32
170-3/8B	3/8	1 1/4	32

*Feature ACR[®] anti-camout ribs.

Torq-Set[®], ACR[®] and Tri-Wing[®] are registered trademarks of the Phillips Screw Company.

5/16" Hex Power Drive

Part Number	Point Size	Overall Length	
		In.	mm
170-8A	8	1 1/4	32
170-10A	10	1 1/4	32
170-1/4A	1/4	1 1/4	32
170-5/16A	5/16	1 1/4	32
170-3/8A	3/8	1 1/4	32

7/16" Hex Power Drive

Part Number	Point Size	Overall Length	
		In.	mm
170-1/4	1/4	1 1/4	32
265-1/4	1/4	3 1/2	89
265A-1/4	1/4	6	152
170-5/16	5/16	1 1/4	32
265-5/16	5/16	3 1/2	89
265A-5/16	5/16	6	152
170-3/8	3/8	1 1/4	32
170-3/8C	3/8	1 1/4	32
265A-3/8	3/8	6	152
170-7/16	7/16	1 1/4	32
170-7/16C	7/16	1 1/4	32
265A-7/16	7/16	6	152

7/16" Hex Power Drive – ACR[®]
Available with ACR[®] ribs for removal only

Part Number	Point Size	Overall Length	
		In.	mm
170-1/4-ACR	1/4	1 1/4	32
170-5/16-ACR	5/16	1 1/4	32

5/8" Hex Power Drive

Part Number	Point Size	Overall Length	
		In.	mm
170-1/2	1/2	1 1/4	32
170-9/16	9/16	1 1/4	32
170-5/8	5/8	1 1/4	32

MorTorq[®] Bits 

Part Number	Driver Size/Type	MorTorq Size	Overall Length	
			In.	mm
440-MT-00	1/4" Hex Insert	00	1	25
440-MT-0	1/4" Hex Insert	0	1	25
440-MT-1	1/4" Hex Insert	1	1	25
440-MT-2	1/4" Hex Insert	2	1	25
480-MT-3	5/16" Hex Insert	3	1 1/4	31
AM-MT-0	1/4" Hex Power	0	1 15/16	31
AM-MT-1	1/4" Hex Power	1	1 15/16	31
AM-MT-2	1/4" Hex Power	2	1 15/16	31
AN-MT-3	7/16" Hex Power	3	3 1/2	89
AN-MT-4	7/16" Hex Power	4	3 1/2	89

Other drive sizes/types and point sizes can be quoted. Contact your Apex Distributor or Representative for more information. MorTorq[®] is a registered trademark of Phillips Screw Company.

Tri-Wing[®] 

1/4" Hex Insert Bits

Part Number	Recess Size	Screw Size Tension Head	Screw Size Shear Head	Overall Length	
				In.	mm
TWD-0	0	0-80	-	1	25
TWD-1	1	2-56	4-40	1	25
TWD-2	2	4-40	6-32	1	25
TWD-3	3	6-32	8-32	1	25
TWD-4	4	8-32	10-32	1	25
TWD-5	5	10-32	1/4-28	1	25
TWD-6	6	1/4	5/16	1	25
TWD-7	7	5/16	3/8	1	25

1/4" Hex Insert Bits – ACR[®]
Available with ACR[®] ribs for removal only

Part Number	Recess Size	Screw Size Tension Head	Screw Size Shear Head	Overall Length	
				In.	mm
TWD-4-ACR	4	8-32	10-32	1	25
TWD-5-ACR	5	10-32	1/4-28	1	25

5/16" Hex Insert Bit

Part Number	Recess Size	Screw Size Tension Head	Screw Size Shear Head	Overall Length	
				In.	mm
TWE-4	4	8-32	10-32	1 1/4	32
TWE-5	5	10-32	1/4-28	1 1/4	32

1/4" Hex Power Drive

Part Number	Recess Size	Screw Size Tension Head	Screw Size Shear Head	Overall Length	
				In.	mm
TW-0	0	0-80	-	1 1/4	32
TW-1	1	2-56	4-40	1 1/4	32
TW-2	2	4-40	6-32	1 1/4	32
TW-3	3	6-32	8-32	1 1/4	32
TW-4	4	8-32	10-32	1 1/4	32
TW-5	5	10-32	1/4-28	1 1/4	32
TWB-6	6	1/4-28	5/16-24	1 1/2	38
TWB-7	7	5/16-24	3/8-24	1 1/2	38
TWB-8	8	3/8-24	7/16-20	1 1/2	38

5/16" Hex Power Drive

Part Number	Recess Size	Screw Size Tension Head	Screw Size Shear Head	Overall Length	
				In.	mm
TWA-6	6	1/4-28	5/16-24	1 1/4	32
TWA-7	7	5/16-24	3/8-24	1 1/4	32
TWA-8	8	3/8-24	7/16-20	1 1/4	32

7/16" Hex Power Drive

Part Number	Recess Size	Screw Size Tension Head	Screw Size Shear Head	Overall Length	
				In.	mm
TW-6	6	1/4-28	5/16-24	1 1/4	32
TW-7	7	5/16-24	3/8-24	1 1/4	32

Hi-Torque[®] Bits 

1/4" Square Drive Insert Bits

Part Number	Recess	Overall Length In.	Body Diameter In.	Blade	Blade
				Thickness In.	Width In.
HTS-0	0	1	1/2	.029	.167
HTS-1	1	1	1/2	.049	.274
HTS-2	2	1	1/2	.059	.295
HTS-3	3	1	1/2	.059	.377
HTS-4	4	1	1/2	.073	.502

3/8" Square Drive Insert Bits

Part Number	Recess	Overall Length In.	Body Diameter In.	Blade	Blade
				Thickness In.	Width In.
HTS-3A	3	1 1/4	3/4	.059	.377
HTS-4A	4	1 1/4	3/4	.073	.502
HTS-5	5	1 1/4	3/4	.079	.629
HTS-6	6	1 1/4	3/4	.095	.745

1/2" Square Drive Insert Bits

Part Number	Recess	Overall Length In.	Body Diameter In.	Blade	Blade
				Thickness In.	Width In.
HTS-7	7	1 5/8	1	.112	.884
HTS-8	8	1 5/8	1	.142	.995
HTS-9	9	1 5/8	1 1/4	.162	1.136
HTS-10	10	1 5/8	1 1/4	.182	1.250
HTS-12	12	2 3/8	1 1/4	.216	1.500

1/4" Hex Insert Bits

Part Number	Recess	Overall Length In.	Body Diameter In.	Blade	Blade
				Thickness In.	Width In.
HTN-B-1	1	1 1/4	9/32	.049	.274
HTN-B-2	2	1 1/4	5/16	.059	.295
HTN-B-3	3	1 1/4	3/8	.059	.377
HTN-B-4	4	1 1/4	1/2	.073	.502

Nominal Screw Size	0	1	2	3	4	5	6	8	10	1/4	5/16	3/8	7/16	1/2	9/16	5/8	3/4
Hi-Torque Recess	0	0	0	1	1	1	1	2	3	4	5	6	7	8	9	10	12

Hi-Torque[®]—Rudy Vaughn, Licensor

APEX® Solutions

Does Apex offer magnetic bit holders?

Bit holders, like this Apex M-490, let you use a variety of insert bits in power tool applications. You get economy and flexibility – and fasteners can be magnetically held to the bit.

(See pages 25-26)



If the tool you need does not appear in this catalog, give us a call. The odds are, we may have what you need as a non-catalog item. If not, our experienced staff of tooling experts can design and manufacture “specials” to meet the needs of your specific application. Give us a call at 1-800-845-5629 or visit our website www.apex-tools.com.

Do Apex quick-release bit holders hold bits securely?

A quick-release bit holder allows fast, easy insert bit changes while assuring that bits stay securely in the bit holder. Simply pull back on the knurled sleeve to release the bit.

(See page 25)



Does Apex offer quick release chucks?

Apex has a complete line of quick release chucks that provide fast and easy power bit changes.

(See page 26)





Bit Holders

1/4" Hex Drive for 1/4" Hex Inserts

Part Number	Overall Length	
	In.	mm
		
Non-magnetic		
490	2 1/8	54
490-3	3	76
490-4	4	102
490-5	5	127
490-6	6	152
490-8	8	203
490-10	10	254

Part Number	Overall Length		
	In.	mm	
			
M-490-2	2	51	Magnetic
M-490-NR	2 31/32	75	Magnetic; No lock ring
M-490	2 31/32	75	Magnetic
M-497	3 3/32	79	Magnetic; 3/8" (9.5mm) reduced dia.
M-490-4	4	102	Magnetic
M-490-6	6	152	Magnetic
M-490-8	8	203	Magnetic
M-490-10	10	254	Magnetic
M-490-12	12	304	Magnetic
M-44-90	3 1/4	83	Magnetic; for Flip-Tip™ reversible bits

Part Number	Overall Length		
	In.	mm	
			
M-495	2 7/8	73	Magnetic; 3/8" (9.5mm) turned shank
M-495-5	5	127	Magnetic; 3/8" (9.5mm) turned shank

Part Number	Overall Length		
	In.	mm	
			
RM-490	2 7/8	73	Magnetic; nose piece only, #490-RN
RM-490-4	4	102	Magnetic; nose piece only, #490-RN
RM-490-6	6	152	Magnetic; nose piece only, #490-RN

Part Number	Overall Length		
	In.	mm	
			
M-490-2-OR	2	51	Magnetic; with O-Ring retainer
M-490-OR	3	76	Magnetic; with O-Ring retainer

1/4" Hex Drive for 1/4" Hex Inserts, Quick Release

Part Number	Overall Length		
	In.	mm	
			
QR-M-490-2	2	51	Magnetic; quick release
QR-M-490-A	2 29/32	74	Magnetic; quick release
QR-M-490-A6	6	152	Magnetic; quick release
QR-M-490-200M	7 7/8	200	Magnetic; quick release

1/4" Hex Drive for 5/16" Hex Inserts

Part Number	Overall Length		
	In.	mm	
			
498	2 3/8	60	
M-498	3 1/16	78	Magnetic

5/16" Hex Drive

Part Number	Overall Length		
	In.	mm	
			
630	1 13/16	46	For 1/4" hex inserts
M-630	3	76	For 1/4" hex inserts; magnetic
638	2 1/2	64	For 5/16" hex inserts
M-638	3 3/32	79	For 5/16" hex inserts; magnetic

5/16" Buckeye-Desoutter for 1/4" Hex Inserts

Part Number	Overall Length		
	In.	mm	
			
610	2	51	
M-610	3 3/16	81	Magnetic

7/16" Hex Drive

Part Number	Overall Length		
	In.	mm	
			
488	2 3/4	70	For 1/4" hex inserts
M-488	3 1/16	78	For 1/4" hex inserts; magnetic
480	2 3/4	70	For 5/16" hex inserts
M-480	3 5/16	84	For 5/16" hex inserts; magnetic
M-480-6	6	152	For 5/16" hex inserts; magnetic

9/32" 130-A Yankee Type for 1/4" Hex Inserts

Part Number	Overall Length		
	In.	mm	
			
450	2 1/4	57	
M-450	3 3/8	86	Magnetic

5/16" 131-A Yankee Type for 1/4" Hex Inserts

Part Number	Overall Length		
	In.	mm	
			
460	2 1/4	57	
M-460	3 3/8	86	Magnetic

7/32" 135-A Yankee Type for 1/4" Hex Inserts

Part Number	Overall Length		
	In.	mm	
			
M-470	3 3/8	86	Magnetic

1/4"-24 Screw Shank for 1/4" Hex Inserts

Part Number	Overall Length		
	In.	mm	
			
400-BH	1 1/8	29	

Bit Holders

1/4" Female Square Drive



Part Number	Overall Length		
	In.	mm	
825	1	25	For 1/4" hex inserts
M-825	2 9/32	58	For 1/4" hex inserts; magnetic
820	23/32	18	For 1/4" square inserts

3/8" Female Square Drive



Part Number	Overall Length		
	In.	mm	
838	1 1/2	38	For 1/4" hex inserts
M-838	2 23/32	69	For 1/4" hex inserts; magnetic
835	1 1/2	38	For 5/16" hex inserts
M-835	2 3/4	70	For 5/16" hex inserts; magnetic
830	1 1/2	38	For 5/16" square inserts

1/2" Female Square Drive



Part Number	Overall Length		
	In.	mm	
858	1 3/4	45	For 1/4" hex inserts
M-858	2 3/4	70	For 1/4" hex inserts; magnetic
855	1 3/4	45	For 5/16" hex inserts
M-855	2 3/4	70	For 5/16" hex inserts; magnetic
850	1 3/4	45	For 5/16" square inserts

Bit Holders/Adapters with Set Screw or Thru Hole

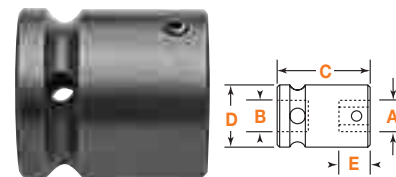

Part Number	Set Screw Lock	Spring Pin Retainer	Spring Only	Hex Square		Overall Length (C)	Body Dia. (D)		Opening Depth (E)			
				(A) In.	(B) In.		In.	mm				
SC-108				1/4	1/4	1 1/4	32	3/4	19	5/8	16	
SC-308				1/4	3/8	1 1/2	38	3/4	19	5/8	16	
SC-508				1/4	1/2	1 1/2	38	7/8	22	5/8	16	
SC-114					7/16	1/4	1	25	3/4	19	17/32	13
SC-314	RP-314	21-S-156-0750		7/16	3/8	1 3/8	35	3/4	19	17/32	13	
SC-514	RP-514	21-S-156-0937		7/16	1/2	1 5/8	41	15/16	24	17/32	13	
SC-614	RP-614	21-S-156-0375		7/16	5/8	1 3/4	46	1 1/4	32	17/32	13	
SC-520	RP-520	21-S-187-1125		5/8	1/2	1 1/2	38	1 1/8	29	11/16	17	
SC-620	RP-620	21-S-187-1250		5/8	5/8	1 1/2	38	1 1/4	32	11/16	17	
SC-720	RP-720	21-S-187-1500		5/8	3/4	1 11/16	43	1 1/2	38	11/16	17	
SC-820	RP-820	21-S-187-1375		5/8	1	2 1/8	54	2 1/8	54	11/16	17	
SC-724	RP-724	21-S-187-1500		3/4	3/4	2	51	1 5/8	42	7/8	22	
SC-728	RP-728	21-S-187-1625		7/8	3/4	2	51	1 5/8	42	57/64	23	
SC-828	RP-828	21-S-187-1625		7/8	1	2 1/8	54	2 1/8	54	5/8	23	

Note: Use SC bit holders with socket head inserts (page 19) and pipe plug inserts (page 21). Can be used with power bits.

Female Threaded Drive, Quick Releasing Chucks



Part Number	Female Thread	Hex Opening In.	Overall Length		Overall Diameter		Opening Depth	
			In.	mm	In.	mm	In.	mm
QRA-08	3/8"-24	1/4	1 3/4	45	3/4	19	61/64	24
QRA-14	3/8"-24	7/16	2	51	1 1/4	32	1 1/16	27
QRF-08	1/2"-20	1/4	1 3/4	45	3/4	19	61/64	24
QRF-14	1/2"-20	7/16	2	51	1 1/4	32	1 1/16	27
QRF-20	1/2"-20	5/8	2 5/8	67	1 5/8	41	1 1/2	38

Female Square Drive, Quick Releasing Chucks

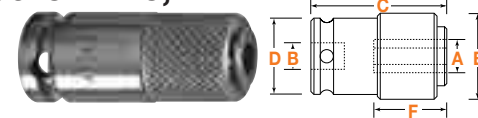

Part Number	Hex Open. (A) In.	Square Drive (B) In.	Overall Length (C)		Body Diameter (D)		Sleeve Diameter (E)		Opening Depth (F)	
			In.	mm	In.	mm	In.	mm	In.	mm
QR-108	1/4	1/4	1 1/2	38	3/4	19	3/4	19	61/64	24
QR-308	1/4	3/8	1 3/4	45	3/4	19	3/4	19	61/64	24
QR-508	1/4	1/2	2 1/8	54	7/8	22	3/4	19	61/64	24
QR-314	7/16	3/8	2	51	1	25	1 1/4	32	1 3/32	28
QR-514	7/16	1/2	2 1/8	54	1	25	1 1/4	32	1 1/16	27
QR-614	7/16	5/8	2 1/8	54	1 1/4	32	1 1/4	32	1 1/16	27
QR-714	7/16	3/4	2 3/8	60	1 1/2	38	1 1/4	32	1 1/16	27
QR-520	5/8	1/2	2 5/8	67	1 1/2	38	1 5/8	41	1 1/2	38
QR-620	5/8	5/8	2 5/8	67	1 1/2	38	1 5/8	41	1 1/2	38
QR-720	5/8	3/4	3 1/8	79	1 1/2	38	1 5/8	41	1 1/2	38
QR-820	5/8	1	3 1/4	83	2 1/8	54	1 5/8	41	1 1/2	38
QR-824	3/4	1	3 3/4	95	2	51	1 7/8	48	1 5/8	41

1/4" Hex Drive Nutsetters for Sheet Metal Screws

6 Point Power Drive, SAE



Part Number	Size In.	Overall Length In.	Socket Nose Diameter		
			In.	In.	
DB-08	1/4	2 9/16	7/16		Non-magnetic
DB-10	5/16	2 9/16	1/2		Non-magnetic
DB-12	3/8	2 9/16	9/16		Non-magnetic
MDA-08	1/4	1 3/4	7/16		Magnetic
MDAT-08	1/4	1 3/4	3/8		Magnetic
MDA-10	5/16	1 3/4	1/2		Magnetic
MDA-12	3/8	1 3/4	9/16		Magnetic
MDA-14	7/16	2	11/16		Magnetic
MDB-08	1/4	2 9/16	7/16		Magnetic 5/16" Shank Diameter
MDB-10	5/16	2 9/16	1/2		Magnetic 5/16" Shank Diameter
MDB-12	3/8	2 9/16	9/16		Magnetic 5/16" Shank Diameter
MDB-14	7/16	2 9/16	5/8		Magnetic 5/16" Shank Diameter
MDC-08	1/4	2 9/16	7/16		Magnetic 3/8" Shank Diameter
MDC-10	5/16	2 9/16	1/2		Magnetic 3/8" Shank Diameter
MDC-12	3/8	2 9/16	9/16		Magnetic 3/8" Shank Diameter

6 Point Insert, SAE



Part Number	Size In.	Overall Length In.	Socket Nose Diameter		
			In.	In.	
MHM-1310	5/16	1 1/8	1/2		Magnetic
MHM-1912	3/8	1 3/4	9/16		Magnetic

6 Point Power Drive, Metric



Part Number	Size In.	Overall Length In.	Socket Nose Diameter		
			In.	In.	
MDA-6mm	6	44.5	9.5		Magnetic
MDA-7mm	7	44.5	11.1		Magnetic
MDA-8mm	8	44.5	12.7		Magnetic
MDA-10mm	10	44.5	14.3		Magnetic
MDA-10mm-80m	10	80.0	14.3		Magnetic

6 Point Insert, Metric



Part Number	Size In.	Overall Length In.	Socket Nose Diameter		
			In.	In.	
MHM-7mm	7	31.8	11.1		Magnetic
MHM-8mm	8	31.8	12.7		Magnetic
MHM-10mm	10	31.8	14.3		Magnetic

1/4" Hex Drive Nutsetters

6 Point and 6 Point Magnetic, SAE



Part Number	Part Number Magnetic	Size In.	Overall Length In.	Socket Nose Diameter In.
6N-0806-3	M6N-0806-3	3/16	3	5/16
-	M6N-0806-5	3/16	5	5/16
-	M6N-0806-6	3/16	6	5/16
6N-0808-2	M6N-0808-2	1/4	2	7/16
6N-0808-3	M6N-0808-3	1/4	3	7/16
6N-0808-4	M6N-0808-4	1/4	4	7/16
6N-0808-5	M6N-0808-5	1/4	5	7/16
6N-0808-6	M6N-0808-6	1/4	6	7/16
6N-0810-2	M6N-0810-2	5/16	2	1/2
6N-0810-3	M6N-0810-3	5/16	3	1/2
6N-0810-4	M6N-0810-4	5/16	4	1/2
6N-0810-5	M6N-0810-5	5/16	5	1/2
6N-0810-6	M6N-0810-6	5/16	6	1/2
6N-0811-2	M6N-0811-2	11/32	2	9/16
6N-0811-3	M6N-0811-3	11/32	3	9/16
6N-0812-2	M6N-0812-2	3/8	2	9/16
6N-0812-3	M6N-0812-3	3/8	3	9/16
6N-0812-4	M6N-0812-4	3/8	4	9/16
6N-0812-6	M6N-0812-6	3/8	6	9/16
6N-0814-2	M6N-0814-2	7/16	2	21/32
6N-0814-3	M6N-0814-3	7/16	3	21/32
6N-0814-4	M6N-0814-4	7/16	4	21/32
6N-0814-6	M6N-0814-6	7/16	6	21/32
6N-0816-2	M6N-0816-2	1/2	2	3/4
6N-0816-3	M6N-0816-3	1/2	3	3/4
6N-0818-2	M6N-0818-2	9/16	2	13/16

6 Point and 6 Point Magnetic, Metric



Part Number	Part Number Magnetic	Size mm	Overall Length mm	Socket Nose Diameter mm
6N-08-8M-4	M6N-08-8M-4	8	102	12.7
6N-08-8M-6	M6N-08-8M-6	8	152	12.7
6N-08-10M-3	M6N-08-10M-3	10	76	14.3
6N-08-10M-4	M6N-08-10M-4	10	102	14.3
6N-08-10M-6	M6N-08-10M-6	10	76	14.3
6N-08-12M-3	M6N-08-12M-3	12	76	19.0
6N-08-12M-4	M6N-08-12M-4	12	102	19.0
6N-08-12M-6	M6N-08-12M-6	12	152	19.0

1/4" Hex Drive Nutsetters

6 Point, Bolt Clearance



Part Number	Size In.	Overall Length In.	Socket Nose Diameter In.	Depth of Clearance (A) In.
6B-0808	1/4	3 1/4	7/16	1 3/8
6B-0809	9/32	3 1/4	1/2	1 3/8
6B-0810	5/16	3 1/4	1/2	1 3/8
6B-0811	11/32	3 1/4	9/16	1 3/8
6B-0812	3/8	3 1/4	9/16	1 3/8
6B-0814	7/16	3 1/4	21/32	1 3/8
6B-0816	1/2	3 1/4	3/4	1 3/8
6B-0818	9/16	3 1/4	13/16	1 3/8
6B-0820	5/8	3 1/4	7/8	1 3/8

See bolt clearance Tool Tip page 32.

7/16" Hex Drive Nutsetters

6 Point



Part Number	Size In.	Overall Length In.	Socket Nose Diameter In.
6N-1410-3	5/16	3	9/16
6N-1412-3	3/8	3	9/16
6N-1414-3	7/16	3	3/4
6N-1416-3	1/2	3	13/16
6N-1416-4	1/2	4	13/16
6N-1418-3	9/16	3	7/8
6N-1418-6	9/16	6	7/8
6N-1420-3	5/8	3	1
6N-1424-3	3/4	3	1 1/8
6N-1424-6	3/4	6	1 1/8

5/8" Hex Drive Nutsetters

6 Point



Part Number	Size In.	Overall Length In.	Socket Nose Diameter In.
6N-2028-4	7/8	4	1 3/8
6N-2036-4	1 1/8	4	1 5/8

Hand Drivers

Drivers with Self-Contained Insert Bits



Part No.	Female Hex Size	Overall Length In.	Overall Length mm	Blade Projection In.	Blade Projection mm	
M-15-SC	1/4	8 1/2	216	4 3/8	111	Phillips #1, #2, #3; Slotted 4F-5R, 10F-12R; hollow handle.
M-15-SC-A	1/4	8 1/2	216	4 3/8	111	Without bits; hollow handle.

Replaceable Bit Drivers



Part No.	Female Hex Size	Overall Length In.	Overall Length mm	Blade Projection In.	Blade Projection mm
1510-P	1/4	2 3/4	70	7/8	22
1500-P	1/4	7 1/2	191	3 9/32	83

Replaceable Bit Drivers – Magnetic



Part No.	Female Hex Size	Overall Length In.	Overall Length mm	Blade Projection In.	Blade Projection mm
M-1505-P	1/4	2 3/8	60	3/8	10
M-1500-P	1/4	8 1/2	216	4 3/8	111



24 Bit Kit

Industrial Bit Kit

Tool kit includes plastic carrying case with: Magnetic hand driver and magnetic bit holder.
Phillips bits: #1, #2, #3
Slotted bits: 3F-4R, 4F-5R, 6F-8R, 8F-10R, 10F-12R
Torx® bits: T-10, T-15, T-20, T-25, T-27, T-30, T-40
Square Recess bits: 3/32", 1/8"
Hex bits: 5/64", 3/32", 7/64", 1/8", 9/64"
Pozidriv® bits: #1, #2

Awls



Part Number	Overall Length In.	Overall Length mm	Shank Diameter In.	Shank Diameter mm
AW-95	7 7/16	189	.307	7.8
AW-95-L	8	203	.307	7.8
AW-95-LL	8 7/8	225	.307	7.8

Use awls to line up holes and scratch mark surfaces.

Hex Extensions

Male Hex Drive with 1/4" Male Square



Part Number	Hex Drive In.	Type of Lock	Overall Length In.	Overall Length mm
EX-250	1/4	Pin	1 3/8	35
EX-250-B	1/4	Ball	1 3/8	35
EX-250-2	1/4	Pin	2	51
EX-250-B-2	1/4	Ball	2	51
EX-250-3	1/4	Pin	3	76
EX-250-B-3	1/4	Ball	3	76
EX-250-4	1/4	Pin	4	102
EX-250-B-4	1/4	Ball	4	102
EX-250-5	1/4	Pin	5	127
EX-250-B-5	1/4	Ball	5	127
EX-250-6	1/4	Pin	6	152
EX-250-B-6	1/4	Ball	6	152
EX-250-8	1/4	Pin	8	203
EX-250-B-8	1/4	Ball	8	203
EX-250-12	1/4	Pin	12	305
EX-250-B-12	1/4	Ball	12	305
EX-262	5/16	Pin	1 1/2	38
EX-262-4	5/16	Pin	4	102
EX-262-B-4	5/16	Ball	4	102
EX-262-6	5/16	Pin	6	152
EX-251	7/16	Pin	1 3/8	35
EX-251-B	7/16	Ball	1 3/8	35
EX-251-2	7/16	Pin	2	51
EX-251-B-2	7/16	Ball	2	51
EX-251-3	7/16	Pin	3	76
EX-251-6	7/16	Pin	6	152
EX-251-8	7/16	Pin	8	203
EX-251-10	7/16	Pin	10	254

Male Hex Drive with 3/8" Male Square



Part Number	Hex Drive In.	Type of Lock	Overall Length In.	Overall Length mm
EX-370	1/4	Pin	1 5/8	41
EX-370-B	1/4	Ball	1 5/8	41
EX-370-2	1/4	Pin	2	51
EX-370-B-2	1/4	Ball	2	51
EX-370-3	1/4	Pin	3	76
EX-370-B-3	1/4	Ball	3	76
EX-370-4	1/4	Pin	4	102
EX-370-B-4	1/4	Ball	4	102
EX-370-5	1/4	Pin	5	127
EX-370-6	1/4	Pin	6	152
EX-370-B-6	1/4	Ball	6	152
EX-370-8	1/4	Pin	8	203
EX-370-B-8	1/4	Ball	8	203
EX-370-10	1/4	Pin	10	254
EX-370-B-10	1/4	Ball	10	254
EX-380	5/16	Pin	1 1/2	38
EX-380-B	5/16	Ball	1 1/2	38
EX-380-2	5/16	Pin	2	51
EX-380-B-2	5/16	Ball	2	51
EX-380-3	5/16	Pin	3	76
EX-380-4	5/16	Pin	4	102
EX-380-6	5/16	Pin	6	152
EX-371	7/16	Pin	1 3/4	45
EX-371-2	7/16	Pin	2	51
EX-371-2 3/4	7/16	Pin	2 3/4	70
EX-371-3	7/16	Pin	3	76
EX-371-B-3	7/16	Ball	3	76
EX-371-4	7/16	Pin	4	102
EX-371-5	7/16	Pin	5	127
EX-371-6	7/16	Pin	6	152
EX-371-8	7/16	Pin	8	203
EX-371-10	7/16	Pin	10	254
EX-371-12	7/16	Pin	12	305
EX-371-15	7/16	Pin	15	381

Hex Extensions

Male Hex Drive with 1/2" Male Square



Part Number	Hex Drive In.	Type of Lock	Overall Length In.	Overall Length mm
EX-500-2	1/4	Pin	2	51
EX-500-B-2	1/4	Ball	2	51
EX-500-3	1/4	Pin	3	76
EX-500-B-3	1/4	Ball	3	76
EX-500-4	1/4	Pin	4	102
EX-500-B-4	1/4	Ball	4	102
EX-500-6	1/4	Pin	6	152
EX-500-B-6	1/4	Ball	6	152
EX-512-2	5/16	Pin	2	51
EX-512-B-2	5/16	Ball	2	51
EX-512-3	5/16	Pin	3	76
EX-512-B-4	5/16	Ball	4	102
EX-501-2	7/16	Pin	2 1/8	54
EX-501-B-2	7/16	Ball	2 1/8	54
EX-501-3	7/16	Pin	3	76
EX-501-B-3	7/16	Ball	3	76
EX-501-4	7/16	Pin	4	102
EX-501-B-4	7/16	Ball	4	102
EX-501-5	7/16	Pin	5	127
EX-501-B-5	7/16	Ball	5	127
EX-501-6	7/16	Pin	6	152
EX-501-B-6	7/16	Ball	6	152
EX-501-8	7/16	Pin	8	203
EX-501-B-8	7/16	Ball	8	203
EX-501-10	7/16	Pin	10	254
EX-501-B-10	7/16	Ball	10	254
EX-501-12	7/16	Pin	12	305
EX-501-B-12	7/16	Ball	12	305
EX-501-15	7/16	Pin	15	381
EX-502	5/8	Pin	2	51
EX-502-B	5/8	Ball	2	51
EX-502-3	5/8	Pin	3	76
EX-502-B-3	5/8	Ball	3	76
EX-502-B-4	5/8	Ball	4	102
EX-502-5	5/8	Pin	5	127
EX-502-6	5/8	Pin	6	152
EX-502-8	5/8	Pin	8	203

Male Hex Drive with 5/8" Male Square



Part Number	Hex Drive In.	Type of Lock	Overall Length In.	Overall Length mm
EX-620-3	7/16	Pin	3	76
EX-620-6	7/16	Pin	6	152
EX-621-3	5/8	Pin	3	76
EX-621-B-3	5/8	Ball	3	76
EX-621-6	5/8	Pin	6	152
EX-621-8	5/8	Pin	8	203

Male Hex Drive with 3/4" Male Square



Part Number	Hex Drive In.	Type of Lock	Overall Length In.	Overall Length mm
EX-757-3	7/16	7/32 Drill Hole	3	76
EX-757-B-3	7/16	Ball	3	76
EX-758-4	5/8	7/32 Drill Hole	4	102
EX-758-B-4	5/8	Ball	4	102
EX-758-6	5/8	7/32 Drill Hole	6	152
EX-758-9	5/8	7/32 Drill Hole	9	229

Extensions

Threaded Screw Shank



Part Number	Male Square In.	Male Thread In.	Overall Length In.	Overall Length mm	Body Diameter In.	Body Diameter mm
TH-256	1/4	1/4-28	1 5/8	41	7/16	11
TH-376	3/8	1/4-28	1 5/8	41	1/2	13
TH-250	1/4	1/4-24	1 5/8	41	7/16	11
TH-370	3/8	1/4-24	1 3/4	45	1/2	13
TH-372	3/8	1/4-20	1 3/4	45	1/2	13

1/4" Male Hex Universal Wrenches

SAE 6 Point, Standard & Tension Type – Extension

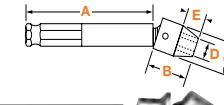

Part Number Standard	Part Number Tension	Hex Opening In.	Shank Length (A) In.	Socket Length (B) In.	Socket Diameter (C) In.	Nose End Diameter (D) In.	Clearance Depth (E) In.
KC-25-3	-	1/4	3	3/4	5/8	3/8	3/8
KC-25-4	-	1/4	4	3/4	5/8	3/8	3/8
KC-25-6	KS-25-6	1/4	6	3/4	5/8	3/8	3/8
KC-25-9	-	1/4	9	3/4	5/8	3/8	3/8
KC-25-12	-	1/4	12	3/4	5/8	3/8	3/8
KC-26-3	-	5/16	3	3/4	5/8	7/16	3/8
KC-26-6	KS-26-6	5/16	6	3/4	5/8	7/16	3/8
KC-26-9	-	5/16	9	3/4	5/8	7/16	3/8
KC-26-12	KS-26-12	5/16	12	3/4	5/8	7/16	3/8
-	KS-100-6	5/16	6	3/4	3/4	7/16	5/16
KC-27-3	-	11/32	3	3/4	5/8	1/2	3/8
KC-27-6	-	11/32	6	3/4	5/8	1/2	3/8
KC-101-6	-	11/32	6	3/4	3/4	15/32	5/16
KC-28-3	-	3/8	3	13/16	5/8	9/16	7/16
KC-28-6	KS-28-6	3/8	6	13/16	5/8	9/16	7/16
-	KS-28-12	3/8	12	13/16	5/8	9/16	7/16
-	KS-102-6	3/8	6	13/16	3/4	9/16	3/8
KC-29-3	-	7/16	3	7/8	5/8	5/8	1/2
KC-29-6	KS-29-6	7/16	6	7/8	5/8	5/8	1/2
KC-30-3	-	1/2	3	7/8	11/16	11/16	1/2
KC-30-4	-	1/2	4	7/8	11/16	11/16	1/2
KC-30-6	KS-30-6	1/2	6	7/8	11/16	11/16	1/2
KC-30-9	-	1/2	9	7/8	11/16	11/16	1/2
-	KS-104-6	1/2	6	1	3/4	3/4	9/16
KC-105-6	KS-105-6	9/16	6	1	13/16	13/16	9/16
-	KS-105-9	9/16	9	1	13/16	13/16	9/16

Metric 6 Point, Standard & Tension Type – Extension

Part Number Standard	Part Number Tension	Hex Opening mm	Shank Length (A) mm	Socket Length (B) mm	Socket Diameter (C) mm	Nose End Diameter (D) mm	Clearance Depth (E) mm
KC-5-7m-4	-	7	102	19.1	15.9	10.3	9.5
KC-5-7m-6	KS-5-7m-6	7	152	19.1	15.9	10.3	9.5
-	KS-5-7m-9	7	229	19.1	15.9	10.3	9.5
KC-6-8m-3	-	8	76	19.1	19.1	11.1	7.9
KC-6-8m-4	-	8	102	19.1	19.1	11.1	7.9
KC-6-8m-6	KS-6-8m-6	8	152	19.1	19.1	11.1	7.9
-	KS-6-8m-9	8	229	19.1	19.1	11.1	7.9
KC-6-9m-6	-	9	152	19.1	19.1	12.7	7.9
KC-6-10m-3	-	10	76	20.6	19.1	15.1	9.5
KC-6-10m-4	-	10	102	20.6	19.1	15.1	9.5
KC-6-10m-6	KS-6-10m-6	10	152	20.6	19.1	15.1	9.5
KC-6-10m-9	KS-6-10m-9	10	229	20.6	19.1	15.1	9.5
KC-6-10m-12	-	10	305	20.6	19.1	15.1	9.5
KC-7-11m-6	KS-7-11m-6	11	152	23.8	22.2	15.9	10.3
KC-7-12m-3	-	12	76	23.8	22.2	17.5	10.3
KC-7-12m-6	-	12	152	23.8	22.2	17.5	10.3
KC-7-12m-9	-	12	229	23.8	22.2	17.5	10.3
KC-7-13m-3	-	13	76	25.4	22.2	17.5	11.9
KC-7-13m-6	KS-7-13m-6	13	152	25.4	22.2	17.5	11.9
KC-7-13m-9	KS-7-13m-9	13	229	25.4	22.2	17.5	11.9

Actual design of universal wrenches may not be exactly like pictures above.

Universal wrenches must not be used with impact drivers. Maximum operating angle is 30°.-

7/16" Male Hex Universal Wrenches

SAE 6 Point, Standard & Tension Type – Extension

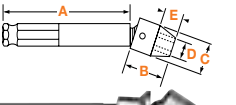

Part Number Standard	Part Number Tension	Hex Opening In.	Shank Length (A) In.	Socket Length (B) In.	Socket Diameter (C) In.	Nose End Diameter (D) In.	Clearance Depth (E) In.
KB-43-6	-	3/8	6	13/16	5/8	7/32	7/16
-	KT-44-6	7/16	6	7/8	5/8	5/8	1/2
KB-45-3	-	1/2	3	7/8	11/16	11/16	1/2
KB-45-4	-	1/2	4	7/8	11/16	11/16	1/2
KB-104-6	KT-104-6	1/2	6	1	3/4	3/4	9/16
KB-202-6	KT-202-6	1/2	6	1	7/8	11/16	15/32
-	KT-202-9	1/2	9	1	7/8	11/16	15/32
KB-202-12	KT-202-12	1/2	12	1	7/8	11/16	15/32
KB-317-9	KT-317-9	1/2	9	1	1	11/16	7/16
KB-105-3	-	9/16	3	1	13/16	13/16	9/16
-	KT-105-6	9/16	6	1	13/16	13/16	9/16
-	KT-105-9	9/16	9	1	13/16	13/16	9/16
-	KT-105-12	9/16	12	1	13/16	13/16	9/16
-	KT-203-6	9/16	6	1 1/16	7/8	3/4	17/32
KB-203-9	KT-203-9	9/16	9	1 1/16	7/8	3/4	17/32
KB-203-12	KT-203-12	9/16	12	1 1/16	7/8	3/4	17/32
-	KT-318-6	9/16	6	1 1/8	1	3/4	9/16
KB-318-12	-	9/16	12	1 1/8	1	3/4	9/16
KB-205-6	KT-205-6	5/8	6	1 1/8	7/8	7/8	19/32
KB-205-12	KT-205-12	5/8	12	1 1/8	7/8	7/8	19/32
KB-320-6	KT-320-6	5/8	6	1 3/16	1	27/32	5/8
-	KT-320-9	5/8	9	1 3/16	1	27/32	5/8
-	KT-320-12	5/8	12	1 3/16	1	27/32	5/8
KB-321-6	-	11/16	6	1 1/4	1	1	11/16
KB-322-3	-	3/4	3	1 1/4	1 1/8	1 1/8	11/16
KB-322-6	KT-322-6	3/4	6	1 1/4	1 1/8	1 1/8	11/16
-	KT-322-9	3/4	9	1 1/4	1 1/8	1 1/8	11/16

Metric 6 Point, Standard & Tension Type – Extension

Part Number Standard	Part Number Tension	Hex Opening mm	Shank Length (A) mm	Socket Length (B) mm	Socket Diameter (C) mm	Nose End Diameter (D) mm	Clearance Depth (E) mm
KB-6-10m-6	KT-6-10m-6	10	152	20.6	19.1	15.1	9.5
-	KT-6-10m-9	10	229	20.6	19.1	15.1	9.5
-	KT-6-10m-12	10	305	20.6	19.1	15.1	9.5
KB-7-11m-6	-	11	152	23.8	22.2	15.9	10.3
KB-7-13m-3	-	13	76	25.4	22.2	17.5	11.9
KB-7-13m-6	KT-7-13m-6	13	152	25.4	22.2	17.5	11.9
KB-7-13m-9	KT-7-13m-9	13	229	25.4	22.2	17.5	11.9
KB-7-13m-12	-	13	305	25.4	22.2	17.5	11.9
KB-7-14m-6	KT-7-14m-6	14	152	27.0	22.2	19.1	13.5
-	KT-7-14m-12	14	305	27.0	22.2	19.1	14.3
-	KT-7-15m-6	15	152	27.0	22.2	19.1	14.3
KB-8-15m-6	KT-8-15m-6	15	152	28.6	25.4	19.8	14.3
KB-8-15m-9	KT-8-15m-9	15	229	28.6	25.4	19.8	14.3
KB-8-15m-12	KT-8-15m-12	15	305	28.6	25.4	19.8	14.3
KB-8-16m-6	KT-8-16m-6	16	152	30.2	25.4	21.4	15.9
KB-8-16m-9	KT-8-16m-9	16	229	30.2	25.4	21.4	15.9
-	KT-8-16m-12	16	305	30.2	25.4	21.4	15.9
-	KT-8-17m-6	17	152	31.8	25.4	25.4	17.5
KB-8-17m-12	KT-8-17m-12	17	305	31.8	25.4	25.4	17.5
KB-8-18m-6	KT-8-18m-6	18	152	31.8	25.4	25.4	17.5
-	KT-8-18m-9	18	229	31.8	25.4	25.4	17.5
-	KT-8-18m-12	18	305	31.8	25.4	25.4	17.5
KB-10-19m-6	KT-10-19m-6	19	152	34.9	31.8	26.2	16.3

Actual design of universal wrenches may not be exactly like pictures above.

APEX® Solutions



When can I use a universal adapter?

A universal adapter gives all of your sockets the versatility of a universal wrench. Universal adapters must not be used with impact drivers.

(See page 39.)

Does Apex offer Torx® sockets?

Like Torx® screws, Torx® bolts are becoming commonplace in a variety of



assembly applications. Apex offers a wide variety of Torx® sockets. (See page 39.)

Does Apex offer universal wrenches with longer sockets?

Universal wrenches are available with a longer socket to allow a stud to recess into the socket opening.

(Check with your Apex representative for details.)

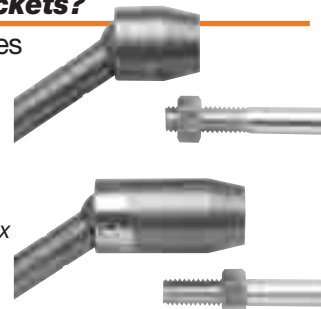

Does Apex offer bolt clearance nutsetters?

Bolt clearance nutsetters allow the bolt or stud to recess into the nutsetter body as the nut is driven down. Bolt clearance nutsetters are prefixed with the numbers 6B-.

(See page 28.)

What is the advantage of surface drive sockets?

Use surface drive sockets if tools are still running when they engage the fasteners (such as on this multi-spindle machine). They're easier to engage and will result in less tool wear.



If the tool you need does not appear in this catalog, give us a call. The odds are, we may have what you need as a non-catalog item. If not, our experienced staff of tooling experts can design and manufacture "specials" to meet the needs of your specific application. Give us a call at 1-800-845-5629 or visit our website www.apex-tools.com.

What is the benefit of a tension sleeve?

A universal wrench with a tension sleeve holds the socket at the desired driving angle while aligning the tool and fastener. Other universal wrench sockets can "flop" making engagement difficult.

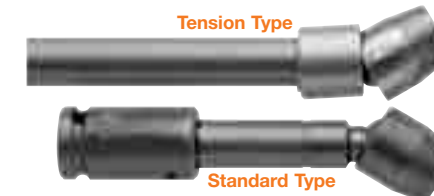

What types of magnetic sockets does Apex offer?

In addition to a fixed magnet socket (center), Apex offers spring-loaded (left) and cylindrical (right) magnet styles that allow the bolt to recess into the socket body as the nut is driven down. Fixed magnet sockets are designated by a M- part number prefix, spring-loaded by MB- prefix and cylindrical by a SM- prefix.



Does Apex offer thin wall sockets?

Thin wall sockets accommodate countersunk or limited clearance nut or bolt locations. Many of these sockets have a shouldered body design that can fit in tight quarters.



Does Apex offer a complete line of extensions?

Apex features a wide selection of extension lengths, styles and sizes.

(See the Table of Contents for a complete listing.)

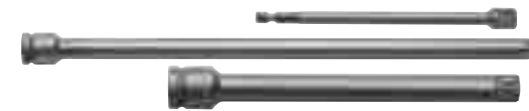

Can I use my extensions, adapters and universals with impact drivers?

Quality design and construction give Apex universal wrenches a long service life and durability. Remember, universal wrenches, extensions and adapters are not to be used with impact drivers.



Does Apex offer mar resistant bits and sockets?

Apex can nylon coat just about any of our bits or sockets. Nylon offers excellent mar resistance for assemblies that have painted, varnished or chromed surfaces. Nylon also offers some safety benefits by covering tool junctions.

(See pages 68-72 for more information)



In this section...



Impact Sockets

Apex industrial grade impact sockets are available in a wide range of lengths and wall thicknesses, and with single or double hex openings. Square openings are available in select sizes.

Fixed Magnetic Impact Sockets

Magnetic sockets hold the fastener in driving position, even when working straight down. Time-wasting motions are eliminated when starting fasteners or working in hard-to-reach areas. These sockets are identified with a M- prefix.

Magnetic Bolt Clearance Impact Sockets

As the nut is run down, a spring-loaded or hollow cylinder magnet allows the bolt or stud to retract into the socket body. Nuts are held firmly in the socket. These sockets are identified with a MB- prefix.

Surface Drive Sockets

Large openings on the six corners of the opening create a "floating" action that allows the socket to slip quickly and easily onto the nut or bolt. Ideal for compensating for imperfect alignment between the tool and fastener. Not generally recommended for impact use. These sockets are identified with a SF- prefix.

Fast Lead Impact Sockets

Designed for power tool and multiple spindle power tools, a specially tapered opening provides complete engagement with the nut almost instantly upon engagement. This speeds productivity and extends tool life. Engagement is possible without starting and stopping the tool for each nut. These sockets are identified with a FL- prefix.

Special Sockets

You'll find Spline, Torx®, tap holding, Budd Wheel, grease fitting and other sockets for special applications.

Extensions and Adapters

Apex provides the accessories needed to adapt sockets to nearly every tool and application.

Square Drive Universal Wrenches

Hard-to-reach areas are no problem with Apex's wide range of universal and extension universal wrenches.

1/4" Square Drive Sockets, SAE

Standard Length, 6 Point and Double Hex

Part Number 6 Point	Part Number Double Hex	Hex Opening In.	Overall Length (A)	Diameter Nose End (B)	Diameter Drive End (C)	Opening Depth (D)
1105	-	5/32	7/8	1/4	1/2	3/32
1106	1106-D	3/16	7/8	5/16	1/2	3/32
1107	1107-D	7/32	7/8	3/8	1/2	5/32
1108	1108-D	1/4	7/8	3/8	1/2	5/32
X-1108*	-	1/4	7/8	3/8	1/2	5/32
1109	1109-D	9/32	1	7/16	1/2	3/16
1110	1110-D	5/16	1	1/2	1/2	3/16
X-1110*	-	5/16	1	1/2	1/2	3/16
HA-510	-	5/16	7/8	7/16	7/16	3/16
1111	1111-D	11/32	1	9/16	9/16	3/16
1112	1112-D	3/8	1	9/16	9/16	1/4
1113	-	13/32	1	5/8	5/8	1/4
1114	1114-D	7/16	1	5/8	5/8	9/32
1116	1116-D	1/2	1	11/16	11/16	11/32
1118	-	9/16	1	13/16	13/16	7/16
1120	-	5/8	1	7/8	7/8	7/16

* Parts have a harder heat treat.

Long Length, 6 Point and Double Hex

Part Number 6 Point	Part Number Double Hex	Hex Opening In.	Overall Length (A)	Diameter Nose End (B)	Diameter Drive End (C)	Opening Depth (D)
1206	1206-D	3/16	1 3/4	5/16	1/2	3/32
1207	-	7/32	1 3/4	3/8	1/2	5/32
1208	1208-D	1/4	1 3/4	3/8	1/2	5/32
1209	1209-D	9/32	1 3/4	7/16	1/2	3/16
1210	1210-D	5/16	1 3/4	1/2	1/2	3/16
1211	-	11/32	1 3/4	9/16	9/16	3/16
1212	1212-D	3/8	1 3/4	9/16	9/16	1/4
1213	-	13/32	1 3/4	5/8	5/8	1/4
1214	-	7/16	1 3/4	5/8	5/8	9/32
1216	1216-D	1/2	1 3/4	11/16	11/16	11/32
1218	-	9/16	1 3/4	13/16	13/16	7/16

Extra Long Length, 6 Point and Double Hex

Part Number 6 Point	Part Number Double Hex	Hex Opening In.	Overall Length (A)	Diameter Nose End (B)	Diameter Drive End (C)	Opening Depth (D)
1308	1308-D	1/4	3	3/8	1/2	5/32
1310	-	5/16	3	1/2	1/2	3/16
1311	1311-D	11/32	3	1/2	1/2	3/16
1312	-	3/8	3	9/16	9/16	1/4
1313	-	13/32	3	9/16	9/16	1/4
1314	-	7/16	3	5/8	5/8	9/32
1316	-	1/2	3	11/16	11/16	11/32
1318	-	9/16	3	13/16	13/16	7/16
1320	-	5/8	3	7/8	7/8	7/16

Magnetic, Standard Length, 6 Point

Part Number 6 Point	Hex Opening In.	Overall Length (A)	Diameter Nose End (B)	Diameter Drive End (C)	Opening Depth (D)
M-1105	5/32	7/8	5/16	1/2	3/32
M-1106	3/16	7/8	5/16	1/2	3/32
M-1107	7/32	7/8	3/8	1/2	5/32
MX-1108*	1/4	7/8	3/8	1/2	5/32
M-1108-E*	1/4	7/8	3/8	1/2	5/32
MX-1109*	9/32	1	7/16	1/2	3/16
MHA-510	5/16	7/8	7/16	7/16	1/8
M-1110	5/16	1	1/2	1/2	3/16
MX-1110*	5/16	1	1/2	1/2	3/16
MX-1111	11/32	1	1/2	1/2	3/16
M-1112	3/8	1	9/16	9/16	1/4
MX-1112*	3/8	1	9/16	9/16	1/4
M-1114	7/16	1	5/8	5/8	9/32
M-1116	1/2	1	11/16	11/16	11/32
M-1118	9/16	1	11/16	11/16	11/32

*Parts have a harder heat treat; MX-1108-E has no lead-in chamfer.

Magnetic, Long & Extra Long, 6 Point

Part No. Fixed Magnet	Part No. Bolt Clearance	Hex Opening In.	Overall Length (A)	Diameter Nose End (B)	Diameter Drive End (C)	Opening Depth (D)
-	MB-1206	3/16	1 3/4	5/16	1/2	5/32
M-1208	MB-1208	1/4	1 3/4	3/8	1/2	5/32
-	MB-1308	1/4	3	3/8	1/2	5/32
M-1209	MB-1209	9/32	1 3/4	7/16	1/2	3/16
M-1210	MB-1210	5/16	1 3/4	1/2	1/2	3/16
-	MB-1211	11/32	1 3/4	9/16	9/16	3/16
-	MB-1311	11/32	3	1/2	1/2	3/16
M-1212	MB-1212	3/8	1 3/4	9/16	9/16	1/4
-	MB-1312	3/8	3	9/16	9/16	1/4
M-1214	MB-1214	7/16	1 3/4	5/8	5/8	9/32
-	MB-1314	7/16	3	5/8	5/8	9/32
-	MB-1216	1/2	1 3/4	11/16	11/16	11/32
-	MB-1218	9/16	1 3/4	13/16	13/16	7/16

* For explanation of magnets, see Tool Tip on page 33.

Surface Drive & Fast Lead, Standard & Long Length

Part No. Surface Drive	Part No. Fast Lead	Hex Opening In.	Overall Length (A)	Diameter Nose End (B)	Diameter Drive End (C)	Opening Depth (D)
-	FL-1108	1/4	7/8	3/8	1/2	5/32
-	FL-1109	9/32	7/8	3/8	1/2	5/32
-	FL-1110	5/16	1	1/2	1/2	3/16
SF-1112	FL-1112	3/8	1	9/16	9/16	1/4
-	FL-1212	3/8	1 3/4	9/16	9/16	1/4
-	FL-1114	7/16	1	5/8	5/8	9/32
-	FL-1214	7/16	1 3/4	5/8	5/8	9/32
SF-1116	FL-1116	1/2	1	11/16	11/16	11/32
-	FL-1216	1/2	1 3/4	11/16	11/16	11/32

1/4" Sq. Dr. Sockets For SAE Sheet Metal Screws

6 Point & 6 Point Magnetic, For Predrilled Holes*



Part Number 6 Point	Part Number Magnetic	Hex Opening In.	Overall Length (A)	Diameter Nose End (B)	Diameter Drive End (C)	Opening Depth (D)
-	M1E06	3/16	7/8	5/16	1/2	3/32
-	M1E07	7/32	7/8	3/8	1/2	5/32
1E08	M1E08	1/4	7/8	3/8	1/2	5/32
1E10	M1E10	5/16	7/8	1/2	1/2	3/16
-	M1E11	11/32	1	1/2	1/2	3/16
-	M1E12	3/8	1	5/8	5/8	1/4
-	M1E14	7/16	1	11/16	11/16	9/32
-	M1E16	1/2	1	11/16	11/16	11/32

*Sockets for predrilled holes are intermediate hardness; sockets for self-drilling and tapping screws are maximum hardness.

6 Point & 6 Point Magnetic, for Self-Drilling and Tapping Screws*



Part Number 6 Point	Part Number Magnetic	Hex Opening In.	Overall Length (A)	Diameter Nose End (B)	Diameter Drive End (C)	Opening Depth (D)
1P06	M1P06	3/16	7/8	5/16	1/2	3/32
1P07	M1P07	7/32	7/8	3/8	1/2	5/32
1P08	M1P08	1/4	7/8	7/16	1/2	5/32
-	M1P09	9/32	7/8	1/2	1/2	3/16
1P10	M1P10	5/16	7/8	1/2	1/2	3/16
1P11	M1P11	11/32	1	1/2	1/2	3/16
1P12	M1P12	3/8	1	5/8	5/8	1/4
1P14	M1P14	7/16	1	11/16	11/16	9/32
1P16	M1P16	1/2	1	11/16	11/16	11/32

*Sockets for predrilled holes are intermediate hardness; sockets for self-drilling and tapping screws are maximum hardness.

1/4" Sq. Dr. Sockets For SAE Square Nuts

Single Square & Double Square



Part Number Square	Part No. Double Square	Hex Opening In.	Overall Length (A)	Diameter Nose End (B)	Diameter Drive End (C)	Opening Depth (D)
1608	1608-D	1/4	1	1/2	1/2	3/16
1612	1612-D	3/8	1	3/4	3/4	1/4

1/4" Square Drive Universal Wrenches, SAE

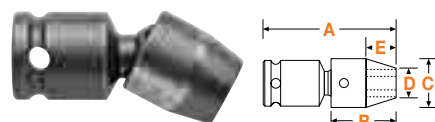

6 Point and Double Hex

Part Number 6 Point	Part Number Double Hex	Hex Opening In.	Overall Length (A)	Socket Length (B)	Socket Diameter (C)	Nose End Diameter (D)	Clearance Depth (E)
SA-25	SA-25-D	1/4	1 7/32	3/4	5/8	3/8	3/8
SA-26	SA-26-D	5/16	1 17/32	3/4	5/8	7/16	3/8
SA-28	SA-28-D	3/8	1 19/32	13/16	5/8	17/32	7/16
SA-29	SA-29-D	7/16	1 21/32	7/8	5/8	5/8	1/2
SA-30	SA-30-D	1/2	1 21/32	7/8	11/16	11/16	1/2
SA-65	-	9/16	1 21/32	7/8	11/16	11/16	1/2

Universal wrenches must not be used with impact drivers. Maximum operating angle is 30°.

1/4" Square Drive Sockets, Metric

Standard Length, 6 Point and Double Hex

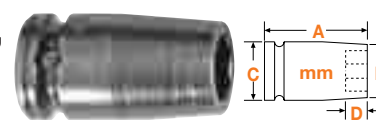

Part Number 6 Point	Part Number Double Hex	Hex Opening mm	Overall Length (A)	Diameter Nose End (B)	Diameter Drive End (C)	Opening Depth (D)
3.5mm11	-	3.5	22.2	6.4	12.7	2.4
4mm11	-	4	22.2	6.4	12.7	2.4
4.5mm11	-	4.5	22.2	7.9	12.7	2.4
5mm11	-	5	22.2	8.7	12.7	3.9
5.5mm11	-	5.5	22.2	9.5	12.7	3.9
6mm11	6mm11-D	6	22.2	9.5	12.7	3.9
7mm11	7mm11-D	7	22.2	11.1	12.7	4.8
8mm11	8mm11-D	8	25.4	12.7	12.7	4.8
9mm11	9mm11-D	9	25.4	14.3	14.3	4.8
10mm11	10mm11-D	10	25.4	15.9	15.9	6.4
OS-10mm11	-	10	25.4	14.3	14.3	6.4
11mm11	11mm11-D	11	25.4	15.9	15.9	7.2
12mm11	12mm11-D	12	25.4	17.5	17.5	7.2
13mm11	13mm11-D	13	25.4	19.1	19.1	8.7
14mm11	14mm11-D	14	25.4	20.6	20.6	11.1
15mm11	-	15	25.4	22.2	22.2	11.1
16mm11	-	16	25.4	22.2	22.2	11.1

Long Length, 6 Point and Double Hex



Part Number 6 Point	Part Number Double Hex	Hex Opening mm	Overall Length (A)	Diameter Nose End (B)	Diameter Drive End (C)	Opening Depth (D)
5mm21	-	5	44.4	8.7	12.7	3.9
5.5mm21	-	5.5	44.4	9.5	12.7	3.9
6mm21	-	6	44.4	9.5	12.7	3.9
7mm21	-	7	44.4	11.1	12.7	4.8
8mm21	8mm21-D	8	44.4	12.7	12.7	4.8
9mm21	9mm21-D	9	44.4	14.3	14.3	4.8
10mm21	10mm21-D	10	44.4	15.9	15.9	6.4
11mm21	-	11	44.4	15.9	15.9	7.2
12mm21	-	12	44.4	17.5	17.5	7.2
13mm21	13mm21-D	13	44.4	19.1	19.1	8.7
14mm21	-	14	44.4	20.6	20.6	11.1
15mm21	15mm21-D	15	50.8	22.2	22.2	11.1
16mm21	-	16	50.8	22.2	22.2	11.1

Magnetic, Standard Length, 6 Point



Part Number Fixed Magnet	Hex Opening mm	Overall Length (A)	Diameter Nose End (B)	Diameter Drive End (C)	Opening Depth (D)
M-5mm11	5	22.2	8.7	12.7	3.9
M-5.5mm11	5.5	22.2	9.5	12.7	3.9
M-6mm11	6	22.2	9.5	12.7	3.9
M-7mm11	7	22.2	11.9	12.7	4.8
M-8mm11	8	25.4	12.7	12.7	4.8
M-9mm11	9	25.4	14.3	14.3	4.8
M-10mm11	10	25.4	15.9	15.9	6.4
M-11mm11	11	25.4	15.9	15.9	7.2
M-12mm11	12	25.4	17.5	17.5	7.2
M-13mm11	13	25.4	19.1	19.1	8.7
M-14mm11	14	25.4	20.6	20.6	11.1
M-15mm11	15	25.4	22.2	22.2	11.1

Magnetic, Long Length, 6 Point



Part No. Fixed Magnet	Part No. Magnetic Bolt Clearance	Hex Opening mm	Overall Length (A)	Diameter Nose End (B)	Diameter Drive End (C)	Opening Depth (D)
-	MB-5mm21	5	44.4	8.7	12.7	3.9
-	MB-5.5mm21	5.5	44.4	9.5	12.7	3.9
M-6mm21	MB-6mm21	6	44.4	9.5	12.7	3.9
M-7mm21	MB-7mm21	7	44.4	11.9	12.7	4.8
M-8mm21	MB-8mm21	8	44.4	12.7	12.7	4.8
M-9mm21	MB-9mm21	9	44.4	14.3	14.3	4.8
M-10mm21	MB-10mm21	10	44.4	15.9	15.9	6.4
-	**OSMB-10mm21	10	44.4	14.2	14.2	6.4
M-11mm21	MB-11mm21	11	44.4	15.9	15.9	7.2
M-12mm21	MB-12mm21	12	44.4	17.5	17.5	7.2
M-13mm21	MB-13mm21	13	44.4	19.1	19.1	8.7
-	MB-14mm21	14	44.4	20.6	20.6	11.1
-	MB-15mm21	15	50.8	22.2	22.2	11.1
-	MB-16mm21	16	50.8	22.2	22.2	11.1

*For an explanation of magnets, see Tool Tip on page 33.
** No ring groove.

Surface Drive, Standard and Long Length



Part Number Surface Drive	Hex Opening mm	Overall Length (A)	Diameter Nose End (B)	Diameter Drive End (C)	Opening Depth (D)
SF-8mm11	8	25.4	12.7	12.7	4.7
SF-10mm11	10	25.4	15.9	15.9	6.4
SF-10mm21	10	44.4	15.9	15.9	6.4
SF-12mm21	11	44.4	17.5	15.9	7.2
SF-13mm11	13	25.4	19.1	19.1	8.7
SF-13mm21	13	44.4	19.1	19.1	8.7
SF-15mm11	15	25.4	22.2	22.2	11.1

1/4" Sq. Dr. Sockets For Metric Sheet Metal Screws

6 Point and 6 Point Magnetic



Part Number 6 Point	Part Number Magnetic	Hex Opening mm	Overall Length (A)	Diameter Nose End (B)	Diameter Drive End (C)	Opening Depth (D)
3.5mmE1	-	3.5	22.2	6.4	12.7	2.4
4mmE1	M-4mmE1	4	22.2	6.4	12.7	2.4
-	M-5mmE1	5	22.2	8.7	12.7	3.9
5.5mmE1	M-5.5mmE1	5.5	22.2	9.5	12.7	3.9
6mmE1	M-6mmE1	6	22.2	9.5	12.7	3.9
7mmE1	M-7mmE1	7	22.2	11.1	12.7	4.8
-	MR-7mmE1*	7	22.2	11.1	12.7	4.8
8mmE1	M-8mmE1	8	25.4	12.7	12.7	4.8
9mmE1	M-9mmE1	9	25.4	14.3	14.3	4.8
10mmE1	M-10mmE1	10	25.4	15.9	15.9	6.4
11mmE1	M-11mmE1	11	25.4	17.5	17.5	7.2
12mmE1	M-12mmE1	12	25.4	17.5	17.5	7.2
13mmE1	M-13mmE1	13	25.4	19.1	19.1	8.7

*MR-7mmE1 has stronger magnet

1/4" Sq. Dr. Universal Wrenches, Metric

6 Point

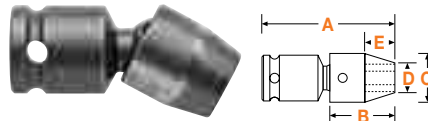

Part Number 6 Point	Hex Opening mm	Overall Length (A)	Socket Length (B)	Socket Diameter (C)	Nose End Diameter (D)	Opening Depth (E)
SA-15-6M	6	31	19.1	15.9	9.5	9.5
SA-15-7M	7	31	19.1	15.9	10.3	9.5
SA-16-8M	8	38	19.1	19.1	11.1	7.9
SA-16-10M	10	40	20.6	19.1	15.1	9.5

Universal wrenches must not be used with impact drivers. Maximum operating angle is 30°.

If the tool you need does not appear in this catalog, give us a call. The odds are, we may have what you need as a non-catalog item. If not, our experienced staff of tooling experts can design and manufacture "specials" to meet the needs of your specific application. Give us a call at 1-800-845-5629 or visit our website www.apex-tools.com.

1/4" Sq. Dr. Sockets For Spline Fasteners

Standard and Long Length

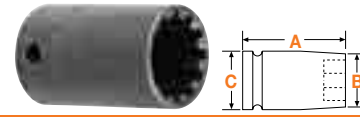

Part Number	Spline Size	Nominal Size	Overall Length (A) In. mm	Diameter Nose End (B) In. mm	Diameter Drive End (C) In. mm
CMS-1507	7	7/32	2 51	21/64 8	7/16 11
CMS-1408	8	1/4	7/8 22	3/8 10	7/16 11
CMS-1508	8	1/4	2 51	3/8 10	7/16 11
CMS-1409	9	9/32	7/8 22	7/16 11	7/16 11
CMS-1509	9	9/32	2 51	7/16 11	7/16 11
CMS-1410	10	5/16	7/8 22	29/64 12	29/64 12
CMS-1510	10	5/16	2 51	29/64 12	29/64 12
CMS-1412	12	3/8	7/8 22	17/32 14	17/32 14
CMS-1414	14	7/16	1 25	39/64 16	39/64 16

Apex spline sockets conform to military specifications MS-37787 and MIL-W-8982C.

1/4" Sq. Dr. Torx® Sockets

For External Torx Screws



Part Number	Driver Size	Overall Length (A) In. mm	Nose End Diameter (B) In. mm	Drive End Diameter (C) In. mm
TX-1104	E-4	1 25.4	1/4 6.4	1/2 12.7
TX-1105	E-5	1 25.4	1/4 6.4	1/2 12.7
TX-1106	E-6	1 25.4	5/16 7.9	1/2 12.7
TX-1108	E-8	1 25.4	3/8 9.5	1/2 12.7
TX-1110	E-10	1 25.4	9/16 14.3	9/16 14.3
TX-1112	E-12	1 25.4	5/8 15.9	5/8 15.9

For External Torx Screws, Thin Wall



Part Number	Driver Size	Overall Length (A) In. mm	Nose End Diameter (B) In. mm	Drive End Diameter (C) In. mm
TX-1404	E-4	1 25.4	1/4 6.4	1/2 12.7
TX-1405	E-5	1 25.4	1/4 6.4	1/2 12.7
TX-1406	E-6	1 25.4	5/16 7.9	1/2 12.7
TX-1407	E-7	1 25.4	5/16 7.9	1/2 12.7
TX-1408	E-8	1 25.4	3/8 9.5	1/2 12.7
TX-1410	E-10	1 25.4	1/2 12.7	1/2 12.7
TX-1411	E-11	1 25.4	1/2 12.7	1/2 12.7
TX-1412	E-12	1 25.4	9/16 14.3	9/16 14.3

For Torx Nuts



Part Number	Driver Size	Overall Length (A) In. mm	Nose End Diameter (B) In. mm	Drive End Diameter (C) In. mm
TX-1E05	E-5	7/8 22.2	3/8 9.5	1/2 12.7
TX-1E06	E-6	7/8 22.2	7/16 11.1	1/2 12.7
TX-1E08	E-8	7/8 22.2	1/2 12.7	1/2 12.7

Sockets for Torx® nuts have a larger lead-in chamfer than sockets for external Torx® screws. Most Torx® sockets have a DIN (pin and o-ring) groove.

1/4" Sq. Dr. Extensions

7/8" to 14" (22mm to 356mm) Length



Part Number	Male Square In.	Type of Lock	Overall Length In.	Overall Length mm
EX-252	1/4	Pin	7/8	22
EX-252-B	1/4	Ball	1	25
EX-255-2	1/4	Pin	2	51
EX-255-B-2	1/4	Ball	2	51
EX-255-3	1/4	Pin	3	76
EX-255-4	1/4	Pin	4	102
EX-255-B-4	1/4	Ball	4	102
EX-255-6	1/4	Pin	6	152
EX-255-B-6	1/4	Ball	6	152
EX-255-8	1/4	Pin	8	203
EX-255-10	1/4	Pin	10	254
EX-255-12	1/4	Pin	12	305
EX-255-14	1/4	Pin	14	356

1/4" Sq. Dr. Adapters

1/4" to 3/8" Male Square



Part Number	Male Square In.	Female Square In.	Type of Lock	Overall Length In.	Overall Length mm
EX-372	3/8	1/4	Pin	1	25
EX-372-B	3/8	1/4	Ball	1	25

1/4" Sq. Dr. Universal Adapters

Male Square to Female Square



Part Number	Male Sq. In.	Female Sq. In.	Type of Lock	Overall Length In.	Overall Length mm	Largest Diameter In.	Largest Diameter mm
MF-25	1/4	1/4	Pin	1 5/8	41	5/8	16
MF-25-B	1/4	1/4	Ball	1 5/8	41	5/8	16

Universal wrenches must not be used with impact drivers. Maximum operating angle is 30°.

3/8" Square Drive Sockets, SAE

6 Point & Double Hex, Short and Standard Length

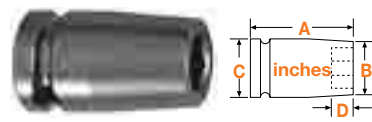

Part Number 6 Point	Part Number Double Hex	Hex Opening In.	Overall Length (A)	Diameter Nose End (B)	Diameter Drive End (C)	Opening Depth (D)
3108	3108-D	1/4	1 1/4	7/16	3/4	5/32
3109	-	9/32	1 1/4	7/16	3/4	3/16
3010	-	5/16	7/8	1/2	3/4	3/16
3110	3110-D	5/16	1 1/4	1/2	3/4	3/16
3111	-	11/32	1 1/4	1/2	3/4	3/16
3012	3012-D	3/8	7/8	19/32	3/4	3/16
3112	3112-D	3/8	1 1/4	19/32	3/4	1/4
3113	3113-D	13/32	1 1/2	11/16	3/4	1/4
3014	3014-D	7/16	7/8	11/16	3/4	9/32
3114	3114-D	7/16	1 1/2	11/16	3/4	9/32
SW-604	-	7/16	1 1/2	21/32	3/4	9/32
3016	3016-D	1/2	7/8	13/16	13/16	5/16
3116	3116-D	1/2	1 1/2	13/16	13/16	11/32
HC-3816	-	1/2	1 1/2	11/16	11/16	11/32
3117	-	17/32	1 1/2	13/16	13/16	11/32
3018	3018-D	9/16	7/8	7/8	7/8	5/16
3118	-	9/16	1 1/2	7/8	7/8	7/16
SW-343	-	9/16	1 1/2	3/4	3/4	7/16
SW-605	SW-605-D	9/16	1 1/2	3/4	13/16	7/16
3119	-	19/32	1 1/2	7/8	7/8	7/16
3020	3020-D	5/8	1	15/16	15/16	7/16
3120	3120-D	5/8	1 1/2	15/16	15/16	7/16
HC-3520*	-	5/8	2 3/8	7/8	7/8	7/32
3022	3022-D	11/16	1	1	1	7/16
3122	-	11/16	1 1/2	1	1	7/16
3024	3024-D	3/4	1	1 1/16	1 1/16	7/16
3124	3124-D	3/4	1 1/2	1 1/16	1 1/16	15/32
3126	-	13/16	1 1/2	1 1/8	1 1/8	7/16
3028	3028-D	7/8	1	1 1/4	1 1/4	7/16

*HC-3520 is spark plug socket.

6 Point & Double Hex, Thin Wall, Standard Length



Part Number 6 Point	Part Number Double Hex	Hex Opening In.	Overall Length (A)	Diameter Nose End (B)	Diameter Drive End (C)	Opening Depth (D)
3408	3408-D	1/4	1 1/4	7/16	3/4	5/32
3409	-	9/32	1 1/4	7/16	3/4	3/16
3410	3410-D	5/16	1 1/4	1/2	3/4	3/16
OS-3410*	-	5/16	1 1/4	7/16	19/32	3/16
3412	3412-D	3/8	1 1/2	19/32	3/4	1/4
3414	3414-D	7/16	1 1/2	5/8	3/4	9/32
3416	3416-D	1/2	1 1/2	3/4	3/4	11/32
3418	3418-D	9/16	1 1/2	25/32	13/16	7/16
3420	3420-D	5/8	1 1/2	7/8	7/8	7/16
3424	3424-D	3/4	1 1/2	1	1	15/32
3426	-	13/16	1 1/2	1 1/8	1 1/8	17/32
3428	-	7/8	1 1/2	1 3/16	1 1/4	9/16
3430	3430-D	15/16	1 1/2	1 5/16	1 5/16	5/8
3432	-	1	1 1/2	1 3/8	1 3/8	5/8
3434	-	1 1/16	1 1/2	1 1/2	1 1/2	11/16

*No ring groove.

6 Point & Double Hex, Long and Extra Long



Part Number 6 Point	Part Number Double Hex	Hex Opening In.	Overall Length (A)	Diameter Nose End (B)	Diameter Drive End (C)	Opening Depth (D)
3208	3208-D	1/4	2	7/16	3/4	5/32
3308	-	1/4	3 1/2	7/16	3/4	5/32
3209	-	9/32	2	7/16	3/4	3/16
3210	3210-D	5/16	2	1/2	3/4	3/16
3310	3310-D	5/16	3 1/2	1/2	3/4	3/16
OS-3310-D*	-	5/16	3 1/2	15/32	5/8	3/16
3211	-	11/32	2	1/2	3/4	3/16
3311	-	11/32	3 1/2	1/2	3/4	3/16
3212	3212-D	3/8	2	19/32	3/4	1/4
3312	3312-D	3/8	3 1/2	19/32	3/4	1/4
3214	3214-D	7/16	2	11/16	3/4	9/32
3314	3314-D	7/16	3 1/2	11/16	3/4	9/32
3216	3216-D	1/2	2	13/16	13/16	11/32
3316	3316-D	1/2	3 1/2	13/16	13/16	11/32
3218	3218-D	9/16	2	7/8	7/8	7/16
3318	3318-D	9/16	3 1/2	7/8	7/8	7/16
3220	3220-D	5/8	2	15/16	15/16	7/16
3320	3320-D	5/8	3 1/2	15/16	15/16	7/16
3222	3222-D	11/16	2	1	1	7/16
3322	3322-D	11/16	3 1/2	1	1	7/16
3224	3224-D	3/4	2	1 1/16	1 1/16	15/32
3324	3324-D	3/4	3 1/2	1 1/16	1 1/16	15/32
3226	3226-D	13/16	2	1 1/4	1 1/4	17/32
3326	3326-D	13/16	3 1/2	1 1/4	1 1/4	17/32
3228	3228-D	7/8	2	1 1/4	1 1/4	9/16
3328	-	7/8	3 1/2	1 1/4	1 1/4	9/16

*No ring groove.

6 Point & Double Hex, Thin Wall, Long Length



Part Number 6 Point	Part Number Double Hex	Hex Opening In.	Overall Length (A)	Diameter Nose End (B)	Diameter Drive End (C)	Opening Depth (D)
3510	-	5/16	2	1/2	3/4	3/16
3511	-	11/32	2	1/2	3/4	3/16
3512	3512-D	3/8	2	19/32	3/4	1/4
3514	3514-D	7/16	2	5/8	3/4	9/32
3516	3516-D	1/2	2	3/4	3/4	11/32
3518	3518-D	9/16	2	25/32	13/16	7/16
3524	3524-D	3/4	2	1	1	15/32
3530	-	15/16	2	1 5/16	1 5/16	5/8
3532	-	1	2	1 3/8	1 3/8	5/8
3534	-	1 1/16	2	1 1/2	1 1/2	11/16

3/8" Square Drive Sockets, SAE

Magnetic, Short and Standard Length



Part Number Fixed Magnet	Hex Opening In.	Overall Length (A)	Diameter Nose End (B)	Diameter Drive End (C)	Opening Depth (D)
M-3108	1/4	1 1/4	7/16	3/4	5/32
M-3109	9/32	1 1/4	7/16	3/4	3/16
M-3110	5/16	1 1/4	1/2	3/4	3/16
M-3012	3/8	7/8	19/32	3/4	3/16
M-3112	3/8	1 1/4	19/32	3/4	1/4
M-3014	7/16	7/8	11/16	3/4	9/32
M-3114	7/16	1 1/2	11/16	3/4	9/32
MSW-604	7/16	1 1/2	21/32	3/4	9/32
M-3016	1/2	7/8	13/16	13/16	5/16
M-3116	1/2	1 1/2	13/16	13/16	11/32
MHC-3816	1/2	1 1/2	11/16	11/16	11/32
M-3018	9/16	7/8	7/8	7/8	5/16
M-3118	9/16	1 1/2	7/8	7/8	7/16
MSW-343	9/16	1 1/2	3/4	3/4	7/16
M-3120	5/8	1 1/2	15/16	15/16	7/16

Magnetic, Thin Wall, Standard Length



Part Number Fixed Magnet	Hex Opening In.	Overall Length (A)	Diameter Nose End (B)	Diameter Drive End (C)	Opening Depth (D)
M-3408	1/4	1 1/4	7/16	3/4	5/32
M-3410	5/16	1 1/4	1/2	3/4	3/16
OSM-3410*	5/16	1 1/4	7/16	19/32	3/16
M-3411	11/32	1 1/4	1/2	3/4	3/16
M-3412	3/8	1 1/2	19/32	3/4	1/4
M-3414	7/16	1 1/2	5/8	3/4	9/32
OSM-3414*	7/16	1 1/2	5/8	5/8	9/32
M-3416	1/2	1 1/2	3/4	3/4	11/32
M-3418	9/16	1 1/2	25/32	13/16	7/16
M-3424	3/4	1 1/2	1	1	15/32
M-3426	13/16	1 1/2	1 1/8	1 1/8	17/32

*No ring groove.

Magnetic, Long Length & Extra Long



Part No. Fixed Magnet	Part No. Magnetic Bolt Clearance	Hex Opening In.	Overall Length (A)	Diameter Nose End (B)	Diameter Drive End (C)	Opening Depth (D)
-	MB-3210	5/16	2	1/2	3/4	3/16
M-3212	MB-3212	3/8	2	19/32	3/4	1/4
M-3214	MB-3214	7/16	2	11/16	3/4	9/32
-	MB-3314	7/16	3 1/2	11/16	3/4	9/32
M-3216	MB-3216	1/2	2	13/16	13/16	11/32
M-3218	MB-3218	9/16	2	7/8	7/8	7/16
-	MB-3318	9/16	3 1/2	7/8	7/8	7/16
-	MB-3220	5/8	2	15/16	15/16	7/16

Magnetic, Thin Wall, Long Length



Part No. Fixed Magnet	Part No. Magnetic Bolt Clearance	Hex Opening In.	Overall Length (A)	Diameter Nose End (B)	Diameter Drive End (C)	Opening Depth (D)
-	MB-3512	3/8	2	19/32	3/4	1/4
M-3514	MB-3514	7/16	2	5/8	3/4	9/32
-	MB-3516	1/2	2	3/4	3/4	11/32

Surface Drive & Fast Lead, Short and Standard Length

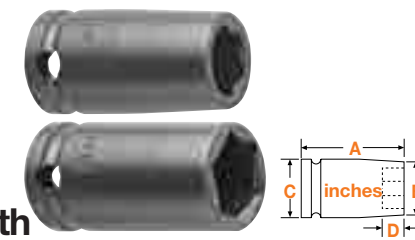

Part No. Surface Drive	Part Number Fast Lead	Hex Opening In.	Overall Length (A)	Diameter Nose End (B)	Diameter Drive End (C)	Opening Depth (D)
SF-3010	-	5/16	7/8	1/2	3/4	3/16
SF-3110	FL-3110	5/16	1 1/4	1/2	3/4	3/16
SF-3012	FL-3012	3/8	7/8	19/32	3/4	3/16
SF-3112	FL-3112	3/8	1 1/4	19/32	3/4	1/4
SF-3014	FL-3014	7/16	7/8	11/16	3/4	9/32
SF-3114	FL-3114	7/16	1 1/2	11/16	3/4	9/32
SF-3016	FL-3016	1/2	7/8	13/16	13/16	5/16
SF-3116	FL-3116	1/2	1 1/2	13/16	13/16	11/32
SF-HC-3816	-	1/2	1 1/2	11/16	11/16	11/32
SF-3018	FL-3018	9/16	7/8	7/8	7/8	5/16
SF-3118	FL-3118	9/16	1 1/2	7/8	7/8	7/16
SF-3120	FL-3120	5/8	1 1/2	15/16	15/16	7/16
-	FL-3022	11/16	1	15/16	15/16	7/16
-	FL-3122	11/16	1 1/2	1	1	7/16
-	FL-3024	3/4	1	1 1/16	1 1/16	7/16
-	FL-3124	3/4	1 1/2	1 1/16	1 1/16	15/32

Surface Drive & Fast Lead, Thin Wall, Standard Length

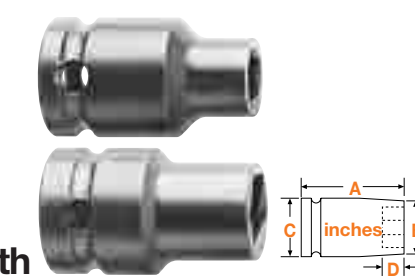

Part No. Surface Drive	Part Number Fast Lead	Hex Opening In.	Overall Length (A)	Diameter Nose End (B)	Diameter Drive End (C)	Opening Depth (D)
SF-3412	FL-3412	3/8	1 1/2	19/32	3/4	1/4
SF-3414	FL-3414	7/16	1 1/2	5/8	3/4	9/32
SF-3416	-	1/2	1 1/2	3/4	3/4	11/32
SF-3418	-	9/16	1 1/2	25/32	13/16	7/16
SF-3432	-	1	1 1/2	1 3/8	1 3/8	5/8

3/8" Sq. Dr. Sockets, SAE

Surface Drive & Fast Lead, Long and Extra Long Length

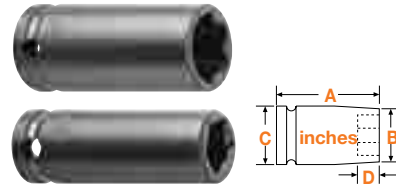

Part No. Surface Drive	Part Number Fast Lead	Hex Opening In.	Overall Length (A)	Diameter Nose End (B)	Diameter Drive End (C)	Opening Depth (D)
-	FL-3210	5/16	2	1/2	3/4	3/16
SF-3212	FL-3212	3/8	2	19/32	3/4	1/4
-	FL-3312	3/8	3 1/2	19/32	3/4	1/4
SF-3214	FL-3214	7/16	2	11/16	3/4	9/32
SF-3314	FL-3314	7/16	3 1/2	11/16	3/4	9/32
SF-3216	FL-3216	1/2	2	13/16	13/16	11/32
SF-3316	FL-3316	1/2	3 1/2	13/16	13/16	11/32
SF-3218	FL-3218	9/16	2	7/8	7/8	7/16
SF-3318	FL-3318	9/16	3 1/2	7/8	7/8	7/16
-	FL-3220	5/8	2	15/16	15/16	7/16
SF-3320	FL-3320	5/8	3 1/2	15/16	15/16	7/16
SF-3224	-	3/4	2	1 1/16	1 1/16	15/32
SF-3324	FL-3324	3/4	3 1/2	1 1/16	1 1/16	15/32
-	FL-3326	13/16	3 1/2	1 1/4	1 1/4	17/32

Surface Drive, Thin Wall, Long Length



Part No. Surface Drive	Hex Opening In.	Overall Length (A)	Diameter Nose End (B)	Diameter Drive End (C)	Opening Depth (D)
SF-3512	3/8	2	19/32	3/4	1/4
OSSF-3512*	3/8	2	19/32	19/32	1/4
SF-3514	7/16	2	5/8	3/4	9/32
OSSF-3514*	7/16	2	5/8	5/8	9/32
SF-3516	1/2	2	3/4	3/4	11/32
SF-3518	9/16	2	25/32	13/16	7/16

*No ring groove.

3/8" Sq. Dr. Sockets For SAE Sheet Metal Screws

6 Point & 6 Point Magnetic, For Predrilled Holes*



Part No. Non-Magnetic	Part No. Magnetic	Hex Opening In.	Overall Length (A)	Diameter Nose End (B)	Diameter Drive End (C)	Opening Depth (D)
-	M3E08	1/4	1 1/4	7/16	3/4	5/32
3E10	M3E10	5/16	1 1/4	1/2	3/4	3/16
3E11	-	11/32	1 1/4	1/2	3/4	3/16
3E12	M3E12	3/8	1 1/4	19/32	3/4	1/4
3E14	M3E14	7/16	1 1/4	11/16	3/4	9/32
3E16	M3E16	1/2	1 1/2	13/16	13/16	11/32
-	M3E18	9/16	1 1/2	7/8	7/8	7/16

3/8" Sq. Dr. Sockets For SAE Sheet Metal Screws

6 Point & 6 Point Magnetic, For Self-Tapping Screws*

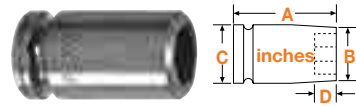

Part No. Non-Magnetic	Part No. Magnetic	Hex Opening In.	Overall Length (A)	Diameter Nose End (B)	Diameter Drive End (C)	Opening Depth (D)
-	M3P06	3/16	1 1/4	5/16	3/4	3/32
-	M3P07	7/32	1 1/4	3/8	3/4	5/32
-	M3P08	1/4	1 1/4	7/16	3/4	5/32
3P10	M3P10	5/16	1 1/4	1/2	3/4	3/16
3P12	M3P12	3/8	1 1/4	5/8	3/4	1/4
3P14	M3P14	7/16	1 1/4	11/16	3/4	9/32
3P16	M3P16	1/2	1 1/2	13/16	13/16	11/32
-	M3P18	9/16	1 1/2	7/8	7/8	7/16

*Sockets for predrilled holes are intermediate hardness; sockets for self-tapping screws are maximum hardness.

3/8" Sq. Dr. Sockets For SAE Square Nuts

Single Square & Double Square

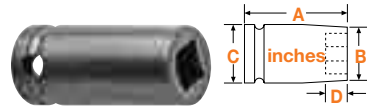

Part No. Single Square	Part No. Double Square	Hex Opening In.	Overall Length (A)	Diameter Nose End (B)	Diameter Drive End (C)	Opening Depth (D)
3607	-	7/32	1 1/2	7/16	3/4	3/16
3608	-	1/4	1 1/2	1/2	3/4	3/16
3609	3609-D	9/32	1 1/2	9/16	3/4	3/16
3610	3610-D	5/16	1 1/2	5/8	3/4	1/4
3612	3612-D	3/8	1 1/2	3/4	3/4	1/4
3614	3614-D	7/16	1 1/2	7/8	7/8	9/32
3616	3616-D	1/2	1 1/2	1	1	11/32
3618	3618-D	9/16	1 1/2	1	1	7/16
3620	-	5/8	1 1/2	1 1/8	1 1/8	7/16
3624	-	3/4	1 1/2	1 3/8	1 3/8	15/32

3/8" Sq. Dr. Socket Sets, SAE

6 Point



APS38	8 piece, standard length: 5/16, 3/8, 7/16, 1/2, 9/16, 5/8, 11/16, 3/4
APS38L	8 piece, long length: 5/16, 3/8, 7/16, 1/2, 9/16, 5/8, 11/16, 3/4

3/8" Sq. Dr. Universal Wrenches, SAE

6 Point & 12 Point

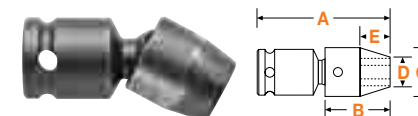

Part Number 6 Point	Part Number 12 Point	Hex Opening In.	Overall Length (A) In.	Socket Length (B) In.	Socket Diameter (C) In.	Nose End Diameter (D) In.	Clearance Depth (E) In.
SA-120	SA-120-D	5/16	1 53/64	3/4	3/4	7/16	5/16
SA-122	SA-122-D	3/8	1 57/64	13/16	3/4	9/16	3/8
SA-200	-	3/8	1 15/16	7/8	7/8	9/16	11/32
SA-123	SA-123-D	7/16	2 1/64	15/16	3/4	19/32	1/2
SA-201	-	7/16	2	15/16	7/8	5/8	13/32
SA-124	SA-124-D	1/2	2 5/64	1	3/4	3/4	9/16
SA-202	SA-202-D	1/2	2 1/16	1	7/8	11/16	15/32
SA-125	SA-125-D	9/16	2 1/8	1	13/16	13/16	9/16
SA-203	SA-203-D	9/16	2 1/16	1 1/16	7/8	3/4	17/32
SA-302	-	9/16	2 1/8	1 1/8	1	3/4	9/16
SA-205	SA-205-D	5/8	2 1/8	1 1/8	7/8	7/8	19/32
SA-305	-	11/16	2 5/16	1 1/4	1	1	11/16
SA-306	-	3/4	2 5/16	1 1/4	1 1/8	1 1/8	11/16

Universal wrenches must not be used with impact drivers. Maximum operating angle is 30°.

3/8" Sq. Dr. IronBand™ Universal Wrenches, SAE

6 Point

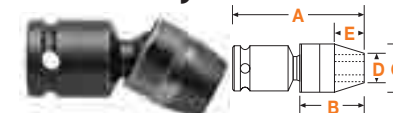

Part Number	Hex Opening In.	Overall Length (A) In.	Socket Length (B) In.	Socket Diameter (C) In.	Nose End Diameter (D) In.	Clearance Depth (E) In.
SA-C-120	5/16	1.83	.75	.75	.44	.31
SA-C-122	3/8	1.89	.81	.75	.56	.38
SA-C-123	7/16	2.02	.94	.75	.59	.50
SA-C-124	1/2	2.08	1.0	.75	.75	.56
SA-C-205	5/8	2.13	1.13	.88	.88	.59
SA-C-305	11/16	2.31	1.25	1.00	1.00	.69
SA-C-306	3/4	2.31	1.25	1.13	1.13	.69

Universal wrenches must not be used with impact drivers. Maximum operating angle is 30°.

3/8" Sq. Dr. Universal Wrench Set, SAE

6 Point



APU37	7 piece, standard length: 3/8, 7/16, 1/2, 9/16, 5/8, 11/16, 3/4
-------	--

3/8" Sq. Dr. Universal Wrenches, SAE - Extension

6 Point Standard and Tension Type



Part Number Standard	Part Number Tension	Hex Opening In.	Overall Length (A) In.	Socket Length (B) In.	Socket Dia. (C) In.	Nose End Dia. (D) In.	Clearance Depth (E) In.
KA-43-6	KD-43-6	3/8	6	13/16	5/8	17/32	7/16
KA-44-3	-	7/16	3	7/8	5/8	5/8	1/2
KA-44-4	-	7/16	4	7/8	5/8	5/8	1/2
KA-44-6	KD-44-6	7/16	6	7/8	5/8	5/8	1/2
KA-103-6	KD-103-6	7/16	6	15/16	3/4	19/32	1/2
KA-45-3	-	1/2	3	7/8	11/16	11/16	1/2
KA-45-4	-	1/2	4	7/8	11/16	11/16	1/2
KA-45-6	KD-45-6	1/2	6	7/8	11/16	11/16	1/2
KA-45-9	-	1/2	9	7/8	11/16	11/16	1/2
KA-104-9	-	1/2	9	1	3/4	3/4	9/16
-	KD-104-12	1/2	12	1	3/4	3/4	9/16
KA-105-3	KD-105-3	9/16	3	1	13/16	13/16	9/16
KA-105-4	-	9/16	4	1	13/16	13/16	9/16
KA-105-6	KD-105-6	9/16	6	1	13/16	13/16	9/16
KA-105-9	-	9/16	9	1	13/16	13/16	9/16
KA-205-3	-	5/8	3	1 1/8	7/8	7/8	19/32
-	KD-205-6	5/8	6	1 1/8	7/8	7/8	19/32

Universal wrenches must not be used with impact drivers. Maximum operating angle is 30°.

3/8" Sq. Dr. IronBand™ Univ. Wrenches, SAE - Extension

6 Point Standard and Tension Type



Part Number Standard	Part Number Tension	Hex Open. In.	OA L. (A) In.	Soc. L. (B) In.	Soc. Dia. (C) In.	Nose Dia. (D) In.	Clear. Depth (E) In.
KAW-C-43-6	KDW-C-43-6	3/8	6	.81	.63	.53	.44
KAW-C-44-6	KDW-C-44-6	7/16	6	.88	.63	.63	.50
KAW-C-45-6	KDW-C-45-6	1/2	6	.88	.69	.69	.50
KAW-C-104-9	-	1/2	9	1.00	.75	.75	.56
-	KDW-C-104-12	1/2	12	1.00	.75	.75	.56
KAW-C-105-6	KDW-C-105-6	9/16	6	1.00	.81	.81	.56

Universal wrenches must not be used with impact drivers. Maximum operating angle is 30°.

3/8" Sq. Dr. Socket Head Bits, SAE

Complete, Adapter Only, Insert Only

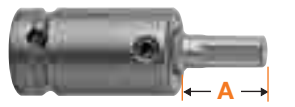

Complete	Part Number Adapter Only	Insert Only	Hex Size	Overall Length In.	Length of Insert (A) In.		
SZ-10	SC-314	SZ-10-A	1/8	2 1/4	57	1 3/8	35
SZ-11	SC-314	SZ-11-A	5/32	2 1/4	57	1 3/8	35
SZ-12	SC-314	SZ-12-A	3/16	2 1/4	57	1 3/8	35
SZ-13	SC-314	SZ-13-A	7/32	2 1/4	57	1 3/8	35
SZ-14	SC-314	SZ-14-A	1/4	2 1/4	57	1 3/8	35
SZ-15	SC-314	SZ-15-A	5/16	2 1/4	57	1 3/8	35
SZ-16	SC-314	SZ-16-A	3/8	2 1/4	57	1 3/8	35

See page 35 for more 3/8" drive complete socket head bits.

3/8" Square Drive Sockets, Metric

6 Point & 12 Point, Short and Standard Length

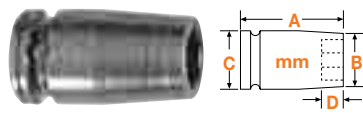

Part Number 6 Point	Part Number 12 Point	Hex Opening mm	Overall Length (A)	Diameter Nose End (B)	Diameter Drive End (C)	Opening Depth (D)
6mm13	-	6	31.7	11.1	19.1	3.9
7mm03	-	7	22.2	11.1	19.1	3.0
7mm13	-	7	31.7	11.1	19.1	4.8
8mm03	-	8	22.2	12.7	19.1	4.8
8mm13	8mm13-D	8	31.7	12.7	19.1	4.8
OS-8mm13*	-	8	31.7	11.7	15.7	4.8
9mm13	9mm13-D	9	31.7	15.1	19.1	4.8
10mm03	10mm03-D	10	22.2	16.8	19.1	6.4
OS-10mm03*	-	10	22.1	15.7	15.7	6.4
10mm13	10mm13-D	10	31.7	16.8	19.1	6.4
11mm03	11mm03-D	11	22.2	17.5	19.1	7.2
11mm13	11mm13-D	11	31.7	17.5	19.1	7.2
12mm03	12mm03-D	12	22.2	19.1	19.1	7.2
12mm13	12mm13-D	12	38.1	19.1	19.1	7.2
13mm03	13mm03-D	13	22.2	20.6	20.6	7.9
13mm13	13mm13-D	13	38.1	20.6	20.6	8.7
14mm03	14mm03-D	14	22.2	22.2	22.2	7.9
14mm13	14mm13-D	14	38.1	22.2	22.2	11.1
15mm03	15mm03-D	15	23.8	22.2	22.2	9.5
15mm13	15mm13-D	15	38.1	22.2	22.2	11.1
16mm03	16mm03-D	16	25.4	23.8	23.8	11.1
16mm13	16mm13-D	16	38.1	23.8	23.8	11.1
17mm03	-	17	25.4	25.4	25.4	11.1
17mm13	17mm13-D	17	38.1	25.4	25.4	11.1
18mm03	-	18	25.4	25.4	25.4	11.1
18mm13	18mm13-D	18	38.1	25.4	25.4	11.1
19mm03	19mm03-D	19	25.4	28.6	28.6	11.1
19mm13	19mm13-D	19	38.1	28.6	28.6	11.9
20mm03	-	20	25.4	28.6	28.6	11.1
21mm03	-	21	25.4	31.7	31.7	11.1
21mm13	-	21	38.1	31.7	31.7	13.5
22mm03	-	22	25.4	31.7	31.7	11.1
22mm13	-	22	38.1	31.7	31.7	14.3

*No ring groove.

6 Point & Double Hex, Thin Wall, Standard Length



Part Number 6 Point	Part Number 12 Point	Hex Opening mm	Overall Length (A)	Diameter Nose End (B)	Diameter Drive End (C)	Opening Depth (D)
6mm43	-	6	31.7	9.5	19.1	3.9
7mm43	7mm43-D	7	31.7	11.1	19.1	4.8
8mm43	8mm43-D	8	31.7	12.7	19.1	4.8
9mm43	9mm43-D	9	31.7	12.7	19.1	4.8
10mm43	10mm43-D	10	31.7	15.1	19.1	6.4
11mm43	-	11	38.1	15.9	19.1	7.2
12mm43	12mm43-D	12	38.1	17.5	19.1	7.2
13mm43	13mm43-D	13	38.1	19.1	19.1	8.7
14mm43	14mm43-D	14	38.1	19.8	20.6	11.1
15mm43	15mm43-D	15	38.1	20.6	20.6	11.1
16mm43	16mm43-D	16	38.1	22.2	22.2	11.1
17mm43	17mm43-D	17	38.1	23.8	23.8	11.1
18mm43	-	18	38.1	23.8	23.8	11.1
19mm43	19mm43-D	19	38.1	25.4	25.4	11.9

6 Point & Double Hex, Long and Extra Long Length



Part Number 6 Point	Part Number 12 Point	Hex Opening mm	Overall Length (A)	Diameter Nose End (B)	Diameter Drive End (C)	Opening Depth (D)
7mm23	-	7	50.8	11.1	19.1	4.8
8mm23	8mm23-D	8	50.8	12.7	19.1	4.8
9mm23	9mm23-D	9	50.8	15.1	19.1	4.8
10mm23	10mm23-D	10	50.8	16.8	19.1	6.4
OS-10mm23*	OS-10mm23-D*	10	50.8	14.2	15.9	6.4
10mm33	-	10	88.9	16.8	19.1	6.4
11mm23	11mm23-D	11	50.8	17.5	19.1	7.2
12mm23	12mm23-D	12	50.8	19.1	19.1	7.2
13mm23	13mm23-D	13	50.8	20.6	20.6	8.7
13mm33	-	13	88.9	20.6	20.6	8.7
14mm23	14mm23-D	14	50.8	22.2	22.2	11.1
15mm23	15mm23-D	15	50.8	22.2	22.2	11.1
15mm33	15mm33-D	15	88.9	22.2	22.2	11.1
16mm23	16mm23-D	16	50.8	23.8	23.8	11.1
17mm23	17mm23-D	17	50.8	25.4	25.4	11.1
18mm23	18mm23-D	18	50.8	25.4	25.4	11.1
19mm23	19mm23-D	19	50.8	28.6	28.6	11.9
21mm23	-	21	50.8	31.7	31.7	13.5
22mm23	-	22	50.8	31.7	31.7	14.3

*No ring groove.

Magnetic, Short & Standard Length

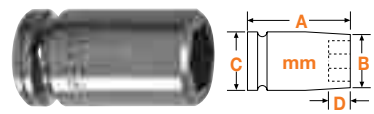

Part Number Fixed Magnet	Hex Opening mm	Overall Length (A)	Diameter Nose End (B)	Diameter Drive End (C)	Opening Depth (D)
M-6mm13	6	31.8	11.1	19.1	3.9
M-7mm13	7	31.8	11.1	19.1	4.8
M-8mm13	8	31.8	12.7	19.1	4.8
M-9mm13	9	31.8	15.1	19.1	4.8
M-10mm03	10	22.2	16.8	19.1	6.4
M-10mm13	10	31.8	16.8	19.1	6.4
M-11mm03	11	22.2	17.5	19.1	7.2
M-11mm13	11	31.7	17.5	19.1	7.2
M-12mm03	12	22.2	19.1	19.1	7.2
M-12mm13	12	38.1	19.1	19.1	7.2
M-13mm03	13	22.2	20.6	20.6	8.7
M-13mm13	13	38.1	20.6	20.6	8.7
M-14mm13	14	38.1	22.2	22.2	11.1
M-15mm03	15	23.8	22.2	22.2	9.5
M-15mm13	15	38.1	22.2	22.2	11.1
M-16mm13	16	38.1	23.8	23.8	11.1
M-17mm13	17	38.1	25.4	25.4	11.1
M-18mm03	18	25.4	25.4	25.4	11.1
M-18mm13	18	38.1	25.4	25.4	11.1

3/8" Square Drive Sockets, Metric

Magnetic, Thin Wall, Standard Length



Part Number Fixed Magnet	Hex Opening mm	Overall Length (A)	Diameter Nose End (B)	Diameter Drive End (C)	Opening Depth (D)
M-8mm43	8	31.7	12.7	19.1	4.8
M-10mm43	10	31.7	15.1	19.1	6.4
M-11mm43	11	38.1	15.9	19.1	7.2
M-12mm43	12	38.1	17.5	19.1	7.2
M-13mm43	13	38.1	19.1	19.1	8.7
M-14mm43	14	38.1	19.8	20.6	11.1
M-15mm43	15	38.1	20.5	20.6	11.1

Magnetic, Long & Extra Long Length



Part No. Fixed Magnet	Hex Opening mm	Overall Length (A)	Diameter Nose End (B)	Diameter Drive End (C)	Opening Depth (D)
MB-6mm23	6	50.8	11.1	19.1	3.9
MB-7mm23	7	50.8	11.1	19.1	4.8
MB-8mm23	8	50.8	12.7	19.1	4.8
OSMB-8mm23*	8	50.8	11.7	15.9	4.8
MB-9mm23	9	50.8	15.1	19.1	4.8
MB-10mm23	10	50.8	16.8	19.1	6.4
OSMB-10mm23*	10	50.8	14.2	15.9	6.4
MB-10mm33	10	88.9	16.8	19.1	6.4
MB-11mm23	11	50.8	17.5	19.1	7.2
MB-12mm23	12	50.8	19.1	19.1	7.2
MB-13mm23	13	50.8	20.6	20.6	8.7
MB-13mm33	13	88.9	20.6	20.6	8.7
MB-14mm23	14	50.8	22.2	22.2	11.1
MB-15mm23	15	50.8	22.2	22.2	11.1
MB-15mm33	15	88.9	22.2	22.2	11.1
MB-16mm23	16	50.8	23.8	23.8	11.1
MB-17mm23	17	50.8	25.4	25.4	11.1
MB-18mm23	18	50.8	25.4	25.4	11.1

*No ring groove.

Surface Drive, Short and Standard Length



Part Number Fixed Magnet	Hex Opening mm	Overall Length (A)	Diameter Nose End (B)	Diameter Drive End (C)	Opening Depth (D)
SF-8mm13	8	31.7	12.7	19.1	4.8
SF-10mm03	10	22.2	16.8	19.1	6.4
SF-10mm13	10	31.7	16.8	19.1	6.4
SF-11mm13	11	31.7	17.5	19.1	7.2
SF-12mm03	12	22.2	19.1	19.1	7.2
SF-12mm13	12	38.1	19.1	19.1	7.2
SF-13mm03	13	22.2	20.6	20.6	8.7
SF-13mm13	13	38.1	20.6	20.6	8.7
SF-14mm13	14	38.1	22.2	22.2	11.1
SF-15mm03	15	23.8	22.2	22.2	11.1
SF-15mm13	15	38.1	22.2	22.2	11.1
SF-16mm13	16	38.1	23.8	23.8	11.1
SF-17mm03	17	25.4	25.4	25.4	11.1
SF-17mm13	17	38.1	25.4	25.4	11.1
SF-18mm13	18	38.1	25.4	25.4	11.1
SF-19mm13	18	38.1	28.6	28.6	11.9

Surface Drive, Thin Wall, Standard Length

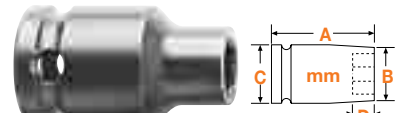

Part Number Surface Drive	Hex Opening mm	Overall Length (A)	Diameter Nose End (B)	Diameter Drive End (C)	Opening Depth (D)
SF-10mm43	10	31.7	15.1	19.1	6.4
OSSF-10mm43*	10	31.7	15.1	15.1	6.4
SF-11mm43	11	38.1	15.9	19.1	7.2
SF-12mm43	12	38.1	17.5	19.1	7.2
SF-13mm43	13	38.1	19.1	19.1	8.7
SF-15mm43	15	38.1	20.6	20.6	11.1
SF-17mm43	17	38.1	23.8	23.8	11.1
SF-18mm43	18	38.1	23.8	23.8	11.1
SF-19mm43	19	38.1	25.4	25.4	11.9

*No ring groove.

Surface Drive, Long & Extra Long Length



Part Number Surface Drive	Hex Opening mm	Overall Length (A)	Diameter Nose End (B)	Diameter Drive End (C)	Opening Depth (D)
SF-8mm23	8	50.8	12.7	19.1	4.8
OSSF-8mm23*	8	50.8	11.9	15.9	4.8
SF-10mm23	10	50.8	16.8	19.1	6.4
OSSF-10mm23*	10	50.8	14.2	15.9	6.4
SF-10mm33	10	88.9	16.8	19.1	6.4
SF-11mm23	11	50.8	17.5	19.1	7.2
SF-12mm23	12	50.8	19.1	19.1	7.2
SF-13mm23	13	50.8	20.6	20.6	8.7
SF-13mm33	13	88.9	20.6	20.6	8.7
SF-15mm23	15	50.8	22.2	22.2	11.1
SF-15mm33	15	88.9	22.2	22.2	11.1
SF-17mm23	17	50.8	25.4	25.4	11.1
SF-18mm23	18	50.8	25.4	25.4	11.1
SF-19mm23	19	50.8	28.6	28.6	11.9

*No ring groove.

3/8" Sq. Dr. Sockets For Metric Sheet Metal Screws

6 Point & 6 Point Magnetic, for Predrilled Holes

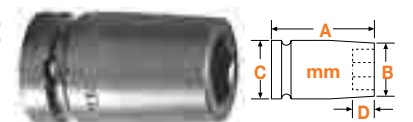

Part Number 6 Point	Part Number Magnetic	Hex Opening mm	Overall Length (A)	Diameter Nose End (B)	Diameter Drive End (C)	Opening Depth (D)
-	M-6mmE3	6	31.7	11.1	19.1	3.9
-	M-7mmE3	7	31.7	11.9	19.1	4.8
8mmE3	M-8mmE3	8	31.7	12.7	19.1	4.8
10mmE3	M-10mmE3	10	31.7			

3/8" Sq. Dr. Socket Sets, Metric 6 Point



APS312M	12 piece, standard length: 7mm, 8mm, 9mm, 10mm, 11mm, 12mm, 13mm, 14mm, 15mm, 16mm, 17mm, 18mm
APS312LM	12 piece, long length: 7mm, 8mm, 9mm, 10mm, 11mm, 12mm, 13mm, 14mm, 15mm, 16mm, 17mm, 18mm

3/8" Sq. Dr. IronBand™ Universal Wrenches, Metric

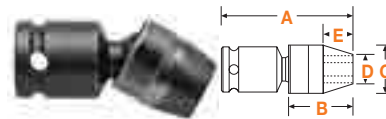

6 Point

Part Number	Hex Opening mm	Overall Length (A) mm	Socket Length (B) mm	Socket Diameter (C) mm	Nose End Diameter (D) mm	Clearance Depth (E) mm
SA-C-36-10M	10	48	20.6	19.1	15.1	9.5
SA-C-37-12M	12	51	23.8	22.2	17.5	10.3
SA-C-37-13M	13	52	25.4	22.2	17.5	11.9
SA-C-37-14M	14	54	27.0	22.2	19.1	13.5
SA-C-38-15M	15	56	28.6	25.4	19.8	14.3
SA-C-38-17M	17	59	31.8	25.4	25.4	17.5
SA-C-38-18M	18	59	31.8	25.4	25.4	17.5

Universal wrenches must not be used with impact drivers. Maximum operating angle is 30°.

3/8" Sq. Dr. Universal Wrench Set, Metric



6 Point

APU37M	7 piece, standard length: 10mm, 12mm, 13mm, 14mm, 15mm, 17mm, 18mm
--------	---

3/8" Sq. Dr. Universal Wrenches, Metric – Extension

6 Point Standard and Tension Type



Part Number Standard	Part Number Tension	Hex Opening mm	Shank Length (A) mm	Socket Length (B) mm	Socket Diameter (C) mm	Nose End Diameter (D) mm	Clearance Depth (E) mm
KA-6-10m-4	-	10	102	20.6	19.1	15.1	9.5
KA-6-10m-6	KD-6-10m-6	10	152	20.6	19.1	15.1	9.5
KA-6-10m-9	KD-6-10m-9	10	229	20.6	19.1	15.1	9.5
-	KD-6-10m-12	10	305	20.6	19.1	15.1	9.5
-	KD-7-11m-6	11	152	23.8	22.2	15.9	10.3
KA-7-11m-12	KD-7-11m-12	11	305	23.8	22.2	15.9	10.3
KA-7-12m-4	-	12	102	23.8	22.2	17.5	10.3
KA-7-12m-6	KD-7-12m-6	12	152	23.8	22.2	17.5	10.3
KA-7-12m-9	KD-7-12m-9	12	229	23.8	22.2	17.5	10.3
KA-7-12m-12	KD-7-12m-12	12	305	23.8	22.2	17.5	10.3
KA-7-13m-3	-	13	76	25.4	22.2	17.5	11.9
KA-7-13m-4	-	13	102	25.4	22.2	17.5	11.9
KA-7-13m-6	KD-7-13m-6	13	152	25.4	22.2	17.5	11.9
KA-7-13m-9	KD-7-13m-9	13	229	25.4	22.2	17.5	11.9
KA-7-13m-12	KD-7-13m-12	13	305	25.4	22.2	17.5	11.9
KA-7-14m-6	KD-7-14m-6	14	152	27.0	22.2	19.1	13.5
-	KD-7-14m-9	14	229	27.0	22.2	19.1	13.5
KA-8-15m-3	-	15	76	28.6	25.4	19.8	14.3
-	KD-8-15m-6	15	152	28.6	25.4	19.8	14.3
KA-8-15m-9	KD-8-15m-9	15	229	28.6	25.4	19.8	14.3
KA-8-15m-12	KD-8-15m-12	15	305	28.6	25.4	19.8	14.3

Universal wrenches must not be used with impact drivers. Maximum operating angle is 30°.

3/8" Sq. Dr. IronBand™ Univ. Wrenches, Metric

6 Point Standard and Tension Type



Part Number Standard	Part Number Tension	Hex Open. mm	OA L. (A) mm	Soc. L. (B) mm	Soc. Dia. (C) mm	Nose Dia. (D) mm	Clear. Depth (E) mm
KAW-C-6-10M-6	KDW-C-6-10M-6	10	152	20.6	19.1	15.1	9.5
KAW-C-6-10M-9	KDW-C-6-10M-9	10	229	20.6	19.1	15.1	9.5
KAW-C-7-12M-6	KDW-C-7-12M-6	12	152	23.8	22.2	17.5	10.3
KAW-C-7-12M-12	KDW-C-7-12M-12	12	305	23.8	22.2	17.5	10.3
KAW-C-7-13M-6	KDW-C-7-13M-6	13	152	25.4	22.2	17.5	11.9
KAW-C-7-13M-12	KDW-C-7-13M-12	13	305	25.4	22.2	17.5	11.9
KAW-C-7-14M-6	KDW-C-7-14M-6	14	152	27.0	22.2	19.1	13.5
KAW-C-8-15M-9	KDW-C-8-15M-9	15	229	28.6	25.4	19.8	14.3

Universal wrenches must not be used with impact drivers. Maximum operating angle is 30°.

3/8" Sq. Dr. Socket Head Bits, Metric

Complete, Adapter Only, Insert Only



Complete	Part Number Adapter Only	Insert Only	Hex Size	Overall Length In.	Overall Length mm	Length of Insert (A) In.	Length of Insert (A) mm
SZ-3-7-4mm	SC-314	SZ-7-4mm	4mm	2 1/4	57	1 3/8	35
SZ-3-7-5mm	SC-314	SZ-7-5mm	5mm	2 1/4	57	1 3/8	35
SZ-3-7-6mm	SC-314	SZ-7-6mm	6mm	2 1/4	57	1 3/8	35
SZ-3-7-8mm	SC-314	SZ-7-8mm	8mm	2 1/4	57	1 3/8	35
SZ-3-7-10mm	SC-314	SZ-7-10mm	10mm	2 1/4	57	1 3/8	35

See page 19 for more 3/8" drive complete socket head bits.

3/8" Sq. Dr. Sockets For Spline Fasteners

Standard and Long Length



Part Number	Spline Size	Nominal Size	Overall Length (A) In.	Overall Length (A) mm	Diameter Nose End (B) In.	Diameter Nose End (B) mm	Diameter Drive End (C) In.	Diameter Drive End (C) mm
CMS-3412	12	3/8	1	25	17/32	14	21/32	17
CMS-3512	12	3/8	2 1/8	54	17/32	14	21/32	17
CMS-3414	14	7/16	1 1/16	27	5/8	16	11/16	18
CMS-3416	16	1/2	1 1/16	27	23/32	18	23/32	18
CMS-3418	18	9/16	1 1/16	27	13/16	21	13/16	21
CMS-3518	18	9/16	2 3/8	60	13/16	21	13/16	21
CMS-3420	20	5/8	1 3/16	30	7/8	22	7/8	22

Apex spline sockets conform to military specifications MS-37787 and MIL-W-8982C.

3/8" Sq. Dr. Torx® Sockets

For External Torx Screws



Part Number	Driver Size	Overall Length (A) In.	Overall Length (A) mm	Nose End Diameter (B) In.	Nose End Diameter (B) mm	Drive End Diameter (C) In.	Drive End Diameter (C) mm
TX-3106	E-6	1 1/4	32	3/8	10	3/4	19
TX-3107	E-7	1 1/4	32	3/8	10	3/4	19
TX-3108	E-8	1 1/4	32	7/16	11	3/4	19
TX-3110	E-10	1 1/4	32	1/2	13	3/4	19
TX-3112	E-12	1 1/4	32	5/8	16	3/4	19
TX-3114	E-14	1 1/4	32	11/16	18	3/4	19
TX-3116	E-16	1 1/4	32	13/16	21	13/16	21

For External Torx Screws, Thin Wall



Part Number	Driver Size	Overall Length (A) In.	Overall Length (A) mm	Nose End Diameter (B) In.	Nose End Diameter (B) mm	Drive End Diameter (C) In.	Drive End Diameter (C) mm
TX-3406	E-6	1 1/4	32	5/16	8	5/8	16
TX-3407	E-7	1 1/4	32	11/32	9	5/8	16
TX-3408	E-8	1 1/4	32	3/8	10	5/8	16
TX-3508	E-8	2	51	3/8	10	5/8	16
TX-3410	E-10	1 1/4	32	1/2	13	5/8	16
TX-3412	E-12	1 1/4	32	9/16	14	5/8	16
TX-3414	E-14	1 1/4	32	5/8	16	3/4	19

Some Torx® sockets have a DIN (pin and o-ring) groove.

For Torx Nuts



Part Number	Driver Size	Overall Length (A) In.	Overall Length (A) mm	Nose End Diameter (B) In.	Nose End Diameter (B) mm	Drive End Diameter (C) In.	Drive End Diameter (C) mm
TX-3E08	E-8	1 1/4	32	5/8	16	5/8	16
TX-3E10	E-10	1 1/4	32	5/8	16	5/8	16

Sockets for Torx® nuts have a larger lead-in chamfer than sockets for external Torx® screws. Most Torx® sockets have a DIN (pin and o-ring) groove.

3/8" Sq. Dr. Extensions

1 1/4" to 18" (32mm to 457mm)
Length



Part Number	Male Square In.	Type of Lock	Overall Length In.	Overall Length mm
EX-374	3/8	Pin	1 3/8	34
EX-374-B	3/8	Ball	1 3/8	34
EX-376-2	3/8	Pin	2	51
EX-376-B-2	3/8	Ball	2	51
EX-376-3	3/8	Pin	3	76
EX-376-B-3	3/8	Ball	3	76
EX-376-4	3/8	Pin	4	102
EX-376-B-4	3/8	Ball	4	102
EX-376-5	3/8	Pin	5	127
EX-376-B-5	3/8	Ball	5	127
EX-376-6	3/8	Pin	6	152
EX-376-B-6	3/8	Ball	6	152
EX-376-8	3/8	Pin	8	203
EX-376-B-8	3/8	Ball	8	203
EX-376-9	3/8	Pin	9	229
EX-376-B-9	3/8	Ball	9	229
EX-376-10	3/8	Pin	10	254
EX-376-B-10	3/8	Ball	10	254
EX-376-12	3/8	Pin	12	305
EX-376-B-12	3/8	Ball	12	305
EX-376-15	3/8	Pin	15	381
EX-376-B-15	3/8	Ball	15	381
EX-376-18	3/8	Pin	18	457

3/8" Sq. Dr. Adapters

1/4" to 3/4"
Male Square



Part Number	Male Square In.	Female Square In.	Type of Lock	Overall Length In.	Overall Length mm
EX-254	1/4	3/8	Pin	1 1/4	32
EX-254-B	1/4	3/8	Ball	1 1/4	32
EX-257-2	1/4	3/8	Pin	2	51
EX-257-B-2	1/4	3/8	Ball	2	51
EX-257-3	1/4	3/8	Pin	3	76
EX-257-B-3	1/4	3/8	Ball	3	76
EX-257-4	1/4	3/8	Pin	4	102
EX-257-B-4	1/4	3/8	Ball	4	102
EX-257-5	1/4	3/8	Pin	5	127
EX-257-B-5	1/4	3/8	Ball	5	127
EX-257-6	1/4	3/8	Pin	6	152
EX-257-B-6	1/4	3/8	Ball	6	152
EX-503	1/2	3/8	Pin	1 1/2	38
EX-503-B	1/2	3/8	Ball	1 1/2	38
EX-507-2	1/2	3/8	Pin	2	51
EX-507-3	1/2	3/8	Pin	3	76
EX-507-B-3	1/2	3/8	Ball	3	76
EX-507-4	1/2	3/8	Pin	4	102
EX-507-B-4	1/2	3/8	Ball	4	102
EX-507-6	1/2	3/8	Pin	6	152
EX-507-B-6	1/2	3/8	Ball	6	152
EX-622	5/8	3/8	Pin	1 1/2	38
EX-750	3/4	3/8	7/32 Drill Hole	1 1/2	38
EX-750-B	3/4	3/8	Ball	1 1/2	38

3/8" Sq. Dr. Universal Adapters

Male Square to Female Square



Part Number	Male Sq. In.	Female Sq. In.	Type of Lock	Overall Length In.	Overall Length mm	Largest Diameter In.	Largest Diameter mm
MF-27	1/4	3/8	Pin	1 5/16	49	3/4	19
MF-27-B	1/4	3/8	Ball	1 5/16	49	3/4	19
MF-37	3/8	3/8	Pin	2 1/8	54	3/4	19
MF-37-B	3/8	3/8	Ball	2 1/8	54	3/4	19
MF-38-B	3/8	3/8	Ball	2 1/2	64	7/8	22

Universal wrenches must not be used with impact drivers.
Maximum operating angle is 30°.

3/8" Sq. Dr. Universal Adapters - Extension



(Standard Type Shown)

Male Square to Female Square

Part No. Standard	Part No. Tension	Male Square In.	Female Square In.	Type of Lock	Largest Diameter In.	Largest Diameter mm
KAM-37-3	KDM-37-3	3/8	3/8	Pin	3/4	19
-	KDM-37-6	3/8	3/8	Pin	3/4	19
-	KDM-37-B-3	3/8	3/8	Ball	3/4	19
KAM-38-6	KDM-38-6	3/8	3/8	Pin	7/8	22

Standard lengths are 3", 6", 9" and 12" (76, 152, 229 and 305mm)

1/2" Square Drive Sockets, SAE

6 Point and Double Hex, Standard Length

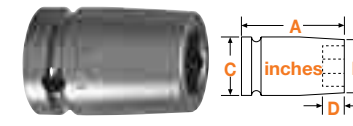

Part Number 6 Point	Part Number Double Hex	Hex Opening In.	Overall Length (A)	Diameter Nose End (B)	Diameter Drive End (C)	Opening Depth (D)
5108	-	1/4	1 1/2	7/16	15/16	5/32
5110	5110-D	5/16	1 1/2	1/2	15/16	3/16
5112	5112-D	3/8	1 1/2	5/8	15/16	1/4
5114	5114-D	7/16	1 1/2	11/16	15/16	9/32
5116	5116-D	1/2	1 1/2	13/16	15/16	11/32
SH-335	-	1/2	1 1/2	45/64	15/16	11/32
5118	5118-D	9/16	1 1/2	7/8	15/16	7/16
SH-336	SH-336-D	9/16	1 1/2	27/32	15/16	7/16
5119	-	19/32	1 1/2	15/16	15/16	7/16
5120	5120-D	5/8	1 1/2	1	1	7/16
SH-338	SH-338-D	5/8	1 1/2	15/16	1	7/16
5122	5122-D	11/16	1 1/2	1 1/8	1 1/8	7/16
SH-339	-	11/16	1 1/2	1 1/64	1 1/16	7/16
SW-282	SW-282-D	3/4	1 1/2	1 1/4	1 1/4	15/32
5124	5124-D	3/4	1 1/2	1 1/8	1 1/8	15/32
5126	5126-D	13/16	1 1/2	1 1/4	1 1/4	17/32
5128	5128-D	7/8	1 1/2	1 5/16	1 5/16	9/16
5130	5130-D	15/16	1 1/2	1 3/8	1 3/8	5/8
5131	-	31/32	1 1/2	1 1/2	1 1/2	5/8
5132	5132-D	1	1 1/2	1 1/2	1 1/2	5/8
5134	5134-D	1 1/16	1 5/8	1 1/2	1 1/2	11/16
5136	5136-D	1 1/8	1 5/8	1 5/8	1 5/8	3/4
5138	5138-D	1 3/16	1 5/8	1 3/4	1 3/4	3/4
5140	5140-D	1 1/4	1 3/4	1 3/4	1 3/4	13/16
5142	-	1 5/16	1 3/4	1 7/8	1 7/8	13/16
5144	5144-D	1 3/8	1 7/8	2	2	13/16
5146	-	1 7/16	2	2	2	15/16
5148	5148-D	1 1/2	2	2 1/8	2 1/8	1
5152	5152-D	1 5/8	2	2 3/8	2 3/8	1 1/8
5154	-	1 11/16	2	2 3/8	2 3/8	1 1/8
5156	-	1 3/4	2	2 1/2	2 1/2	1 1/8

6 Point and Double Hex, Thin Wall, Standard Length



Part Number 6 Point	Part Number Double Hex	Hex Opening In.	Overall Length (A)	Diameter Nose End (B)	Diameter Drive End (C)	Opening Depth (D)
5412	5412-D	3/8	1 1/2	19/32	15/16	1/4
5414	5414-D	7/16	1 1/2	21/32	15/16	9/32
5416	5416-D	1/2	1 1/2	23/32	15/16	11/32
5418	5418-D	9/16	1 1/2	13/16	15/16	7/16
5420	5420-D	5/8	1 1/2	7/8	15/16	7/16
5421	5421-D	21/32	1 1/2	29/32	15/16	7/16
*5422	*5422-D	11/16	1 1/2	15/16	15/16	7/16
OS-5424**	-	3/4	1 1/2	1 1/32	1 1/32	15/32
5424	5424-D	3/4	1 1/2	1 1/32	1 1/8	15/32
5426	5426-D	13/16	1 1/2	1 1/8	1 1/8	17/32
HE-1028	HE-1028-D	7/8	1 1/2	1 1/4	1 1/4	9/16
*5428	-	7/8	1 1/2	1 3/16	1 1/4	9/16
HE-530	-	15/16	1 1/2	1 5/16	1 5/16	5/8

* Extra thin wall
** No ring groove

Continued on next column.

6 Point and Double Hex, Thin Wall, Standard Length



Continued from previous column.

Part Number 6 Point	Part Number Double Hex	Hex Opening In.	Overall Length (A)	Diameter Nose End (B)	Diameter Drive End (C)	Opening Depth (D)
*5430	*5430-D	15/16	1 1/2	1 1/4	1 1/4	5/8
5432	5432-D	1	1 1/2	1 3/8	1 3/8	5/8
5434	5434-D	1 1/16	1 5/8	1 7/16	1 7/16	11/16
5436	5436-D	1 1/8	1 5/8	1 1/2	1 1/2	3/4
5438	-	1 3/16	1 5/8	1 5/8	1 5/8	3/4
5440	5440-D	1 1/4	1 3/4	1 11/16	1 3/4	13/16
5442	-	1 5/16	1 3/4	1 25/32	1 7/8	13/16

* Extra thin wall
** No ring groove

6 Point and Double Hex, Long & Extra Long Length



Part Number 6 Point	Part Number Double Hex	Hex Opening In.	Overall Length (A)	Diameter Nose End (B)	Diameter Drive End (C)	Opening Depth (D)
5210	-	5/16	2 1/4	1/2	15/16	3/16
5310	-	5/16	3 1/4	1/2	15/16	3/16
5212	-	3/8	2 1/4	5/8	15/16	1/4
5312	-	3/8	3 1/4	5/8	15/16	1/4
5214	-	7/16	2 1/4	11/16	15/16	9/32
5314	-	7/16	3 1/4	11/16	15/16	9/32
5216	5216-D	1/2	2 1/4	13/16	15/16	11/32
5316	5316-D	1/2	3 1/4	13/16	15/16	11/32
5218	5218-D	9/16	2 1/4	7/8	15/16	7/16
5318	5318-D	9/16	3 1/4	7/8	15/16	7/16
5220	-	5/8	2 1/4	1	1	7/16
5320	-	5/8	3 1/4	1	1	7/16
5222	-	11/16	2 1/4	1 1/8	1 1/8	7/16
5322	5322-D	11/16	3 1/4	1 1/8	1 1/8	7/16
5224	5224-D	3/4	2 1/4	1 1/8	1 1/8	15/32
5324	5324-D	3/4	3 1/4	1 1/8	1 1/8	15/32
SW-493	-	3/4	2 1/4	1 1/4	1 1/4	15/32
5226	5226-D	13/16	2 1/4	1 1/4	1 1/4	17/32
5326	-	13/16	3 1/2	1 1/4	1 1/4	17/32
5228	5228-D	7/8	2 1/4	1 5/16	1 5/16	9/16
5328	-	7/8	3 1/2	1 5/16	1 5/16	9/16
5230	5230-D	15/16	2 1/4	1 3/8	1 3/8	5/8
5330	5330-D	15/16	3 1/2	1 3/8	1 3/8	5/8
5232	-	1	2 1/4	1 1/2	1 1/2	5/8
5332	-	1	3 1/2	1 1/2	1 1/2	5/8
5234	-	1 1/16	2 3/8	1 1/2	1 1/2	11/16
5334	-	1 1/16	3 1/2	1 1/2	1 1/2	11/16
5236	5236-D	1 1/8	2 3/8	1 5/8	1 5/8	3/4
5336	5336-D	1 1/8	3 1/2	1 5/8	1 5/8	3/4
5238	-	1 3/16	2 3/8	1 3/4	1 3/4	3/4
5338	-	1 3/16	3 1/2	1 3/4	1 3/4	3/4
5240	5240-D	1 1/4	2 1/2	1 3/4	1 3/4	13/16
5340	5340-D	1 1/4	3 1/2	1 3/4	1 3/4	13/16
5242	-	1 5/16	2 1/2	1 7/8	1 7/8	13/16
5342	-	1 5/16	3 1/2	1 7/8	1 7/8	13/16
5244	-	1 3/8	2 1/2	2	2	13/16
5344	-	1 3/8	3 5/8	2	2	13/16
5248	-	1 1/2	2 1/2	2 1/8	2 1/8	1
5348	-	1 1/2	3 3/4	2 1/8	2 1/8	1

1/2" Square Drive Sockets, SAE

6 Point and Double Hex, Thin Wall, Extra Long Length



Part Number 6 Point	Part Number Double Hex	Hex Opening In.	Overall Length (A)	Diameter Nose End (B)	Diameter Drive End (C)	Opening Depth (D)
5510	-	5/16	3 1/4	1/2	15/16	3/16
5512	5512-D	3/8	3 1/4	19/32	15/16	1/4
5514	5514-D	7/16	3 1/4	21/32	15/16	9/32
5516	5516-D	1/2	3 1/4	23/32	15/16	11/32
OS-5516*	-	1/2	3 1/4	47/64	7/8	11/32
5518	5518-D	9/16	3 1/4	13/16	15/16	7/16
OS-5518*	-	9/16	3 1/4	13/16	27/32	7/16
5520	5520-D	5/8	3 1/4	7/8	15/16	7/16
5522	5522-D	11/16	3 1/4	15/16	15/16	7/16
5524	5524-D	3/4	3 1/4	1 1/32	1 1/8	15/32
5526	5526-D	13/16	3 1/2	1 1/8	1 1/8	17/32
5528	5528-D	7/8	3 1/2	1 3/16	1 1/4	9/16
5530	5530-D	15/16	3 1/2	1 1/4	1 1/4	5/8
5532	5532-D	1	3 1/2	1 3/8	1 3/8	5/8
5534	5534-D	1 1/16	3 1/2	1 7/16	1 7/16	11/16

* No ring groove.

Magnetic, Standard Length

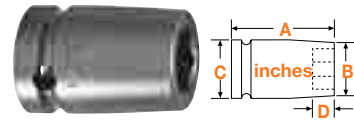

Part Number Fixed Magnet	Hex Opening In.	Overall Length (A)	Diameter Nose End (B)	Diameter Drive End (C)	Opening Depth (D)
M-5110	5/16	1 1/2	1/2	15/16	3/16
M-5112	3/8	1 1/2	5/8	15/16	1/4
M-5114	7/16	1 1/2	11/16	15/16	9/32
M-5116	1/2	1 1/2	13/16	15/16	11/32
MSH-335	1/2	1 1/2	45/64	15/16	11/32
M-5118	9/16	1 1/2	7/8	15/16	7/16
MSH-336	9/16	1 1/2	27/32	15/16	7/16
M-5120	5/8	1 1/2	1	1	7/16
M-5122	11/16	1 1/2	1 1/8	1 1/8	7/16
M-5124	3/4	1 1/2	1 1/8	1 1/8	15/32

Magnetic, Thin Wall, Standard Length

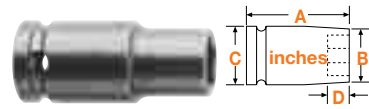

Part Number Fixed Magnet	Hex Opening In.	Overall Length (A)	Diameter Nose End (B)	Diameter Drive End (C)	Opening Depth (D)
M-5416	1/2	1 1/2	23/32	15/16	11/32
M-5418	9/16	1 1/2	13/16	15/16	7/16
M-5420	5/8	1 1/2	7/8	15/16	7/16

Magnetic, Long Length & Extra Long Length



Part No. Fixed Magnet	Part No. Bolt Clearance	Hex Opening In.	Overall Length (A)	Diameter Nose End (B)	Diameter Drive End (C)	Opening Depth (D)
-	MB-5212	3/8	2 1/4	5/8	15/16	1/4
M-5512*	-	3/8	3 1/4	19/32	15/16	1/4
-	MB-5214	7/16	2 1/4	11/16	15/16	9/32
M-5216	MB-5216	1/2	2 1/4	13/16	15/16	11/32
M-5316	-	1/2	3 1/4	13/16	15/16	11/32
M-5218	-	9/16	2 1/4	7/8	15/16	7/16
-	MB-HE9518	9/16	2 1/4	7/8	15/16	7/16
M-5518*	-	9/16	3 1/4	13/16	15/16	7/16
-	MB-5220	5/8	2 1/4	1	1	7/16

*Thin Wall

Surface Drive & Fast Lead, Standard Length

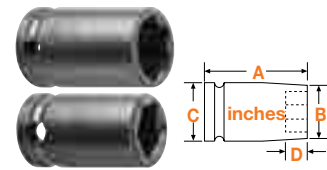

Part No. Fixed Magnet	Part No. Fast Lead	Hex Opening In.	Overall Length (A)	Diameter Nose End (B)	Diameter Drive End (C)	Opening Depth (D)
SF-5112	-	3/8	1 1/2	5/8	15/16	1/4
-	FL-5114	7/16	1 1/2	11/16	15/16	9/32
SF-5116	FL-5116	1/2	1 1/2	13/16	15/16	11/32
SF-SH-335	FL-SH-335	1/2	1 1/2	45/64	15/16	11/32
SF-5118	FL-5118	9/16	1 1/2	7/8	15/16	7/16
SF-SH-336	-	9/16	1 1/2	27/32	15/16	7/16
SF-5120	FL-5120	5/8	1 1/2	1	1	7/16
SF-5122	FL-5122	11/16	1 1/2	1 1/8	1 1/8	7/16
SF-5124	FL-5124	3/4	1 1/2	1 1/8	1 1/8	15/32
SF-SW-282	-	3/4	1 1/2	1 1/4	1 1/4	15/32
SF-5126	FL-5126	13/16	1 1/2	1 1/4	1 1/4	17/32
SF-5128	FL-5128	7/8	1 1/2	1 5/16	1 5/16	9/16
SF-5130	FL-5130	15/16	1 1/2	1 3/8	1 3/8	5/8
SF-5132	FL-5132	1	1 1/2	1 1/2	1 1/2	5/8
SF-5134	FL-5134	1 1/16	1 5/8	1 1/2	1 1/2	11/16

Surface Drive & Fast Lead, Thin Wall, Standard Length

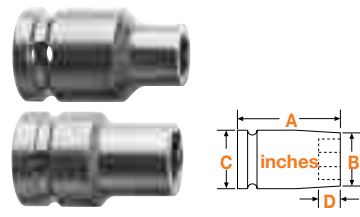

Part No. Fixed Magnet	Part No. Fast Lead	Hex Opening In.	Overall Length (A)	Diameter Nose End (B)	Diameter Drive End (C)	Opening Depth (D)
SF-5412	-	3/8	1 1/2	19/32	15/16	1/4
SF-5414	-	7/16	1 1/2	21/32	15/16	9/32
SF-5416	FL-5416	1/2	1 1/2	23/32	15/16	11/32
SF-5418	FL-5418	9/16	1 1/2	13/16	15/16	7/16
SF-5420	-	5/8	1 1/2	7/8	15/16	7/16
SF-5422	-	11/16	1 1/2	15/16	15/16	7/16
SF-5424	-	3/4	1 1/2	1 1/32	1 1/8	15/32
SF-5426	-	13/16	1 1/2	1 1/8	1 1/8	17/32

1/2" Sq. Dr. Sockets, SAE

Surface Drive & Fast Lead, Long and Extra Long Length

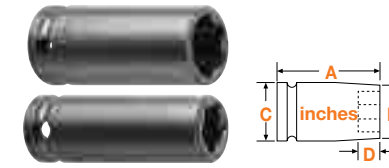

Part No. Surface Drive	Part No. Fast Lead	Hex Opening In.	Overall Length (A)	Diameter Nose End (B)	Diameter Drive End (C)	Opening Depth (D)
SF-5212	-	3/8	2 1/4	9/16	15/16	9/32
SF-5216	FL-5216	1/2	2 1/4	13/16	15/16	11/32
-	FL-5316	1/2	3 1/4	13/16	15/16	11/32
SF-HE-9518	FL-HE-9518	9/16	2 1/4	7/8	7/8	7/16
SF-5218	FL-5218	9/16	2 1/4	7/8	15/16	7/16
SF-5318	FL-5318	9/16	3 1/4	7/8	15/16	7/16
SF-5320	FL-5320	5/8	3 1/4	1	1	7/16
SF-5222	FL-5222	11/16	2 1/4	1 1/8	1 1/8	7/16
SF-5224	FL-5224	3/4	2 1/4	1 1/8	1 1/8	15/32
-	FL-SW-493	3/4	2 1/4	1 1/4	1 1/4	15/32
SF-5324	FL-5324	3/4	3 1/4	1 1/8	1 1/8	15/32
SF-5226	FL-5226	13/16	2 1/4	1 1/4	1 1/4	17/32
-	FL-5326	13/16	3 1/2	1 1/4	1 1/4	17/32
SF-5228	FL-5228	7/8	2 1/4	1 5/16	1 5/16	9/16
SF-5328	-	7/8	3 1/2	1 5/16	1 5/16	9/16
SF-5230	-	15/16	2 1/4	1 3/8	1 3/8	5/8
SF-5330	-	15/16	3 1/2	1 3/8	1 3/8	5/8
SF-5232	-	1	2 1/4	1 1/2	1 1/2	5/8

Surface Drive, Thin Wall, Extra Long Length



Part No. Surface Drive	Hex Opening In.	Overall Length (A)	Diameter Nose End (B)	Diameter Drive End (C)	Opening Depth (D)
SF-5514	7/16	3 1/4	21/32	15/16	9/32
SF-5516	1/2	3 1/4	23/32	15/16	11/32
SF-5518	9/16	3 1/4	13/16	15/16	7/16
SF-5520	5/8	3 1/4	7/8	15/16	7/16
SF-5524	3/4	3 1/4	1 1/32	1 1/8	15/32
SF-5526	13/16	3 1/4	1 1/8	1 1/8	17/32
SF-5528	7/8	3 1/2	1 3/16	1 1/4	9/16
SF-5532	1	3 1/2	1 3/8	1 3/8	5/8

1/2" Sq. Dr. Sockets For SAE Sheet Metal Screws

6 Point & 6 Point Magnetic, for Predrilled Holes*

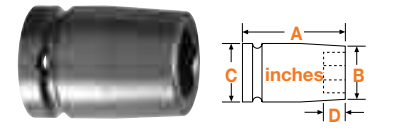

Part Number 6 Point	Part Number Magnetic	Hex Opening In.	Overall Length (A)	Diameter Nose End (B)	Diameter Drive End (C)	Opening Depth (D)
5E10	M5E10	5/16	1 1/2	1/2	15/16	3/16
5E12	M5E12	3/8	1 1/2	5/8	15/16	1/4
-	M5E14	7/16	1 1/2	11/16	15/16	9/32
5E16	M5E16	1/2	1 1/2	13/16	15/16	11/32
-	M5E18	9/16	1 1/2	15/16	15/16	7/16

6 Point & 6 Point Magnetic, for Self-Tapping Screws*

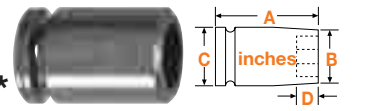

Part Number 6 Point	Part Number Magnetic	Hex Opening In.	Overall Length (A)	Diameter Nose End (B)	Diameter Drive End (C)	Opening Depth (D)
-	M5P10	5/16	1 1/2	1/2	15/16	3/16
5P12	M5P12	3/8	1 1/2	5/8	15/16	1/4
5P14	M5P14	7/16	1 1/2	11/16	15/16	9/32
-	M5P16	1/2	1 1/2	13/16	15/16	11/32
-	M5P18	9/16	1 1/2	15/16	15/16	7/16

*Sockets for predrilled holes are intermediate hardness; sockets for self-tapping screws are maximum hardness.

If the tool you need does not appear in this catalog, give us a call. The odds are, we may have what you need as a non-catalog item. If not, our experienced staff of tooling experts can design and manufacture "specials" to meet the needs of your specific application. Give us a call at 1-800-845-5629 or visit our website www.apex-tools.com.

1/2" Sq. Dr. Sockets For SAE Square Nuts

Single Square & Double Square, Standard Length

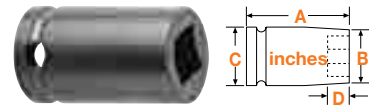

Part No. Single Square	Part No. Double Square	Square Opening In.	Overall Length (A)	Diameter Nose End (B)	Diameter Drive End (C)	Opening Depth (D)
5609	-	9/32	1 1/2	1/2	15/16	3/16
5610	5610-D	5/16	1 1/2	5/8	15/16	1/4
5612	5612-D	3/8	1 1/2	3/4	15/16	1/4
5614	5614-D	7/16	1 1/2	7/8	15/16	9/32
5616	5616-D	1/2	1 1/2	1	1	11/32
5618	5618-D	9/16	1 1/2	1 1/8	1 1/8	7/16
5620	5620-D	5/8	1 1/2	1 1/4	1 1/4	7/16
5622	-	11/16	1 1/2	1 1/4	1 1/4	7/16
5624	5624-D	3/4	1 1/2	1 3/8	1 3/8	15/32
5626	-	13/16	1 1/2	1 1/2	1 1/2	17/32
5628	-	7/8	1 1/2	1 5/8	1 5/8	5/8
5632	-	1	1 5/8	1 3/4	1 3/4	5/8
5634	-	1 1/16	1 3/4	1 7/8	1 7/8	11/16
5636	5636-D	1 1/8	1 3/4	2	2	3/4

Single Square & Double Square, Thin Wall, Standard Length

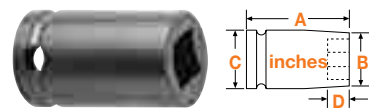

Part Number Square	Part Number Double Square	Square Opening In.	Overall Length (A)	Diameter Nose End (B)	Diameter Drive End (C)	Opening Depth (D)
5912	5912-D	3/8	1 1/2	11/16	15/16	1/4
5914	5914-D	7/16	1 1/2	25/32	15/16	9/32
5918	5918-D	9/16	1 1/2	1	1	7/16
5920	-	5/8	1 1/2	1 3/32	1 1/8	7/16

Single Square & Double Square, Long & Extra Long Length



Part Number Square	Part Number Double Square	Square Opening In.	Overall Length (A)	Diameter Nose End (B)	Diameter Drive End (C)	Opening Depth (D)
5812	-	3/8	3 1/4	3/4	15/16	1/4
5716	-	1/2	2 1/4	1	1	11/32
-	5816-D	1/2	3 1/4	1	1	7/16
5720	-	5/8	2 1/4	1 1/4	1 1/4	7/16
5820	5820-D	5/8	3 1/2	1 1/4	1 1/4	7/16
5822	5822-D	11/16	3 1/2	1 1/4	1 1/4	7/16
5724	5724-D	3/4	2 1/4	1 3/8	1 3/8	15/32
-	5826-D	13/16	3 1/2	1 1/2	1 1/2	17/32
5728	-	7/8	2 1/4	1 5/8	1 5/8	5/8
-	5832-D	1	3 1/2	1 3/4	1 3/4	5/8
-	5834-D	1 1/16	3 1/2	1 7/8	1 7/8	11/16
-	5836-D	1 1/8	3 1/2	2	2	3/4

1/2" Sq. Dr. Socket Sets, SAE



6 Point

APS58XL 8 piece, extra long length:
1/2, 9/16, 5/8, 11/16, 3/4, 13/16, 7/8, 15/16

1/2" Sq. Dr. Universal Wrenches, SAE

6 Point & Double Hex

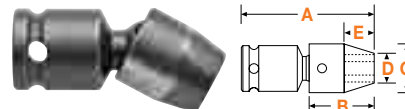

Part Number 6 Point	Part Number 12 Point	Hex Opening In.	Overall Length (A) In.	Socket Length (B) In.	Socket Diameter (C) In.	Nose End Diameter (D) In.	Clearance Depth (E) In.
SA-120	SA-120-D	5/16	1 53/64	3/4	3/4	7/16	5/16
SA-216	SA-216-D	3/8	2 11/64	7/8	7/8	9/16	11/32
SA-217	SA-217-D	7/16	2 15/64	15/16	7/8	5/8	13/32
SA-316	-	7/16	2 17/64	15/16	1	5/8	3/8
SA-218	SA-218-D	1/2	2 19/64	1	7/8	11/16	15/32
SA-317	-	1/2	2 31/64	1	1	11/16	7/16
SA-219	SA-219-D	9/16	2 23/64	1 1/16	7/8	3/4	17/32
SA-318	SA-318-D	9/16	2 29/64	1 1/8	1	3/4	9/16
SA-221	SA-221-D	5/8	2 27/64	1 1/8	7/8	7/8	19/32
SA-320	-	5/8	2 33/64	1 3/16	1	27/32	5/8
SA-402	SA-402-D	5/8	2 49/64	1 1/4	1 1/4	7/8	33/64
SA-321	SA-321-D	11/16	2 37/64	1 1/4	1	1	11/16
SA-322	SA-322-D	3/4	2 37/64	1 1/4	1 1/8	1 1/8	11/16
SA-404	SA-404-D	3/4	2 57/64	1 3/8	1 1/4	1 1/32	5/8
SA-501	-	3/4	3 1/32	1 5/8	1 1/2	1 1/8	25/32
SA-406	-	13/16	2 57/64	1 3/8	1 1/4	1 1/8	41/64
SA-407	-	7/8	2 57/64	1 3/8	1 3/16	1 5/16	41/64
SA-409	SA-409-D	15/16	2 57/64	1 3/8	1 5/16	1 5/16	41/64
SA-505	-	15/16	3 5/32	1 3/4	1 1/2	1 3/8	29/32
SA-410	-	1	2 61/64	1 7/16	1 1/2	1 1/2	45/64
SA-411	-	1 1/16	3 1/64	1 1/2	1 1/2	1 1/2	49/64
SA-508	-	1 1/8	3 9/32	1 7/8	1 5/8	1 5/8	1 1/32
SA-510	-	1 1/4	3 13/32	2	1 3/4	1 3/4	1 5/32

Universal wrenches must not be used with impact drivers. Maximum operating angle is 30°.

1/2" Sq. Dr. IronBand™ Univ. Wrenches, SAE

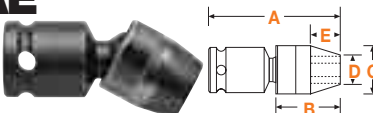

6 Point

Part Number	Hex Opening In.	Overall Length (A) In.	Socket Length (B) In.	Socket Diameter (C) In.	Nose End Diameter (D) In.	Clearance Depth (E) In.
SA-C-216	3/8	2.17	.88	.88	.56	.34
SA-C-217	7/16	2.23	.94	.88	.63	.41
SA-C-218	1/2	2.30	1.00	.88	.69	.47
SA-C-219	9/16	2.36	1.06	.88	.75	.53
SA-C-221	5/8	2.42	1.13	.88	.88	.59
SA-C-321	11/16	2.58	1.25	1.00	1.00	.69
SA-C-322	3/4	2.58	1.25	1.13	1.13	.69
SA-C-407	7/8	2.89	1.38	1.19	1.31	.64
SA-C-409	15/16	2.89	1.38	1.31	1.31	.64
SA-C-410	1	2.95	1.44	1.50	1.50	.70
SA-C-411	1 1/16	3.02	1.50	1.50	1.50	.77
SA-C-508	1 1/8	3.28	1.88	1.63	1.63	1.03
SA-C-510	1 1/4	3.41	2.00	1.75	1.75	1.16

Universal wrenches must not be used with impact drivers. Maximum operating angle is 30°.

1/2" Sq. Dr. Universal Wrench Set, SAE



6 Point

APU56 6 piece, standard length:
7/16, 1/2, 9/16, 5/8, 11/16, 3/4

Universal Wrenches 1/2" Sq. Dr., SAE - Extension

6 Point, Standard and Tension Type



Part Number Standard	Part Number Tension	Hex Opening In.	Shank Length (A) In.	Socket Length (B) In.	Socket Diameter (C) In.	Nose End Diameter (D) In.	Opening Depth (E) In.
KH-43-6	KN-43-6	3/8	6	13/16	5/8	17/32	7/16
-	KN-43-9	3/8	9	13/16	5/8	17/32	7/16
KH-44-6	KN-44-6	7/16	6	7/8	5/8	5/8	1/2
KH-45-3	-	1/2	3	7/8	11/16	11/16	1/2
KH-45-4	-	1/2	4	7/8	11/16	11/16	1/2
KH-45-6	KN-45-6	1/2	6	7/8	11/16	11/16	1/2
-	KN-45-9	1/2	9	7/8	11/16	11/16	1/2
KH-104-6	KN-104-6	1/2	6	1	3/4	3/4	9/16
-	KN-104-9	1/2	9	1	3/4	3/4	9/16
KH-202-6	KN-202-6	1/2	6	1	7/8	11/16	15/32
-	KN-202-8	1/2	9	1	7/8	11/16	15/32
KH-105-3	-	9/16	3	1	13/16	13/16	9/16
KH-105-6	KN-105-6	9/16	6	1	13/16	13/16	9/16
-	KN-105-9	9/16	9	1	13/16	13/16	9/16
KH-105-12	KN-105-12	9/16	12	1	13/16	13/16	9/16
KH-203-4	-	9/16	4	1 1/16	7/8	3/4	17/32
KH-203-6	KN-203-6	9/16	6	1 1/16	7/8	3/4	17/32
KH-203-9	KN-203-9	9/16	9	1 1/16	7/8	3/4	17/32
-	KN-203-12	9/16	12	1 1/16	7/8	3/4	17/32
-	KN-318-3	9/16	3	1 1/8	1	3/4	9/16
KH-318-4	KN-318-4	9/16	4	1 1/8	1	3/4	9/16
KH-205-3	-	5/8	3	1 1/8	7/8	7/8	19/32
KH-205-4	-	5/8	4	1 1/8	7/8	7/8	19/32
KH-205-6	KN-205-6	5/8	6	1 1/8	7/8	7/8	19/32
-	KN-205-9	5/8	9	1 1/8	7/8	7/8	19/32
KH-205-12	KN-205-12	5/8	12	1 1/8	7/8	7/8	19/32
KH-320-6	-	5/8	6	1 3/16	1	27/32	5/8
-	KN-320-12	5/8	12	1 3/16	1	27/32	5/8
KH-321-6	-	11/16	6	1 1/4	1	1	11/16
KH-322-6	KN-322-6	3/4	6	1 1/4	1 1/8	1 1/8	11/16
-	KN-322-9	3/4	9	1 1/4	1 1/8	1 1/8	11/16
-	KN-322-12	3/4	12	1 1/4	1 1/8	1 1/8	11/16
-	KN-404-6	3/4	6	1 3/8	1 1/4	1 1/32	41/64
KH-409-3	-	15/16	3	1 3/8	1 5/16	1 5/16	41/64
KH-409-4	-	15/16	4	1 3/8	1 5/16	1 5/16	41/64
KH-409-6	-	15/16	6	1 3/8	1 5/16	1 5/16	41/64
KH-409-12	-	15/16	12	1 3/8	1 5/16	1 5/16	41/64

Universal wrenches must not be used with impact drivers. Maximum operating angle is 30°. Actual design of universal wrenches may not be exactly like pictures above.

1/2" Sq. Dr. IronBand™ Univ. Wrenches, SAE - Extension

6 Point



Part Number Standard	Part Number Tension	Hex Open. In.	OA L. (A) In.	Soc. L. (B) In.	Soc. Dia. (C) In.	Nose Dia. (D) In.	Clear. Depth (E) In.
KHW-C-43-6	KNW-C-43-6	3/8	6	.81	.63	.53	.44
KHW-C-44-6	KNW-C-44-6	7/16	6	.88	.63	.63	.50
KHW-C-45-6	KNW-C-45-6	1/2	6	.88	.69	.69	.50
KHW-C-105-6	KNW-C-105-6	9/16	6	1.00	.81	.81	.56
KHW-C-105-12	KNW-C-105-12	9/16	12	1.00	.81	.81	.56
KHW-C-205-6	KNW-C-205-6	5/8	6	1.13	.88	.88	.59
KHW-C-205-12	KNW-C-205-12	5/8	12	1.13	.88	.88	.59
KHW-C-322-6	KNW-C-322-6	3/4	6	1.25	1.13	1.13	.69
-	KNW-C-322-12	3/4	12	1.25	1.13	1.13	.69
KHW-C-409-6	-	15/16	6	1.38	1.31	1.31	.64

Universal wrenches must not be used with impact drivers. Maximum operating angle is 30°.

1/2" Sq. Dr. Socket Head Bits, SAE

Complete, Adapter Only, Insert Only

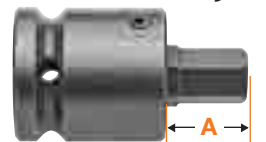

Complete	Adapter Only	Insert Only	Hex Size	Overall Length In.	mm	Length of Insert (A) In.	mm
SZ-22	SC-514	SZ-14-A	1/4	2 1/2	64	1 3/8	35
SZ-23	SC-514	SZ-15-A	5/16	2 1/2	64	1 3/8	35
SZ-24	SC-514	SZ-16-A	3/8	2 1/2	64	1 3/8	35
SZ-25	SC-514	SZ-17-A	1/2	2 1/2	64	1 3/8	35
SZ-42	SC-520	SZ-31-A	1/2	2 1/2	64	1 9/16	35
SZ-43	SC-514	SZ-18-A	9/16	2 1/2	64	1 3/8	35
SZ-44	SC-529	SZ-32-A	9/16	2 1/2	64	1 9/16	35
SZ-26	SC-514	SZ-19-A	5/8	2 1/2	64	1 3/8	35

For a complete listing, see page 19. Adapters with an "SC" prefix feature a set screw for locking in the bit. An "RP" prefix indicates adapters with a roll pin that is inserted through the bit.

1/2" Square Drive Sockets, Metric

6 Point & Double Hex, Standard Length



Part Number 6 Point	Part Number Double Hex	Hex Opening mm.	Overall Length (A)	Diameter Nose End (B)	Diameter Drive End (C)	Opening Depth (D)
10mm15	10mm15-D	10	38.1	16.7	23.8	6.4
11mm15	11mm15-D	11	38.1	17.5	23.8	7.2
12mm15	12mm15-D	12	38.1	19.1	23.8	7.2
13mm15	13mm15-D	13	38.1	22.2	23.8	8.7
14mm15	14mm15-D	14	38.1	22.2	23.8	11.1
15mm15	15mm15-D	15	38.1	23.8	23.8	11.1
16mm15	16mm15-D	16	38.1	25.4	25.4	11.1
17mm15	17mm15-D	17	38.1	28.6	28.6	11.1
18mm15	18mm15-D	18	38.1	28.6	28.6	11.1
19mm15	19mm15-D	19	38.1	28.6	28.6	11.9
20mm15	-	20	38.1	31.7	31.7	11.9
21mm15	21mm15-D	21	38.1	31.7	31.7	13.5
22mm15	22mm15-D	22	38.1	33.3	33.3	14.3
23mm15	23mm15-D	23	38.1	34.9	34.9	15.9
24mm15	24mm15-D	24	38.1	34.9	34.9	15.9
25mm15	-	25	38.1	38.1	38.1	15.9
26mm15	26mm15-D	26	38.1	38.1	38.1	15.9
27mm15	27mm15-D	27	41.3	41.3	41.3	17.5
28mm15	-	28	41.3	41.3	41.3	19.1
29mm15	29mm15-D	29	41.3	44.4	44.4	19.1
30mm15	30mm15-D	30	41.3	44.4	44.4	19.1
32mm15	32mm15-D	32	44.4	44.4	44.4	20.6
33mm15	-	33	44.4	47.6	47.6	20.6
34mm15	-	34	47.6	47.5	47.5	20.5
35mm15	-	35	47.6	50.8	50.8	20.6
36mm15	-	36	47.6	50.8	50.8	23.8

6 Point & Double Hex, Thin Wall, Standard Length

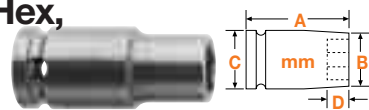

Part Number 6 Point	Part Number Double Hex	Hex Opening mm	Overall Length (A)	Diameter Nose End (B)	Diameter Drive End (C)	Opening Depth (D)
10mm45	10mm45-D	10	38.1	15.9	23.8	6.4
12mm45	12mm45-D	12	38.1	17.5	23.8	7.2
13mm45	13mm45-D	13	38.1	18.7	23.8	8.7
14mm45	14mm45-D	14	38.1	20.6	23.8	11.1
15mm45	15mm45-D	15	38.1	22.2	23.8	11.1
16mm45	16mm45-D	16	38.1	22.2	23.8	11.1
17mm45	17mm45-D	17	38.1	23.8	23.8	11.1
18mm45	18mm45-D	18	38.1	25.4	25.4	11.1
19mm45	-	19	38.1	26.3	26.3	11.9
21mm45	21mm45-D	21	38.1	28.6	28.6	13.5
22mm45	22mm45-D	22	38.1	30.2	31.7	14.3

6 Point & Double Hex, Long Length



Part Number 6 Point	Part Number Double Hex	Hex Opening mm	Overall Length (A)	Diameter Nose End (B)	Diameter Drive End (C)	Opening Depth (D)
10mm25	10mm25-D	10	57.1	16.7	23.8	6.4
11mm25	-	11	57.1	17.5	23.8	7.2
12mm25	12mm25-D	12	57.1	19.1	23.8	7.2
13mm25	13mm25-D	13	57.1	22.2	23.8	8.7
14mm25	-	14	57.1	22.2	23.8	11.1
15mm25	15mm25-D	15	57.1	23.8	23.8	11.1
16mm25	16mm25-D	16	57.1	25.4	25.4	11.1
17mm25	17mm25-D	17	57.1	28.6	28.6	11.1
18mm25	18mm25-D	18	57.1	28.6	28.6	11.1
19mm25	-	19	57.1	28.6	28.6	11.9
20mm25	20mm25-D	20	57.1	31.7	31.7	11.9
21mm25	21mm25-D	21	57.1	31.7	31.7	13.5
22mm25	22mm25-D	22	57.1	33.3	33.3	14.3
23mm25	23mm25-D	23	57.1	34.9	34.9	15.9
24mm25	24mm25-D	24	57.1	34.9	34.9	15.9
25mm25	-	25	57.1	38.1	38.1	15.9
26mm25	-	26	57.1	38.1	38.1	15.9
27mm25	-	27	60.3	41.3	41.3	17.5
28mm25	-	28	60.3	41.3	41.3	19.1
30mm25	30mm25-D	30	60.3	44.4	44.4	19.1
32mm25	-	32	63.5	44.4	44.4	20.6

6 Point & Double Hex, Extra Long Length



Part Number 6 Point	Part Number Double Hex	Hex Opening mm	Overall Length (A)	Diameter Nose End (B)	Diameter Drive End (C)	Opening Depth (D)
10mm35	10mm35-D	10	82.5	16.7	23.8	6.4
11mm35	-	11	82.5	17.5	23.8	7.2
12mm35	12mm35-D	12	82.5	19.1	23.8	7.2
13mm35	13mm35-D	13	82.5	22.2	23.8	8.7
14mm35	14mm35-D	14	82.5	22.2	23.8	11.1
15mm35	-	15	82.5	23.8	23.8	11.1
16mm35	16mm35-D	16	82.5	25.4	25.4	11.1
17mm35	17mm35-D	17	82.5	28.6	28.6	11.1
18mm35	18mm35-D	18	82.5	28.6	28.6	11.1
19mm35	19mm35-D	19	82.5	28.6	28.6	11.9
20mm35	20mm35-D	20	88.9	31.7	31.7	11.9
21mm35	21mm35-D	21	88.9	31.7	31.7	13.5
22mm35	22mm35-D	22	88.9	33.3	33.3	14.3
24mm35	24mm35-D	24	88.9	34.9	34.9	15.9
25mm35	-	25	88.9	38.1	38.1	15.9

1/2" Square Drive Sockets, Metric

6 Point & Double Hex, Thin Wall, Extra Long Length



Part Number 6 Point	Part Number Double Hex	Hex Opening mm	Overall Length (A)	Diameter Nose End (B)	Diameter Drive End (C)	Opening Depth (D)
10mm55	10mm55-D	10	82.5	15.9	23.8	6.4
11mm55	-	11	82.5	16.7	23.8	7.2
12mm55	12mm55-D	12	82.5	17.5	23.8	7.2
13mm55	13mm55-D	13	82.5	18.7	23.8	8.7
14mm55	14mm55-D	14	82.5	20.6	23.8	11.1
15mm55	15mm55-D	15	82.5	22.2	23.8	11.1
16mm55	16mm55-D	16	82.5	22.2	23.8	11.1
17mm55	17mm55-D	17	82.5	23.8	23.8	11.1
18mm55	18mm55-D	18	82.5	25.4	25.4	11.1
19mm55	-	19	82.5	26.3	26.3	11.9
21mm55	21mm55-D	21	88.9	28.6	28.6	13.5
22mm55	22mm55-D	22	88.9	30.2	31.7	14.3
24mm55	24mm55-D	24	88.9	33.3	33.3	15.9
26mm55	-	26	88.9	34.9	34.9	15.9
27mm55	27mm55-D	27	88.9	36.5	38.1	17.5
29mm55	-	29	88.9	38.1	38.1	19.1
30mm55	-	30	88.9	39.7	41.1	19.1
32mm55	-	32	88.9	42.9	42.9	20.6

Magnetic, Standard Length

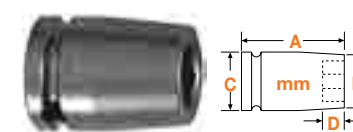

Part Number Fixed Magnet	Hex Opening mm	Overall Length (A)	Diameter Nose End (B)	Diameter Drive End (C)	Opening Depth (D)
M-10mm15	10	38.1	16.7	23.8	6.4
M-11mm15	11	38.1	17.5	23.8	7.2
M-12mm15	12	38.1	19.1	23.8	7.2
M-13mm15	13	38.1	22.2	23.8	8.7
M-14mm15	14	38.1	22.2	23.8	11.1
M-15mm15	15	38.1	23.8	23.8	11.1
M-16mm15	16	38.1	25.4	25.4	11.1
M-17mm15	17	38.1	28.6	28.6	11.1
M-18mm15	18	38.1	28.6	28.6	11.1
M-19mm15	19	38.1	28.6	28.6	11.9
M-21mm15	21	38.1	31.7	31.7	13.5

Magnetic, Thin Wall, Standard Length



Part Number Fixed Magnet	Hex Opening mm	Overall Length (A)	Diameter Nose End (B)	Diameter Drive End (C)	Opening Depth (D)
M-13mm45	13	38.1	18.7	23.8	8.7
M-14mm45	14	38.1	20.6	23.8	11.1
M-15mm45	15	38.1	22.2	23.8	11.1

Magnetic, Long Length



Part No. Fixed Magnet	Part No. Magnetic Bolt Clearance	Hex Opening mm	Overall Length (A)	Diameter Nose End (B)	Diameter Drive End (C)	Opening Depth (D)
-	MB-10mm25	10	57.1	16.7	23.8	6.4
-	MB-12mm25	12	57.1	19.1	23.8	7.2
M-13mm25	MB-13mm25	13	57.1	22.2	23.8	8.7
-	MB-14mm25	14	57.1	22.2	23.8	11.1
M-15mm25	MB-15mm25	15	57.1	23.8	23.8	11.1
-	MB-16mm25	16	57.1	25.4	25.4	11.1
M-18mm25	MB-18mm25	18	57.1	28.6	28.6	11.1

Magnetic, Extra Long Length



Part No. Fixed Magnet	Part No. Magnetic Bolt Clearance	Hex Opening mm	Overall Length (A)	Diameter Nose End (B)	Diameter Drive End (C)	Opening Depth (D)
M-13mm35	-	13	82.5	22.2	23.8	8.7
M-13mm55*	-	13	82.5	18.7	23.8	8.7
M-15mm35	MB-15mm35	15	82.5	23.8	23.8	11.1
M-18mm35	MB-18mm35	18	82.5	28.6	28.6	11.1
M-18mm55*	-	18	82.5	25.4	25.4	11.1

*Thin Wall

1/2" Square Drive Sockets, Metric

Surface Drive, Standard Length



Part Number Surface Drive	Hex Opening mm	Overall Length (A)	Diameter Nose End (B)	Diameter Drive End (C)	Opening Depth (D)
SF-10mm15	10	38.1	16.7	23.8	6.4
SF-11mm15	11	38.1	17.5	23.8	7.2
SF-12mm15	12	38.1	19.1	23.8	7.2
SF-13mm15	13	38.1	22.2	23.8	8.7
SF-14mm15	14	38.1	22.2	23.8	11.1
SF-15mm15	15	38.1	23.8	23.8	11.1
SF-16mm15	16	38.1	25.4	25.4	11.1
SF-17mm15	17	38.1	28.6	28.6	11.1
SF-18mm15	18	38.1	28.6	28.6	11.1
SF-19mm15	19	38.1	28.6	28.6	11.9
SF-20mm15	20	38.1	31.7	31.7	11.9
SF-21mm15	21	38.1	31.7	31.7	13.5
SF-22mm15	22	38.1	33.3	33.3	14.3
SF-23mm15	23	38.1	34.9	34.9	15.9
SF-24mm15	24	38.1	34.9	34.9	15.9

Surface Drive, Thin Wall, Standard Length

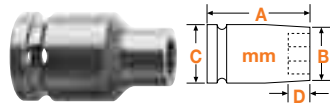

Part Number Surface Drive	Hex Opening mm	Overall Length (A)	Diameter Nose End (B)	Diameter Drive End (C)	Opening Depth (D)
SF-10mm45	10	38.1	15.9	23.8	6.4
SF-11mm45	11	38.1	16.7	23.8	7.2
SF-12mm45	12	38.1	17.5	23.8	7.2
SF-13mm45	13	38.1	18.7	23.8	8.7
SF-14mm45	14	38.1	20.6	23.8	11.1
SF-15mm45	15	38.1	22.2	23.8	11.1
SF-16mm45	16	38.1	22.2	23.8	11.1
SF-17mm45	17	38.1	23.8	23.8	11.1
SF-18mm45	18	38.1	25.4	25.4	11.1
SF-19mm45	19	38.1	26.3	26.3	11.9
SF-21mm45	21	38.1	28.6	28.6	11.9

Surface Drive, Long Length

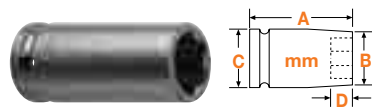

Part Number Surface Drive	Hex Opening mm	Overall Length (A)	Diameter Nose End (B)	Diameter Drive End (C)	Opening Depth (D)
SF-10mm25	10	57.1	16.7	23.8	6.4
SF-11mm25	11	57.1	17.5	23.8	7.2
SF-12mm25	12	57.1	19.1	23.8	7.2
SF-13mm25	13	57.1	22.2	23.8	7.2
SF-14mm25	14	57.1	22.2	23.8	11.1
SF-15mm25	15	57.1	23.8	23.8	11.1
SF-16mm25	16	57.1	25.4	25.4	11.1
SF-17mm25	17	57.1	28.6	28.6	11.1
SF-18mm25	18	57.1	28.6	28.6	11.1
SF-19mm25	19	57.1	28.6	28.6	11.9
SF-21mm25	21	57.1	31.7	31.7	13.5
SF-22mm25	22	57.1	33.3	33.3	14.3
SF-24mm25	24	57.1	34.9	34.9	15.9

Surface Drive, Extra Long Length



Part Number Surface Drive	Hex Opening mm	Overall Length (A)	Diameter Nose End (B)	Diameter Drive End (C)	Opening Depth (D)
SF-10mm35	10	82.5	16.7	23.8	6.4
SF-12mm35	12	82.5	17.5	23.8	7.2
SF-13mm35	13	82.5	19.1	23.8	7.2
SF-14mm35	14	82.5	22.2	23.8	11.1
SF-15mm35	15	82.5	23.8	23.8	11.1
SF-16mm35	16	82.5	25.4	25.4	11.1
SF-17mm35	17	82.5	28.6	28.6	11.1
SF-18mm35	18	82.5	28.6	28.6	11.1
SF-19mm35	19	82.5	28.6	28.6	11.9
SF-21mm35	21	88.9	31.7	31.7	13.5
SF-22mm35	22	88.9	33.3	33.3	14.3
SF-24mm35	24	88.9	34.9	34.9	15.9

Surface Drive, Thin Wall, Extra Long Length



Part Number Surface Drive	Hex Opening mm	Overall Length (A)	Diameter Nose End (B)	Diameter Drive End (C)	Opening Depth (D)
SF-10mm55	10	82.5	15.9	23.8	6.4
SF-11mm55	11	82.5	16.7	23.8	7.2
SF-13mm55	13	82.5	18.7	23.8	8.7
SF-14mm55	14	82.5	20.6	23.8	11.1
SF-15mm55	15	82.5	22.2	23.8	11.1
SF-16mm55	16	82.5	22.2	23.8	11.1
SF-17mm55	17	82.5	23.8	23.8	11.1
SF-18mm55	18	82.5	25.4	25.4	11.1
SF-19mm55	19	82.5	26.3	26.3	11.9
SF-21mm55	21	88.9	28.6	28.6	13.5
SF-22mm55	22	88.9	30.2	31.7	15.9

1/2" Sq. Dr. Sockets For Metric Sheet Metal Screws

6 Point & 6 Point Magnetic, For Regular Screws

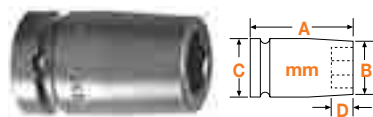

Part Number 6 Point	Part Number Magnetic	Hex Opening mm.	Overall Length (A)	Diameter Nose End (B)	Diameter Drive End (C)	Opening Depth (D)
-	M-13mmE5	13	38.1	22.2	23.8	8.7
15mmE5	M-15mmE5	15	38.1	23.8	23.8	11.1

1/2" Sq. Dr. Socket Sets, Metric

6 Point



APS511M 11 piece, standard length:
10mm, 11mm, 12mm, 13mm, 14mm, 15mm, 16mm, 17mm,
18mm, 19mm, 21mm

1/2" Sq. Dr. Universal Wrenches, Metric

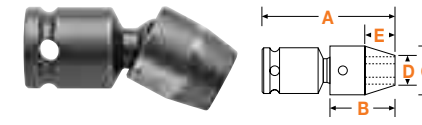

6 Point

Part Number 6 Point	Hex Opening mm	Overall Length (A) mm	Socket Length (B) mm	Socket Diameter (C) mm	Nose End Diameter (D) mm	Clearance Depth (E) mm
SA-57-13m	13	58	25.4	22.2	17.5	11.9
SA-57-14m	14	60	27.0	22.2	19.1	13.5
SA-58-15m	15	62	28.6	25.4	19.8	14.3
SA-58-16m	16	64	30.2	25.4	21.4	15.9
SA-58-17m	17	66	31.8	25.4	25.4	17.5
SA-58-18m	18	66	31.8	25.4	25.4	17.5
SA-510-19m	19	73	34.9	31.8	26.2	16.3
SA-510-20m	20	73	34.9	31.8	27.0	16.3
SA-510-21m	21	73	34.9	31.8	28.6	16.3
SA-510-22m	22	73	34.9	31.8	31.8	16.3
SA-510-24m	24	73	34.9	31.8	34.9	16.3

1/2" Sq. Dr. IronBand™ Univ. Wrenches, Metric

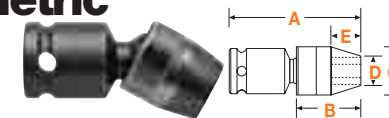

6 Point

Part Number	Hex Opening mm	Overall Length (A) mm	Socket Length (B) mm	Socket Diameter (C) mm	Nose End Diameter (D) mm	Clearance Depth (E) mm
SA-C-57-13M	13	58	25.4	22.2	17.5	11.9
SA-C-57-14M	14	60	27.0	22.2	19.1	13.5
SA-C-58-15M	15	62	28.6	25.4	19.8	14.3
SA-C-58-16M	16	64	30.2	25.4	21.4	15.9
SA-C-58-17M	17	66	31.8	25.4	25.4	17.5
SA-C-58-18M	18	66	31.8	25.4	25.4	17.5
SA-C-510-21M	21	73	34.9	31.8	28.6	16.3
SA-C-510-22M	22	73	34.9	31.8	31.8	16.3

Universal wrenches must not be used with impact drivers. Maximum operating angle is 30°.

1/2" Sq. Dr. Universal Wrench Set, Metric



6 Point

APU56M 6 piece, standard length:
13mm, 14mm, 15mm,
16mm, 17mm, 18mm

1/2" Sq. Dr. Universal Wrenches, Metric - Extension

6 Point, Standard and Tension Type



Part Number Standard	Part Number Tension	Hex Opening mm	Shank Length (A) mm	Socket Length (B) mm	Socket Diameter (C) mm	Nose End Diameter (D) mm	Clearance Depth (E) mm
-	KN-7-12m-6	12	152	23.8	22.2	17.5	10.3
-	KN-7-12m-9	12	229	23.8	22.2	17.5	10.3
KH-7-13m-3	-	13	76	25.4	22.2	17.5	11.9
KH-7-13m-4	-	13	102	25.4	22.2	17.5	11.9
KH-7-13m-6	KN-7-13m-6	13	152	25.4	22.2	17.5	11.9
KH-7-13m-9	KN-7-13m-9	13	229	25.4	22.2	17.5	11.9
-	KN-7-13m-12	13	305	25.4	22.2	17.5	11.9
KH-7-14m-6	KN-7-14m-6	14	152	27.0	22.2	19.1	13.5
-	KN-7-14m-9	14	229	27.0	22.2	19.1	13.5
KH-8-15m-3	-	15	76	28.6	25.4	19.8	14.3
KH-8-15m-6	KN-8-15m-6	15	152	28.6	25.4	19.8	14.3
KH-8-15m-9	KN-8-15m-9	15	229	28.6	25.4	19.8	14.3
-	KN-8-15m-12	15	305	28.6	25.4	19.8	14.3
KH-8-16m-3	-	16	76	30.2	25.4	21.4	15.9
KH-8-16m-4	-	16	102	30.2	25.4	21.4	15.9
KH-8-16m-9	KN-8-16m-9	16	229	30.2	25.4	21.4	15.9
KH-8-16m-12	KN-8-16m-12	16	305	30.2	25.4	21.4	15.9
KH-8-17m-3	-	17	76	31.8	25.4	25.4	17.5
KH-8-17m-4	-	17	102	31.8	25.4	25.4	17.5
KH-8-17m-6	KN-8-17m-6	17	152	31.8	25.4	25.4	17.5
KH-8-17m-9	KN-8-17m-9	17	229	31.8	25.4	25.4	17.5
KH-8-18m-3	-	18	76	31.8	25.4	25.4	17.5
KH-8-18m-4	-	18	102	31.8	25.4	25.4	17.5
KH-8-18m-6	KN-8-18m-6	18	152	31.8	25.4	25.4	17.5
KH-8-18m-9	KN-8-18m-9	18	229	31.8	25.4	25.4	17.5
-	KN-8-18m-12	18	305	31.8	25.4	25.4	17.5
KH-10-19m-3	-	19	76	34.9	31.8	26.2	16.3
KH-10-19m-6	-	19	152	34.9	31.8	26.2	16.3
KH-10-19m-9	-	19	229	34.9	31.8	26.2	16.3
KH-10-19m-12	-	19	305	34.9	31.8	26.2	16.3

Universal wrenches must not be used with impact drivers. Maximum operating angle is 30°.

1/2" Sq. Dr. IronBand™ Univ. Wrenches, Metric - Extension

6 Point



Part Number Standard	Part Number Tension	Hex Open. mm	OA L. (A) mm	Soc. L. (B) mm	Soc. Dia. (C) mm	Nose Dia. (D) mm	Clear. Depth (E) mm
KHW-C-7-13m-6	KNW-C-7-13m-6	13	152	25.4	22.2	17.5	11.9
KHW-C-7-13m-9	KNW-C-7-13m-9	13	229	25.4	22.2	17.5	11.9
KHW-C-7-14m-6	KNW-C-7-14m-6	14	152	27.0	22.2	19.1	13.5
KHW-C-8-15m-6	KNW-C-8-15m-6	15	152	28.6	25.4	19.8	14.3
KHW-C-8-15m-9	-	15	229	28.6	25.4	19.8	14.3
-	KNW-C-8-15m-12	15	305	28.6	25.4	19.8	14.3
KHW-C-8-16m-9	KNW-C-8-16m-9	16	229	30.2	25.4	21.4	15.9
KHW-C-8-17m-6	KNW-C-8-17m-6	17	152	31.8	25.4	25.4	17.5
KHW-C-8-17m-9	KNW-C-8-17m-9	17	229	31.8	25.4	25.4	17.5
KHW-C-8-18m-6	KNW-C-8-18m-6	18	152	31.8	25.4	25.4	17.5
KHW-C-8-18m-9	KNW-C-8-18m-9	18	229	31.8	25.4	25.4	17.5

Universal wrenches must not be used with impact drivers. Maximum operating angle is 30°.

1/2" Sq. Dr. Socket Head Bits, Metric

Complete, Adapter Only, Insert Only

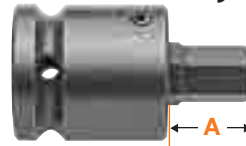

Part Number	Adapter Only	Insert Only	Hex Size	Overall Length In.	Overall Length mm	Length of Insert (A) In.	Length of Insert (A) mm
SZ-5-7-8mm	SC-514	SZ-7-8mm	8mm	2 1/2	64	1 3/8	35
SZ-5-7-10mm	SC-514	SZ-7-10mm	10mm	2 1/2	64	1 3/8	35
SZ-5-7-12mm	SC-514	SZ-7-12mm	12mm	2 1/2	64	1 3/8	35
SZ-5-7-14mm	SC-514	SZ-7-14mm	14mm	2 1/2	64	1 3/8	35
SZ-5-10-14mm	RP-520	SZ-10-14mm	14mm	2 1/2	64	1 9/16	40
SZ-5-10-17mm	RP-520	SZ-10-17mm	17mm	2 1/2	64	1 9/16	40

For a complete listing, see page 20.

1/2" Sq. Dr. Sockets For Spline Fasteners

Standard & Long Length



Part Number	Spline Size	Nominal Size	Overall Length (A) In.	Overall Length (A) mm	Diameter Nose End (B) In.	Diameter Nose End (B) mm	Diameter Drive End (C) In.	Diameter Drive End (C) mm
CMS-5416	16	1/2	1 1/4	32	23/32	18	7/8	22
CMS-5422	22	11/16	1 1/2	38	31/32	25	31/32	25
CMS-5426	26	13/16	1 1/2	38	1 1/8	29	1 1/8	29
CMS-5430	30	15/16	1 1/2	38	1 1/4	32	1 1/4	32

Apex spline sockets conform to military specifications MS-37787 and MIL-W-8982C.

1/2" Sq. Dr. Torx® Sockets

For External Torx Screws



Part Number	Driver Size	Overall Length (A) In.	Overall Length (A) mm	Diameter Nose End (B) In.	Diameter Nose End (B) mm	Diameter Drive End (C) In.	Diameter Drive End (C) mm
TX-5110	E-10	1 1/2	38	9/16	13	1	25
TX-5112	E-12	1 1/2	38	5/8	16	1	25
TX-5114	E-14	1 1/2	38	11/16	18	1	25
TX-5116	E-16	1 1/2	38	13/16	21	1	25
TX-5118	E-18	1 1/2	38	7/8	22	1	25
TX-5120	E-20	1 1/2	38	1	25	1 3/16	30
TX-5124	E-24	1 1/2	38	1 5/16	33	1 5/16	33

For External Torx Screws, Thin Wall



Part Number	Driver Size	Overall Length (A) In.	Overall Length (A) mm	Diameter Nose End (B) In.	Diameter Nose End (B) mm	Diameter Drive End (C) In.	Diameter Drive End (C) mm
TX-5408	E-8	1 1/2	38	3/8	10	7/8	22
TX-5410	E-10	1 1/2	38	1/2	13	7/8	22
TX-5412	E-12	1 1/2	38	9/16	14	7/8	22
TX-5414	E-14	1 1/2	38	5/8	16	7/8	22
TX-5416	E-16	1 1/2	38	7/8	22	7/8	22
TX-5418	E-18	1 1/2	38	15/16	24	15/16	24
TX-5420	E-20	1 1/2	38	1 1/16	27	1 1/16	27

1/2" Sq. Dr. Extensions

1 23/32" to 18" (44mm to 457mm) Length



Part Number	Male Square In.	Type of Lock	Overall Length In.	Overall Length mm
EX-504	1/2	Pin	1 23/32	44
EX-504-B	1/2	Ball	1 23/32	44
EX-508-2	1/2	Pin	2	51
EX-508-B-2	1/2	Ball	2	51
EX-508-3	1/2	Pin	3	76
EX-508-B-3	1/2	Ball	3	76
EX-508-4	1/2	Pin	4	102
EX-508-B-4	1/2	Ball	4	102
EX-508-5	1/2	Pin	5	127
EX-508-B-5	1/2	Ball	5	127
EX-508-6	1/2	Pin	6	152
EX-508-B-6	1/2	Ball	6	152
EX-508-8	1/2	Pin	8	203
EX-508-B-8	1/2	Ball	8	203
EX-508-9	1/2	Pin	9	229
EX-508-B-9	1/2	Ball	9	229
EX-508-10	1/2	Pin	10	254
EX-508-B-10	1/2	Ball	10	254
EX-508-12	1/2	Pin	12	305
EX-508-B-12	1/2	Ball	12	305
EX-508-15	1/2	Pin	15	381
EX-508-B-15	1/2	Ball	15	381
EX-508-16	1/2	Pin	16	406
EX-508-18	1/2	Pin	18	457

1/2" Sq. Dr. Adapters

1/4" to 5/8" Male Square



Part Number	Male Square In.	Female Square In.	Type of Lock	Overall Length In.	Overall Length mm
EX-260	1/4	1/2	Pin	1 1/2	38
EX-260-B	1/4	1/2	Ball	1 1/2	38
EX-258-B-2	1/4	1/2	Ball	2	51
EX-258-4	1/4	1/2	Pin	4	102
EX-375	3/8	1/2	Pin	1 1/2	38
EX-375-B	3/8	1/2	Ball	1 1/2	38
EX-377-2	3/8	1/2	Pin	2	51
EX-377-B-2	3/8	1/2	Ball	2	51
EX-377-3	3/8	1/2	Pin	3	76
EX-377-B-3	3/8	1/2	Ball	3	76
EX-377-4	3/8	1/2	Pin	4	102
EX-377-B-4	3/8	1/2	Ball	4	102
EX-377-5	3/8	1/2	Pin	5	127
EX-377-B-5	3/8	1/2	Ball	5	127
EX-377-6	3/8	1/2	Pin	6	152
EX-377-B-6	3/8	1/2	Ball	6	152
EX-377-8	3/8	1/2	Pin	8	203
EX-377-B-9	3/8	1/2	Ball	9	229
EX-377-10	3/8	1/2	Pin	10	254
EX-377-B-10	3/8	1/2	Ball	10	254
EX-377-12	3/8	1/2	Pin	12	305
EX-377-B-12	3/8	1/2	Ball	12	305
EX-377-15	3/8	1/2	Pin	15	381

1/2" Sq. Dr. Adapters

5/8" to 3/4" Male Square



Part Number	Male Square In.	Female Square In.	Type of Lock	Overall Length In.	Overall Length mm
EX-623	5/8	1/2	Pin	1 1/2	38
EX-623-B	5/8	1/2	Ball	1 1/2	38
EX-626-3	5/8	1/2	Pin	3	76
EX-751	3/4	1/2	7/32 drill hole	1 13/16	46
EX-751-B	3/4	1/2	Ball	1 13/16	46

1/2" Sq. Dr. Universal Adapters

3/8" to 3/4" Male Square



Part Number	Male Sq. In.	Female Sq. In.	Type of Lock	Overall Length In.	Overall Length mm	Largest Diameter in.	Largest Diameter mm
MF-39	3/8	1/2	Pin	2 9/16	65	7/8	22
MF-39B	3/8	1/2	Ball	2 9/16	65	7/8	22
MF-50	1/2	1/2	Pin	2 11/16	68	1	25
MF-50B	1/2	1/2	Ball	2 11/16	68	1	25
MF-55	1/2	1/2	Pin	3 1/16	78	1 1/4	32
MF-55B	1/2	1/2	Ball	3 1/16	78	1 1/4	32
MF-70	3/4	1/2	7/32 drill hole	3 5/8	92	1 1/2	38
MF-70B	3/4	1/2	Ball	3 5/8	92	1 1/2	38

Universal wrenches must not be used with impact drivers. Maximum operating angle is 30°.

1/2" Sq. Dr. Universal Adapters - Extension



(Standard Type Shown)

1/2" Male Square

Part Number	Male Sq. In.	Female Sq. In.	Type of Lock	Largest Dia. In.	Largest Dia. mm
KHM-37-6	3/8	1/2	Pin	3/4	19
KNM-37-6	3/8	1/2	Pin	3/4	19
KHM-38-6	3/8	1/2	Pin	7/8	22
KNM-38-6	3/8	1/2	Pin	7/8	22
KHM-50-6	1/2	1/2	Pin	1	25
KNM-50-6	1/2	1/2	Pin	1	25
KHM-50-B-6	1/2	1/2	Ball	1	25
KNM-50-B-6	1/2	1/2	Ball	1	25

Universal wrenches must not be used with impact drivers. Maximum operating angle is 30°. Standard lengths are 3", 6", 9" and 12" (76, 152, 229 and 305mm).

If the tool you need does not appear in this catalog, give us a call. The odds are, we may have what you need as a non-catalog item. If not, our experienced staff of tooling experts can design and manufacture "specials" to meet the needs of your specific application. Give us a call at 1-800-845-5629 or visit our website www.apex-tools.com.

5/8" Square Drive Sockets, SAE

6 Point & Double Hex, Standard Length

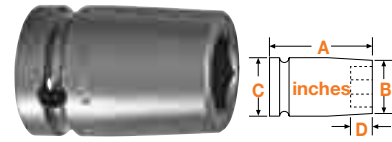

Part Number 6 Point	Part Number Double Hex	Hex Opening In.	Overall Length (A)	Diameter Nose End (B)	Diameter Drive End (C)	Opening Depth (D)
6118	-	9/16	1 7/8	7/8	1 1/4	7/16
6120	6120-D	5/8	1 7/8	1	1 1/4	7/16
6122	-	11/16	1 7/8	1 1/8	1 1/4	7/16
6124	-	3/4	1 7/8	1 1/4	1 1/4	15/32
6128	-	7/8	1 7/8	1 3/8	1 3/8	9/16
6134	-	1 1/16	2	1 5/8	1 5/8	11/16
6136	-	1 1/8	2	1 5/8	1 5/8	3/4
6140	-	1 1/4	2	1 7/8	1 7/8	13/16
6142	-	1 5/16	2	2	2	13/16
6144	-	1 3/8	2 1/8	2	2	13/16
6146	-	1 7/16	2 1/8	2 1/8	2 1/8	15/16
6148	-	1 1/2	2 1/4	2 1/8	2 1/8	1

6 Point & Double Hex, Thin Wall Standard Length



Part Number 6 Point	Hex Opening In.	Overall Length (A)	Diameter Nose End (B)	Diameter Drive End (C)	Opening Depth (D)
6426	13/16	1 7/8	1 1/8	1 1/4	17/32
6430	15/16	2	1 5/16	1 5/16	5/8

6 Point & Double Hex, Extra Long Length



Part Number 6 Point	Hex Opening In.	Overall Length (A)	Diameter Nose End (B)	Diameter Drive End (C)	Opening Depth (D)
6320	5/8	3 1/2	1	1 1/4	7/16
6322	11/16	3 1/2	1 1/8	1 1/4	7/16
6324	3/4	3 1/2	1 1/4	1 1/4	15/32
6326	13/16	3 1/2	1 1/4	1 1/4	17/32
6330	15/16	3 1/2	1 1/2	1 1/2	5/8
6336	1 1/8	3 1/2	1 5/8	1 5/8	3/4
6340	1 1/4	3 1/2	1 7/8	1 7/8	13/16
6342	1 5/16	3 1/2	2	2	13/16
6344	1 3/8	3 1/2	2	2	13/16
6348	1 1/2	3 1/2	2 1/8	2 1/8	1

6 Point & Double Hex, Thin Wall, Extra Long Length



Part Number 6 Point	Part Number Double Hex	Hex Opening In.	Overall Length (A)	Diameter Nose End (B)	Diameter Drive End (C)	Opening Depth (D)
-	6520-D	5/8	3 1/2	15/16	1 1/4	7/16
6524	6524-D	3/4	3 1/2	1 1/16	1 1/4	15/32
-	6528-D	7/8	3 1/2	1 3/16	1 1/4	9/16

Surface Drive & Fast Lead, Standard Length



Part No. Surface Drive	Part No. Fast Lead	Hex Opening In.	Overall Length (A)	Diameter Nose End (B)	Diameter Drive End (C)	Opening Depth (D)
SF-6118	-	9/16	1 7/8	7/8	1 1/4	7/16
SF-6120	-	5/8	1 7/8	1	1 1/4	7/16
SF-6124	FL-6124	3/4	1 7/8	1 1/4	1 1/4	15/32
SF-6424*	-	3/4	1 7/8	1 1/16	1 1/4	15/32
SF-6128	FL-6128	7/8	1 7/8	1 3/8	1 3/8	9/16

*Thin Wall

Surface Drive & Fast Lead, Thin Wall, Extra Long Length



Part No. Surface Drive	Part No. Fast Lead	Hex Opening In.	Overall Length (A)	Diameter Nose End (B)	Diameter Drive End (C)	Opening Depth (D)
SF-6320	-	5/8	3 1/2	1	1 1/4	7/16
SF-6324	FL-6324	3/4	3 1/2	1 1/4	1 1/4	15/32
SF-6524*	-	3/4	3 1/2	1 1/16	1 1/4	15/32
SF-6326	-	13/16	3 1/2	1 1/4	1 1/4	17/32
SF-6328	-	7/8	3 1/2	1 3/8	1 3/8	9/16
SF-6330	-	15/16	3 1/2	1 1/2	1 1/2	5/8

*Thin Wall

5/8" Sq. Dr. Sockets, Metric

6 Point & Surface Drive, Standard Length



Part Number 6 Point	Part No. Surface Drive	Hex Opening mm	Overall Length (A)	Diameter Nose End (B)	Diameter Drive End (C)	Opening Depth (D)
-	SF-15mm16	15	48	23.8	31.8	11.1
16mm16	SF-16mm16	16	48	25.4	31.8	11.1
17mm16	SF-17mm16	17	48	28.6	31.8	11.1
18mm16	SF-18mm16	18	48	28.5	31.8	11.1
-	SF-19mm16	19	48	31.8	31.8	11.9
21mm16	SF-21mm16	21	48	31.8	31.8	13.5
-	SF-22mm16	22	48	34.9	34.9	14.3
24mm16	SF-24mm16	24	51	38.1	38.1	15.9

6 Point & Surface Drive, Extra Long Length



Part Number 6 Point	Part No. Surface Drive	Hex Opening mm	Overall Length (A)	Diameter Nose End (B)	Diameter Drive End (C)	Opening Depth (D)
-	SF-15mm36	15	89	23.8	31.8	11.1
17mm36	-	17	89	25.4	31.8	11.1
-	SF-18mm36	18	89	28.6	31.8	11.1
19mm36	SF-19mm36	19	89	31.8	31.8	11.9
21mm36	SF-21mm36	21	89	31.8	31.8	13.5
-	SF-22mm36	22	89	34.9	34.9	14.3
24mm36	SF-24mm36	24	89	38.1	38.1	15.9

5/8" Sq. Dr. Extensions

1 7/8" to 15" (48mm to 381mm) Length



Part Number	Male Square In.	Type of Lock	Overall Length In.	Overall Length mm
EX-624	5/8	Pin	1 7/8	48
EX-624-B	5/8	Ball	1 7/8	48
EX-627-3	5/8	Pin	3	76
EX-627-4	5/8	Pin	4	102
EX-627-6	5/8	Pin	6	152
EX-627-8	5/8	Pin	8	203
EX-627-10	5/8	Pin	10	254
EX-627-12	5/8	Pin	12	305

5/8" Sq. Dr. Adapters



1/2" to 3/4" Male Square

Part Number	Male Square In.	Female Square In.	Type of Lock	Overall Length In.	Overall Length mm
EX-505	1/2	5/8	Pin	1 7/8	48
EX-505-B	1/2	5/8	Ball	1 7/8	48
EX-509-3	1/2	5/8	Pin	3	76
EX-509-4	1/2	5/8	Pin	4	102
EX-509-5	1/2	5/8	Pin	5	127
EX-509-6	1/2	5/8	Pin	6	152
EX-509-10	1/2	5/8	Pin	10	254
EX-509-12	1/2	5/8	Pin	12	305
EX-752	3/4	5/8	7/32 Drill Hole	1 7/8	48
EX-752-B	3/4	5/8	Ball	1 7/8	48

5/8" Sq. Dr. Universal Adapters



1/2" to 5/8" Male Square

Part Number	Male Square In.	Female Square In.	Type of Lock	Overall Length In.	Overall Length mm	Largest Diameter in.	Largest Diameter mm
MF-51	1/2	5/8	Pin	3 5/16	84	1 1/4	32
MF-62	5/8	5/8	Pin	3 1/4	83	1 1/4	32
MF-62B	5/8	5/8	Ball	3 1/4	83	1 1/4	32

Universal wrenches must not be used with impact drivers.
Maximum operating angle is 30°.-

3/4" Square Drive Sockets, SAE

6 Point & Double Hex, Standard Length

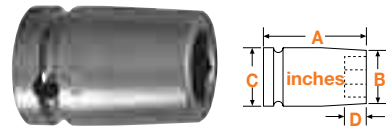

Part Number 6 Point	Part Number Double Hex	Hex Opening In.	Overall Length (A)	Diameter Nose End (B)	Diameter Drive End (C)	Opening Depth (D)
7120	7120-D	5/8	2	1 1/16	1 1/2	7/16
7122	7122-D	11/16	2	1 1/8	1 1/2	7/16
7124	7124-D	3/4	2	1 1/4	1 1/2	15/32
7128	7128-D	7/8	2	1 1/2	1 1/2	9/16
7130	7130-D	15/16	2	1 1/2	1 1/2	5/8
7132	7132-D	1	2	1 5/8	1 5/8	5/8
7134	7134-D	1 1/16	2	1 3/4	1 3/4	11/16
7136	7136-D	1 1/8	2 1/8	1 3/4	1 3/4	3/4
7140	7140-D	1 1/4	2 1/8	2	1 3/4	13/16
7142	7142-D	1 5/16	2 1/8	2	1 3/4	13/16
7144	-	1 3/8	2 1/8	2 1/8	2 1/8	13/16
7146	-	1 7/16	2 1/4	2 1/4	2 1/8	15/16
7148	7148-D	1 1/2	2 1/4	2 1/4	2 1/8	1
7152	7152-D	1 5/8	2 1/4	2 1/2	2 1/8	1 1/8
7154	7154-D	1 11/16	2 1/4	2 1/2	2 1/8	1 1/8
7156	-	1 3/4	2 1/4	2 5/8	2 1/8	1 1/8
7158	-	1 13/16	2 1/4	2 3/4	2 1/8	1 1/4
7160	7160-D	1 7/8	2 1/4	2 3/4	2 1/8	1 1/4
7164	7164-D	2	2 3/8	2 7/8	2 1/8	1 3/8
7168	-	2 1/8	2 3/8	3 1/8	2 1/8	1 3/8
7170	7170-D	2 3/16	2 1/2	3 1/8	2 1/8	1 1/2
7172	7172-D	2 1/4	2 1/2	3 1/4	2 1/8	1 1/2
7176	-	2 3/8	2 5/8	3 1/2	2 1/8	1 5/8
7180	7180-D	2 1/2	2 5/8	3 1/2	2 1/8	1 5/8

6 Point & Double Hex, Thin Wall Standard Length



Part Number 6 Point	Part Number Double Hex	Hex Opening In.	Overall Length (A)	Diameter Nose End (B)	Diameter Drive End (C)	Opening Depth (D)
7424	7424-D	3/4	2	1 1/8	1 3/8	15/32
7426	-	13/16	2	1 1/4	1 3/8	17/32
7428	7428-D	7/8	2	1 5/16	1 3/8	9/16
7430	7430-D	15/16	2	1 3/8	1 3/8	5/8
7432	-	1	2	1 7/16	1 7/16	5/8
7434	-	1 1/16	2	1 1/2	1 1/2	11/16
7436	-	1 1/8	2 1/8	1 5/8	1 5/8	3/4
7438	-	1 3/16	2 1/8	1 5/8	1 5/8	3/4
7442	7442-D	1 5/16	2 1/8	1 7/8	1 3/4	13/16
7446	-	1 7/16	2 1/4	2	1 3/4	15/16
7448	-	1 1/2	2 1/4	2 1/8	2 1/8	1
7454	-	1 11/16	2 1/4	2 3/8	2 1/8	1 1/8
7456	-	1 3/4	2 1/4	2 7/16	2 1/8	1 1/8

6 Point & Double Hex, Extra Long Length



Part Number 6 Point	Part Number Double Hex	Hex Opening In.	Overall Length (A)	Diameter Nose End (B)	Diameter Drive End (C)	Opening Depth (D)
7324SKT	7324-D	3/4	4	1 1/4	1 1/2	15/32
7328	-	7/8	4	1 7/16	1 1/2	9/16
7330	7330-D	15/16	4	1 1/2	1 1/2	5/8
7332	7332-D	1	4	1 1/2	1 1/2	5/8
7334	-	1 1/16	4	1 5/8	1 5/8	11/16
7336	7336-D	1 1/8	4	1 3/4	1 3/4	3/4
7340	-	1 1/4	4	1 7/8	1 3/4	13/16
7342	-	1 5/16	4	2	1 3/4	13/16
7346	-	1 7/16	4	2 1/8	2 1/8	15/16
7348	-	1 1/2	4	2 1/4	2 1/8	1
7352	-	1 5/8	4	2 1/2	2 1/8	1 1/8
7356	-	1 3/4	4	2 5/8	2 1/8	1 1/8
7358	-	1 13/16	4	2 3/4	2 1/8	1 1/4
7360	-	1 7/8	4	2 3/4	2 1/8	1 1/4
7362	-	1 15/16	4	2 3/4	2 1/8	1 1/4
7364	-	2	4 1/8	2 7/8	2 1/8	1 3/8
7372	-	2 1/4	4 1/4	3 1/4	2 1/8	1 1/2

6 Point & Double Hex, Thin Wall, Extra Long Length



Part Number 6 Point	Part Number Double Hex	Hex Opening In.	Overall Length (A)	Diameter Nose End (B)	Diameter Drive End (C)	Opening Depth (D)
7524	-	3/4	4	1 1/8	1 3/8	15/32
7528	-	7/8	4	1 3/8	1 3/8	9/16
7530	7530-D	15/16	4	1 3/8	1 3/8	5/8
7536	7536-D	1 1/8	4	1 5/8	1 5/8	3/4
7540	-	1 1/4	4	1 3/4	1 3/4	13/16
7542	-	1 5/16	4	1 7/8	1 3/4	13/16
7548	-	1 1/2	4	2 1/8	2 1/8	1
7552	-	1 5/8	4	2 1/4	2 1/8	1 1/8
7556	-	1 3/4	4	2 1/2	2 1/8	1 1/8

3/4" Square Drive Sockets For SAE Square Nuts

Single Square & Double Square, Standard Length



Part No. Single Square	Square Opening In.	Overall Length (A)	Diameter Nose End (B)	Diameter Drive End (C)	Opening Depth (D)
7624	3/4	2	1 1/2	1 1/2	15/32
7628	7/8	2	1 3/4	1 3/4	5/8
7630	15/16	2 1/8	1 7/8	1 3/4	5/8
7632	1	2 1/8	2	1 3/4	5/8
7636	1 1/8	2 1/8	2 1/8	2 1/8	3/4

3/4" Square Drive Universal Wrenches, SAE

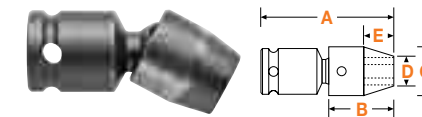

6 Point

Part Number 6 Point	Hex Opening In.	Overall Length (A) In.	Socket Length (B) In.	Socket Diameter (C) In.	Nose End Diameter (D) In.	Clearance Depth (E) In.
SA-535	15/16	3 25/32	1 3/4	1 1/2	1 3/8	29/32
SA-601	15/16	4 1/32	1 15/16	1 3/4	1 1/2	29/32
SA-537	1 1/16	3 29/32	1 7/8	1 5/8	1 5/8	1 1/32
SA-603	1 1/16	4 3/32	2	1 3/4	1 5/8	31/32
SA-538	1 1/8	3 29/32	1 7/8	1 5/8	1 5/8	1 1/32
SA-604	1 1/8	4 5/32	2 1/16	1 3/4	1 3/4	1 1/32
SA-606	1 1/4	4 7/32	2 1/8	1 7/8	1 7/8	1 3/32
SA-607	1 5/16	4 7/32	2 1/8	1 7/8	1 7/8	1 3/32
SA-609	1 7/16	4 11/32	2 1/4	2 1/8	2 1/8	1 5/32
SA-610	1 1/2	4 11/32	2 1/4	2 1/4	2 1/4	1 5/32
SA-712	1 5/8	4 11/32	2 3/8	2 3/8	2 3/8	1 3/16
SA-716	1 7/8	4 11/32	2 3/8	2 5/8	2 5/8	1 3/16

Universal wrenches must not be used with impact drivers.
Maximum operating angle is 30°.

3/4" Sq. Dr. Sockets, Metric

6 Point, Standard Length

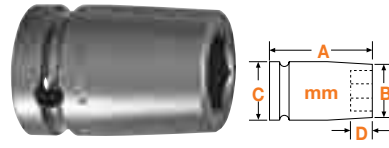

Part Number 6 Point	Hex Opening mm	Overall Length (A)	Diameter Nose End (B)	Diameter Drive End (C)	Opening Depth (D)
17mm17	17	51	31.8	38.1	11.2
18mm17	18	51	31.8	38.1	11.2
19mm17	19	51	31.8	38.1	11.9
20mm17	20	51	33.3	38.1	11.9
21mm17	21	51	34.9	38.1	13.5
22mm17	22	51	38.1	38.1	14.3
22mm47*	22	51	33.3	34.9	14.3
24mm17	24	51	38.1	38.1	15.9
24mm47*	24	51	34.9	34.9	15.9
26mm17	26	51	41.3	41.3	15.9
27mm17	27	51	44.4	44.4	17.5
27mm47*	27	51	38.1	38.1	17.5
29mm17	29	54	47.6	44.4	19.1
30mm17	30	54	47.6	44.4	19.1
30mm47*	30	54	41.3	41.3	19.1
32mm17	32	54	50.8	44.4	20.6
32mm47*	32	54	44.4	44.4	20.6
33mm17	33	54	50.8	44.4	20.6
36mm17	36	57	57.1	54.0	23.8
37mm17	37	57	57.1	54.0	23.8
41mm17	41	57	63.5	54.0	31.8
46mm17	46	57	69.9	54.0	31.8

*Thin Wall

6 Point, Extra Long Length



Part Number 6 Point	Hex Opening mm	Overall Length (A)	Diameter Nose End (B)	Diameter Drive End (C)	Opening Depth (D)
21mm37	21	102	34.9	38.1	13.5
21mm57*	21	102	34.9	34.9	13.5
22mm57*	22	102	34.9	34.9	14.3
24mm37	24	102	38.1	38.1	15.9
24mm57*	24	102	34.9	34.9	15.9
25mm37	25	102	38.1	38.1	15.9
27mm37	27	102	41.3	41.3	17.5
27mm57*	27	101.6	38.1	38.1	17.5
28mm37	28	101.6	44.4	44.4	19.1
29mm37	29	101.6	44.4	44.4	19.1
30mm37	30	101.6	44.4	44.4	19.1
30mm57*	30	101.6	42.9	42.9	19.1
32mm37	32	101.6	47.6	44.4	20.6
33mm37	33	101.6	50.8	44.4	20.6
34mm37	34	101.6	54.0	54.0	20.6
36mm37	36	101.6	54.0	54.0	23.8
41mm37	41	101.6	63.5	54.0	28.6

*Thin Wall

3/4" Sq. Dr. Extensions

2 1/4" to 15" (57mm to 381mm) Length



Part Number	Male Square In.	Type of Lock	Overall Length In.	Overall Length mm
EX-753	3/4	7/32 Drill Hole	2 1/4	57
EX-753-B	3/4	Ball	2 1/4	57
EX-755-4	3/4	7/32 Drill Hole	4	102
EX-755-B-4	3/4	Ball	4	102
EX-755-6	3/4	7/32 Drill Hole	6	152
EX-755-B-6	3/4	Ball	6	152
EX-755-8	3/4	7/32 Drill Hole	8	203
EX-755-B-8	3/4	Ball	8	203
EX-755-10	3/4	7/32 Drill Hole	10	254
EX-755-12	3/4	7/32 Drill Hole	12	305
EX-755-B-12	3/4	Ball	12	305
EX-755-15	3/4	7/32 Drill Hole	15	381
EX-755-B-15	3/4	Ball	15	381

3/4" Sq. Dr. Adapters

1/2" to 1" Male Square



Part Number	Male Square In.	Female Square In.	Type of Lock	Overall Length In.	Overall Length mm
EX-506	1/2	3/4	Pin	2	51
EX-506-B	1/2	3/4	Ball	2	51
EX-510-3	1/2	3/4	Pin	3	76
EX-510-B-3	1/2	3/4	Ball	3	76
EX-510-4	1/2	3/4	Pin	4	102
EX-510-B-4	1/2	3/4	Ball	4	102
EX-510-B-5	1/2	3/4	Ball	5	127
EX-510-6	1/2	3/4	Pin	6	152
EX-510-B-6	1/2	3/4	Ball	6	152
EX-510-8	1/2	3/4	Pin	8	203
EX-510-B-8	1/2	3/4	Ball	8	203
EX-625	5/8	3/4	Pin	2	51
EX-625-B	5/8	3/4	Ball	2	51
EX-628-3	5/8	3/4	Pin	3	76
EX-1000	1	3/4	9/32 Drill Hole	2 9/16	65
EX-1000-B	1	3/4	Ball	2 9/16	65

3/4" Sq. Dr. Universal Adapters

3/4" Male Square



Part Number	Male Sq. In.	Female Sq. In.	Type of Lock	Overall Length In.	Overall Length mm	Largest Diameter In.	Largest Diameter mm
MF-75	3/4	3/4	7/32 Drill Hole	4	102	1 1/2	38
MF-75B	3/4	3/4	Ball	4	102	1 1/2	38
MF-76	3/4	3/4	7/32 Drill Hole	4 3/8	111	1 3/4	45
MF-76B	3/4	3/4	Ball	4 3/8	111	1 3/4	45

Universal wrenches must not be used with impact drivers. Maximum operating angle is 30°.-

1" Square Drive Sockets, SAE

6 Point & Double Hex, Standard Length



Part Number 6 Point	Part Number Double Hex	Hex Opening In.	Overall Length (A)	Diameter Nose End (B)	Diameter Drive End (C)	Opening Depth (D)
-	8124-D	3/4	2 1/8	1 5/16	2	13/16
8126	-	13/16	2 1/8	1 3/8	2	13/16
-	8128-D	7/8	2 1/8	1 1/2	2	13/16
-	8130-D	15/16	2 1/8	1 1/2	2	13/16
-	8132-D	1	2 1/8	1 5/8	2	13/16
-	8134-D	1 1/16	2 1/8	1 11/16	2	13/16
-	8136-D	1 1/8	2 1/8	1 3/4	2	13/16
8138	8138-D	1 3/16	2 1/8	2 1/8	2	13/16
-	8140-D	1 1/4	2 1/8	2 1/8	2 1/8	13/16
8142	8142-D	1 5/16	2 1/8	2 1/8	2 1/8	13/16
-	8144-D	1 3/8	2 1/8	2 1/8	2 1/8	13/16
-	8146-D	1 7/16	2 1/4	2 1/4	2 1/8	15/16
8148	8148-D	1 1/2	2 1/4	2 1/4	2 1/8	15/16
-	8150-D	1 9/16	2 1/4	2 3/8	2 1/8	15/16
8152	-	1 5/8	2 3/8	2 1/2	2 1/8	15/16
8160	-	1 7/8	2 1/2	2 3/4	2 5/8	1 1/16
8162	8162-D	1 15/16	2 1/2	2 7/8	2 5/8	1 1/16
8170	-	2 3/16	2 3/4	3 1/4	3 1/4	1 5/16
8172	-	2 1/4	2 3/4	3 1/4	3 1/4	1 5/16
8174	-	2 5/16	2 3/4	3 3/8	3 1/4	1 3/8
8176	-	2 3/8	2 7/8	3 1/2	3 1/4	1 3/8
8180	-	2 1/2	2 7/8	3 3/4	3 1/4	1 3/8
8186	-	2 11/16	3	4	3 1/4	1 1/2
8188	-	2 3/4	3 1/8	4	3 1/4	1 5/8
8190	-	2 13/16	3 1/8	4	3 1/4	1 5/8

6 Point & Double Hex, Thin Wall Standard Length

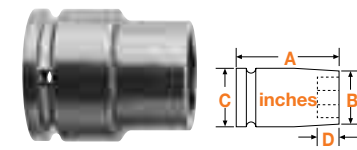

Part Number 6 Point	Part Number Double Hex	Hex Opening In.	Overall Length (A)	Diameter Nose End (B)	Diameter Drive End (C)	Opening Depth (D)
-	8430-D	15/16	2 1/8	1 7/16	1 7/8	13/16
8432	8432-D	1	2 1/8	1 1/2	1 7/8	13/16
8434	-	1 1/16	2 1/8	1 9/16	1 7/8	13/16
8436	-	1 1/8	2 1/8	1 5/8	1 7/8	13/16
8440	8440-D	1 1/4	2 1/8	1 13/16	2	13/16
8442	8442-D	1 5/16	2 1/8	1 7/8	2	13/16
-	8444-D	1 3/8	2 1/8	1 15/16	2	13/16
8448	8448-D	1 1/2	2 1/4	2 1/8	2 1/8	15/16
8454	-	1 11/16	2 3/8	2 3/8	2 1/8	15/16
8456	-	1 3/4	2 3/8	2 7/16	2 1/8	1 1/16
8458	-	1 13/16	2 1/2	2 9/16	2 1/8	1 1/16
8460	-	1 7/8	2 1/2	2 5/8	2 5/8	1 1/16
8464	-	2	2 5/8	2 3/4	2 5/8	1 3/16
-	-	2 1/8	2 5/8	2 15/16	2 5/8	1 3/16
8472	-	2 1/4	2 3/4	3 1/8	2 5/8	1 5/16
8480	-	2 1/2	2 7/8	3 3/8	3 1/4	1 7/16

6 Point, Long Length



Part Number 6 Point	Hex Opening In.	Overall Length (A)	Diameter Nose End (B)	Diameter Drive End (C)	Opening Depth (D)
8228	7/8	3	1 7/16	2 1/8	9/16
8236	1 1/8	3	1 3/4	2 1/8	3/4
8240	1 1/4	3	2 1/8	2 1/8	13/16

6 Point, Extra Long Length



Part Number 6 Point	Hex Opening In.	Overall Length (A)	Diameter Nose End (B)	Diameter Drive End (C)	Opening Depth (D)
8324	3/4	4 1/4	1 1/4	2 1/8	15/32
8326	13/16	4 1/4	1 3/8	2 1/8	17/32
8332	1	4 1/4	1 9/16	2 1/8	5/8
8336	1 1/8	4 1/4	1 3/4	2 1/8	3/4
8338	1 3/16	4 1/4	1 7/8	2 1/8	3/4
8340	1 1/4	4 1/4	2 1/8	2 1/8	13/16
8342	1 5/16	4 1/4	2 1/8	2 1/8	13/16
8346	1 7/16	4 1/4	2 1/4	2 1/8	15/16
8356	1 3/4	4 1/4	2 5/8	2 5/8	1 1/8
8360	1 7/8	4 1/4	2 3/4	2 5/8	1 1/4
8364	2	4 3/8	2 7/8	2 5/8	1 3/8
8370	2 3/16	4 1/2	3 1/8	2 5/8	1 1/2
8378	2 7/16	4 1/2	3 1/2	3 1/4	1 5/8
8380	2 1/2	4 1/2	3 1/2	3 1/4	1 5/8
8382	2 9/16	4 1/2	3 3/4	3 1/4	1 3/4
8384	2 5/8	4 1/2	3 3/4	3 1/4	1 3/4

6 Point, Thin Wall, Extra Long Length

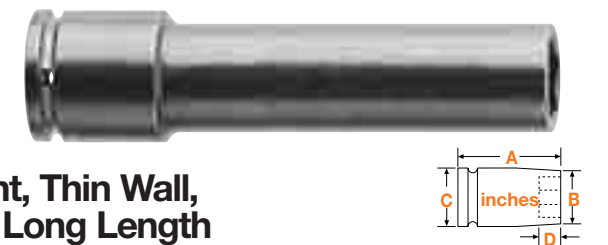

Part Number 6 Point	Hex Opening In.	Overall Length (A)	Diameter Nose End (B)	Diameter Drive End (C)	Opening Depth (D)
8530	15/16	4 1/4	1 1/2	2 1/8	5/8
8536	1 1/8	4 1/4	1 5/8	2 1/8	3/4
8540	1 1/4	4 1/4	1 13/16	2 1/8	13/16
8542	1 5/16	4 1/4	1 7/8	2 1/8	13/16

1" Sq. Dr. Sockets, SAE

Single Square & Double Square, Standard Length

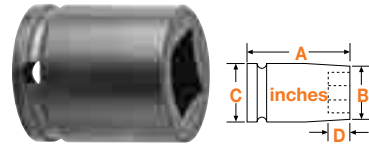

Part No. Single Square	Part No. Double Square	Square Opening In.	Overall Length (A)	Diameter Nose End (B)	Diameter Drive End (C)	Opening Depth (D)
8624	-	3/4	2 1/8	1 5/8	2	13/16
8632	-	1	2 1/8	2 1/8	2 1/8	13/16
8634	-	1 1/16	2 1/8	2 1/8	2 1/8	13/16
8636	-	1 1/8	2 1/4	2 1/4	2 1/8	15/16
8638	8638-D	1 3/16	2 1/4	2 1/4	2 1/8	15/16
8640	8640-D	1 1/4	2 1/4	2 3/8	2 1/8	15/16
8644	-	1 3/8	2 5/16	2 5/8	2 5/8	1
-	8646-D	1 7/16	2 3/8	2 5/8	2 5/8	1
8648	-	1 1/2	2 3/8	2 3/4	2 5/8	1 1/16
-	8652-D	1 5/8	2 1/2	2 7/8	2 5/8	1 1/16

Budd Wheel Sockets

13/16" Square & Combo
13/16" Square 1 1/2" Hex



Part Number	Drive	Overall Length In.	mm
BW-8626	1" Square	2 1/8	54
BW-848	1" Square	3 3/4	95
BW-848-F	1" Square	3 3/4	95

13/16" Square
Combo. 13/16 Square—1 1/2" Hex for mag. wheels

1" Sq. Dr. Sockets, Metric

6 Point, Standard Length



Part Number 6 Point	Hex Opening mm	Overall Length (A)	Diameter Nose End (B)	Diameter Drive End (C)	Opening Depth (D)
21mm18	21	54	34.9	50.8	13.5
24mm18	24	54	38.1	50.8	20.6
27mm18	27	54	42.9	50.8	20.6
29mm18	29	54	47.6	50.8	20.6
30mm18	30	54	50.8	50.8	20.6
30mm48*	30	54	44.4	54.0	20.6
32mm18	32	54	54.0	54.0	20.6
34mm18	34	54	54.0	54.0	20.6
36mm18	36	57	57.1	54.0	23.9
41mm18	41	60	63.5	54.0	23.9
42mm18	42	60	63.5	54.0	23.9
46mm18	46	64	69.8	66.7	26.9
50mm18	50	66	76.2	66.7	30.2

*Thin Wall

6 Point, Long Length



Part Number 6 Point	Hex Opening mm	Overall Length (A)	Diameter Nose End (B)	Diameter Drive End (C)	Opening Depth (D)
24mm38	24	108	38.1	54.0	15.9
27mm38	27	108	41.3	54.0	17.5
28mm38	28	108	44.4	54.0	19.1
33mm38	33	108	54.0	54.0	20.6
36mm38	36	108	54.0	54.0	23.8
37mm38	37	108	57.1	54.0	23.8
46mm38	46	108	69.8	66.7	31.8
50mm38	50	111	73.0	66.7	34.9

1" Sq. Dr. Extensions

2 13/16" to 15" (71mm to 381mm) Length



Part Number	Male Square In.	Type of Lock	Overall Length In.	mm
EX-1001	1	9/32 Drill Hole	2 13/16	71
EX-1001-B	1	Ball	2 13/16	71
EX-1003-4	1	9/32 Drill Hole	4	102
EX-1003-B-4	1	Ball	4	102
EX-1003-6	1	9/32 Drill Hole	6	152
EX-1003-B-6	1	Ball	6	152
EX-1003-8	1	9/32 Drill Hole	8	203
EX-1003-B-8	1	Ball	8	203
EX-1003-10	1	9/32 Drill Hole	10	254
EX-1003-B-10	1	Ball	10	254
EX-1003-12	1	9/32 Drill Hole	12	305
EX-1003-B-12	1	Ball	12	305
EX-1003-15	1	9/32 Drill Hole	15	381
EX-1003-B-15	1	Ball	15	381

1" Sq. Dr. Adapters

3/4" to 1 1/2" Male Square



Part Number	Male Square In.	Female Square In.	Type of Lock	Overall Length In.	mm
EX-754	3/4	1	7/32 Drill Hole	2 13/16	71
EX-754-B	3/4	1	Ball	2 13/16	71
EX-756-4	3/4	1	7/32 Drill Hole	4	102
EX-756-6	3/4	1	7/32 Drill Hole	6	152
EX-756-8	3/4	1	7/32 Drill Hole	8	203
EX-1101	1 1/2	1	3/8 Drill Hole	3 9/16	91

1" Sq. Dr. Universal Adapters

3/4" to 1" Male Square



Part Number	Male Sq. In.	Female Sq. In.	Type of Lock	Overall Length In.	mm	Largest Diameter In.	mm
MF-77B	3/4	1	Ball	4 3/4	121	2	51
MF-82	1	1	9/32 Drill Hole	5	127	2	51
MF-82B	1	1	Ball	5	127	2	51

Universal wrenches must not be used with impact drivers. Maximum operating angle is 30°.-

1 1/2" Sq. Dr. Sockets, SAE

6 Point, Standard Length

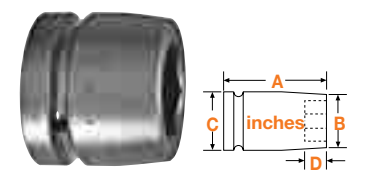

Part Number 6 Point	Hex Opening In.	Overall Length (A)	Diameter Nose End (B)	Diameter Drive End (C)	Opening Depth (D)
9172	2 1/4	3 1/4	3 3/8	3 1/4	1 1/2

Additional sizes available upon request.

1 1/2" Sq. Dr. Adapters

1" Male Square



Part Number	Male Square In.	Female Square In.	Type of Lock	Overall Length In.	mm
EX-1005	1	1 1/2	9/32 Drill Hole	3 15/16	100
EX-1005-B	1	1 1/2	Ball	3 15/16	100

2 1/2" Sq. Dr. Sockets, SAE

6 Point, Standard Length

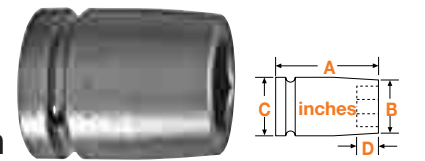

Part Number 6 Point	Hex Opening In.	Overall Length (A)	Diameter Nose End (B)	Diameter Drive End (C)	Opening Depth (D)
01112	3 1/2	4 3/4	5 1/2	5 1/2	2 1/2

Additional sizes available upon request.

If the tool you need does not appear in this catalog, give us a call. The odds are, we may have what you need as a non-catalog item. If not, our experienced staff of tooling experts can design and manufacture "specials" to meet the needs of your specific application. Give us a call at 1-800-845-5629 or visit our website www.apex-tools.com.

APEX μ -Guard™

Quality Anti-Mar Fastener Tools Begin With Quality Fastener Tools.

Apex μ -Guard provides a protective barrier between genuine Apex fastener tools and your finely finished workpiece. The free-spinning patent-pending design provides maximum protection for polished and highly sensitive surfaces.

Apex μ -Guard covering is made of a thermo plastic urethane (TPU elastomer) which cushions against costly incidental side impacts. It offers the lowest sustained coefficient of friction for maximum tool efficiency. It is also non-removable for tamper resistance.

With Apex μ -Guard you get the proven Apex fastener tool fit and performance plus the best protection available against marring and in-system damage. μ -Guard is your guard against the potential hazards caused by rotational friction.



If it doesn't say Apex on the outside, how can you be sure of what's on the inside?

"Cushioning" Effect Minimizes Side Impact Damage



Free-Spinning Design



Virtually Damage Free



Why Apex μ -Guard Anti-Mar Fastener Tools Are The Best Choice

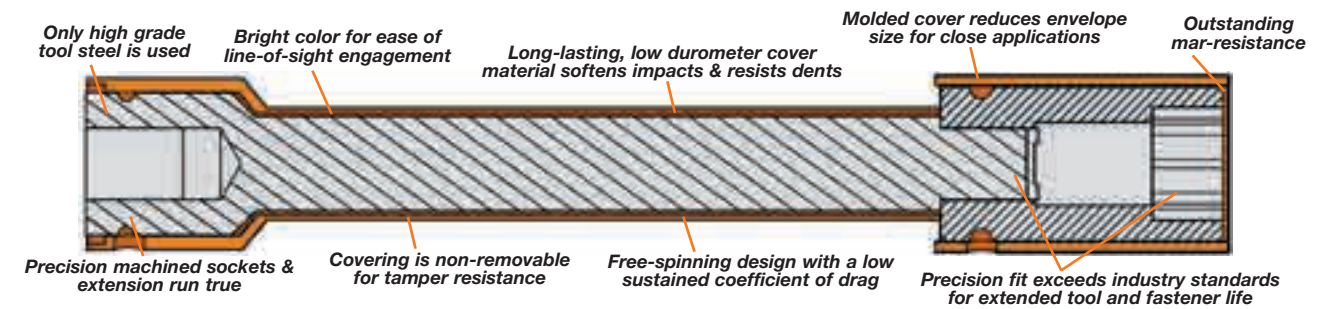

Quality Apex Tools Under The Cover

- Apex fastener tools are made from only tool grade steel then heat treated using our proprietary process for the proper hardness based on the application. Not too brittle to break nor too soft to wear out after one shift.
- Each core tool is then machined for a precision fit that exceeds industry standards. Improper fit can lead to premature fastener and fastener tool failure.
- Apex fastener tools run true with minimal wobble for more efficient fastening cycles.

The Cover Story

- A low durometer cover material that resists dents during incidental side impacts. Only Apex μ -Guard absorbs side impacts and does not produce raised burrs when impacted.
- Cover is molded to the tool for reduced envelope dimensions yet still is able to exhibit "free-spinning" capability for improved ergonomics and safety. No other competitor has this capability. Some competitors even require their core tool be modified in order to assemble the cover resulting in weaker integrity and premature failure.
- Covering is non-removable to prevent unwanted tampering on the line.
- Low sustained coefficient of friction between the cover and the tool yields minimal loss of tool efficiency.
- Bright color of covering makes fastener contact visually easier shift after shift and station monitoring quick and easy.
- Part numbers are clearly marked for ease of identification.
- Only Apex has the manufacturing capability, inventory and global supply network to supply the global requirements of today's marketplace.

μ-Guard Sockets

(Includes socket and cover)



Part Number	Socket	Drive End			Socket Length	Fastener End			Assembly Features*
		Size	Type	Sex		Size	Type	Sex	
UG-10MM21	10MM21	1/4	Square	F	standard	10 mm	Hex	F	FS
UG-M-10MM21	M-10MM21	1/4	Square	F	standard	10 mm	Hex	F	FS, M
UG-MB-10MM21	MB-10MM21	1/4	Square	F	standard	10 mm	Hex	F	FS, M, B
UG-10MM13	10MM13	3/8	Square	F	standard	10 mm	Hex	F	FS
UG-M-10MM13	M-10MM13	3/8	Square	F	standard	10 mm	Hex	F	FS, M
UG-10MM23	10MM23	3/8	Square	F	long	10 mm	Hex	F	FS
UG-M-10MM23	M-10MM23	3/8	Square	F	long	10 mm	Hex	F	FS, M
UG-MB-10MM23	MB-10MM23	3/8	Square	F	long	10 mm	Hex	F	FS, M, B
UG-13MM23	13MM23	3/8	Square	F	long	13 mm	Hex	F	FS
UG-M-13MM23	M-13MM23	3/8	Square	F	long	13 mm	Hex	F	FS, M
UG-MB-13MM23	MB-13MM23	3/8	Square	F	long	13 mm	Hex	F	FS, M, B
UG-13MM25	13MM25	1/2	Square	F	long	13 mm	Hex	F	FS
UG-SF-13MM25	SF-13MM25	1/2	Square	F	long	13 mm	Hex	F	FS, SF
UG-15MM25	15MM25	1/2	Square	F	long	15 mm	Hex	F	FS
UG-SF-15MM25	SF-15MM25	1/2	Square	F	long	15 mm	Hex	F	FS, SF
UG-18MM25	18MM25	1/2	Square	F	long	18 mm	Hex	F	FS
UG-SF-18MM25	SF-18MM25	1/2	Square	F	long	18 mm	Hex	F	FS, SF

If your tool is not shown in the table of representative products above, please contact your Apex representative.

μ-Guard Extensions

(Includes extension and cover)



Part Number	Extension	Drive End			Extension Length	Socket End			Assembly Features*
		Size	Type	Sex		Size	Type	Sex	
UG-EX-250-4	EX-250-4	1/4	Hex	M	4	1/4	Square	M	FS
UG-EX-250-6	EX-250-6	1/4	Hex	M	6	1/4	Square	M	FS
UG-EX-370-2	EX-370-2	1/4	Hex	M	2	3/8	Square	M	FS
UG-EX-370-4	EX-370-4	1/4	Hex	M	4	3/8	Square	M	FS
UG-EX-370-6	EX-370-6	1/4	Hex	M	6	3/8	Square	M	FS
UG-EX-376-3	EX-376-3	3/8	Square	F	3	3/8	Square	M	FS
UG-EX-376-6	EX-376-6	3/8	Square	F	6	3/8	Square	M	FS
UG-EX-376-12	EX-376-12	3/8	Square	F	12	3/8	Square	M	FS
UG-EX-508-4	EX-508-4	1/2	Square	F	4	1/2	Square	M	FS
UG-EX-508-8	EX-508-8	1/2	Square	F	8	1/2	Square	M	FS
UG-EX-508-12	EX-508-12	1/2	Square	F	12	1/2	Square	M	FS

If your tool is not shown in the table of representative products above, please contact your Apex representative.

μ-Guard Bit Holders

(Includes bit holder and cover)



Part Number	Bit Holder	Drive End			Holder Length	Fastener End			Assembly Features*
		Size	Type	Sex		Size	Type	Sex	
UG-M-490	M-490	1/4	Hex	M	2 31/32	1/4	Hex	F	FS, M, ET
UG-M-490-4	M-490-4	1/4	Hex	M	4	1/4	Hex	F	FS, M, ET
UG-M-490-6	M-490-6	1/4	Hex	M	6	1/4	Hex	F	FS, M, ET
UG-825	825	1/4	Square	F	1	1/4	Hex	F	FS, ET
UG-M-825	M-825	1/4	Square	F	2 9/32	1/4	Hex	F	FS, M, ET
UG-838	838	3/8	Square	F	1 1/2	1/4	Hex	F	FS, ET
UG-M-838	M-838	3/8	Square	F	2 5/8	1/4	Hex	F	FS, M, ET
UG-835	835	3/8	Square	F	1 1/2	5/16	Hex	F	FS, ET
UG-M-835	M-835	3/8	Square	F	2 3/4	5/16	Hex	F	FS, M, ET
UG-855	855	1/2	Square	F	1 1/2	5/16	Hex	F	FS, ET
UG-M-855	M-855	1/2	Square	F	2 3/4	5/16	Hex	F	FS, M, ET
UG-M-858	M-858	1/2	Square	F	2 3/4	1/4	Hex	F	FS, M, ET

If your tool is not shown in the table of representative products above, please contact your Apex representative.

***Features Abbreviations**
FS Free Spinning Tool is able to rotate independently of Cover
M Magnetic Tool includes magnet to hold the position of the fastener during fastening operation
ET Extended Tip Cover extends beyond end of Bit Holder to shield the majority of a standard Insert Bit.*

*Bit holder covers can be used with 1" or 1 1/4" long insert bits. Tip of cover can be modified by end user to suit application requirements or preference. Suggested methods of modifying covers include cutting to preferred length or heating up cover material and conforming to fastener head configuration.

Notes: Reported lengths are based on uncovered tool length only for reference. Cover may extend beyond end of tool by 2 mm unless otherwise noted.

Don't see what you need?

This catalog contains 3,000+ of the most frequently requested bits, sockets and fastening accessories. Our entire active offering approaches 10,000 sellable part numbers. If the tool you need does not appear in this catalog, give us a call. The odds are, we may have what you need as a non-catalog item. If not, our experienced staff of tooling experts can design and manufacture "specials" to meet the needs of your specific applications.

This flexibility has helped make Apex the only manufacturer which is a market and technology leader in all of the following industrial product categories: Bits & Bit Holders, Impact Sockets, Extensions and Universal Wrenches.

Get a quote on-line fast!

You can even specify custom tooling on-line fast! Specification sheets for bits, sockets, extensions and



universal joints are available on-line. Just complete the appropriate easy to use form and submit your request. You'll receive a rapid response from one of our experienced staff of tooling experts.



Easy to complete forms are available on-line at our website www.apex-tools.com.

If the tool you need does not appear in this catalog, give us a call. The odds are, we may have what you need as a non-catalog item. If not, our experienced staff of tooling experts can design and manufacture "specials" to meet the needs of your specific applications.



Apex® Has A Wide Selection Of Custom Designed Anti-Mar Covers.



Over Half A Century Of Quality In Every Design

For many years Apex has been producing protective covers for our quality products. Each was custom designed by our staff of engineers to work in a specific application. Over time we have developed a vast library of designs that work not only for their original applications but may also be a solution for one of your applications.



Our covered product designs include sockets, sockets and extensions, bits and bit holders, nutsetters and many more.

Each design was developed with one or more of the following unique features and capabilities:

- Free-spinning covers which allow the tool to rotate independently of the cover for improved protection of sensitive surfaces.
- Spring-loaded covers which retract when engaging the fastener.
- Embedded magnets in covers increase holding force on fastener.
- Single-piece construction to reduce material interfaces.
- Press fit/non-free-spinning for reduced envelope size in tight clearance applications.

Apex recognizes the need in assembly operations for the protection of painted or finished surfaces. We can coat just about any Apex bit or socket with a protective nylon sleeve. Shown above are some recently manufactured solutions with a brief description of the application.

- 1. Pick-up Truck Tailgate to Bed**
Torx® T-50 Bit with magnets within the sleeve to secure fastener. **WJ-1506-T50**
- 2. Sun Visor Installation**
Phillips bit used with magnetic bit holder. Nylon sleeve reduces headliner and visor damage. **SD-5241-A**
- 3. Lug Nut Assembly**
Magnetic 19MM socket has nylon coating to protect chrome plated and polished aluminum wheels. **HGSFNC-3028**
- 4. Antenna Driver**
Four-prong antenna bezel nutdriver with nylon sleeve to reduce damage to painted surface. **BZCNC-30, -31**
- 5. Spare Tire Wing Nut Assembly**
All nylon socket to install low torque wing nut. **WJ-1405**
- 6. Painted Door Assembly**
Only the nutsetter spins within the nylon sleeve, eliminating any mark on surface around the fastener. Nylon sleeve also protects adjacent painted door surface. **MNC6N-08-10M-4**

APEX® Solutions

Does Apex offer sockets for the installation of grease fittings?

Specially designed Apex sockets are the easy way to install or remove grease fittings.

(See page 75)



What's the real advantage of using socket adapters?

Socket adapters are an easy and economical solution for applications that require several different nut sizes.

(See page 77)



Does Apex offer tap holding sockets?

Apex offers a wide variety of tap holding adapters. These adapters allow you to easily convert your power tool into a tap drill.

(See page 74)

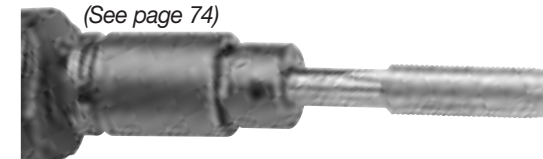

What's the advantage of a male hex drive socket?

A male hex drive socket lets you quickly accommodate a different nut size without pulling the primary socket off the power tool.

(See page 77)



Reversible Sockets for SAE Hex Head Sheet Metal Screws



Standard

Part Number	Hex Size	Overall Length	Outside Diameter	Roll Pin Part Number
SW-350	1/4	9/16	3/8	21-S-078-0375
SH-402	13/16	3/4	13/16	21-S-078-0750

Magnetic

Part Number	Hex Size	Overall Length	Outside Diameter	Spring Pin Part Number
MSW-350	1/4	31/32	3/8	21-S-078-0375
MSW-90	1/4	31/32	7/16	21-S-078-0437
MSW-90-B*	1/4	31/32	7/16	21-S-078-0437
MSW-984	5/16	31/32	9/16	21-S-078-0562
MSW-984-B*	5/16	31/32	9/16	21-S-078-0562
MSH-400	3/8	1 1/8	11/16	21-S-078-0687

*Tapered Ends

Shanks for Reversible Sockets



Part Number	Male Hex Power Drive	Male Hex Size	Overall Length	
SH-629	1/4	1/4	2	
SH-629-P	1/4	1/4	2	Pin Lock
SH-629-5	1/4	1/4	5	
SH-629-6	1/4	1/4	6	
SH-57	1/4	1/4	2	Full Length Hex
SH-57-3	1/4	1/4	3	Full Length Hex
SH-57-4	1/4	1/4	4	Full Length Hex
SH-57-6	1/4	1/4	6	Full Length Hex
SH-57-8	1/4	1/4	8	Full Length Hex
SH-59	1/4	5/16	2	
SH-59-3	1/4	5/16	3	
SH-59-4	1/4	5/16	4	
SH-59-6	1/4	5/16	6	
SH-412	1/4	3/8	2	
SH-414	1/4	1/2	2	
SH-404	7/16	3/8	2	

Valve Stem Drivers

1/4" Male Hex Drive

Part Number	Slot Size	Overall Length In.	Overall Length mm	Body Diameter In.	Body Diameter mm
SD-5197	0.09"	1.68	42.67	0.181	4.6
SD-5187	0.109"	2.5	63.50	0.176	4.5

Tap Holding Sockets

Male Hex Drive, SAE



(Tap not included)

Part Number	Tap Size	Male Hex	Socket Length In.	Socket Length mm	Socket Diameter In.	Socket Diameter mm
SJ-935-1/4	1/4	7/16	15/16	24	5/8	16
SJ-935-5/16	5/16	1/2	15/16	24	5/8	16
SJ-935-3/8 FS	3/8	9/16	1	25	21/32	17
SJ-935-7/16	7/16	5/8	1	25	3/4	19
SJ-935-1/2	1/2	3/4	1 1/4	32	7/8	22

Male Hex Drive, Metric



(Tap not included)

Part Number	Tap Size	Male Hex	Socket Length In.	Socket Length mm	Socket Diameter In.	Socket Diameter mm
SJ-935-10MMX6	M6	10	15/16	24	5/8	16
SJ-935-12MMX8	M8	12	15/16	24	5/8	16
SJ-935-14MMX10	M10	14	1	25	21/32	17
SJ-935-17MMX8	M8	17	1	25	13/16	21
SJ-935-17MMX12	M12	17	1	25	13/16	21

Female Sq. Dr., SAE



Part Number	Tap Size	Female Square	Socket Length In.	Socket Length mm	Socket Diameter In.	Socket Diameter mm
HC-100-10	#10	3/8	1 1/2	38	3/4	19
HC-100-1/4	1/4	3/8	1 1/2	38	3/4	19
HC-100-5/16	5/16	3/8	1 1/2	38	3/4	19
HC-100-3/8 FS	3/8	3/8	1 1/2	38	3/4	19
HC-100-7/16	7/16	3/8	1 1/2	38	3/4	19
HC-100-1/2	1/2	3/8	1 1/2	38	3/4	19
HC-100-5/8	5/8	3/8	1 3/4	46	1	25
HC-100-3/4	3/4	3/8	2	51	1	25
HE-100-1/4	1/4	1/2	1 1/2	38	7/8	22
HE-100-5/16	5/16	1/2	1 1/2	38	7/8	22
HE-100-3/8 FS	3/8	1/2	1 1/2	38	7/8	22
HE-100-7/16	7/16	1/2	1 1/2	38	7/8	22
HE-100-1/2	1/2	1/2	1 5/8	41	7/8	22
HE-100-5/8	5/8	1/2	1 3/4	46	1	25
HE-100-3/4	3/4	1/2	2	51	1	25

Ferry Cap® Sockets

3/8" Square Drive

Part Number	Head Size	Overall Length In.	Overall Length mm	Nose Diameter In.	Nose Diameter mm	Drive Diameter In.	Drive Diameter mm
FC-310	5/16"	1 1/4	31.75	15/32	11.9	5/8	15.9
FC-312	3/8"	1 1/4	31.75	9/16	4.3	3/4	19.0

Grease Fitting Sockets

For Angled Grease Fittings, Deep and Shallow Broach Depth



Part Number	Hex Size	Square Drive	Overall Length In.	Overall Length mm	Broach Depth In.	Broach Depth mm	Magnet Depth In.	Magnet Depth mm
ZN-112	-	3/8	1/4	1 1/4	32	9/16	14	-
ZN-312	MZN-312	3/8	3/8	1 1/2	38	9/16	14	7/32
ZN-512	-	3/8	1/2	1 1/2	32	9/16	14	-
ZN-114	-	7/16	1/4	1 1/4	32	7/16	11	-
ZN-314	MZN-314	7/16	3/8	1 1/2	38	7/16	11	7/16
ZN-514	MZN-514	7/16	1/2	1 1/2	38	7/16	11	7/16
ZE-112	-	3/8	1/4	1 1/4	32	1/8	3	-
ZE-314	-	7/16	3/8	1 1/2	38	3/16	5	-
ZE-514	-	7/16	1/2	1 1/2	38	3/16	5	-

For Straight Grease Fittings



Part Number	Hex Size	Square Drive	Overall Length In.	Overall Length mm	Broach Depth In.	Broach Depth mm	Magnet Depth In.	Magnet Depth mm
ZA-110	MZA-110	5/16	1/4	1	25	1/8	3	21/64
ZA-310	MZA-310	5/16	3/8	1 1/4	32	1/8	3	21/64
ZA-510	MZA-510	5/16	1/2	1 1/2	38	1/8	3	19/64
ZA-512	-	3/8	1/2	1 1/2	38	1/8	3	-
ZA-314	MZA-314	7/16	3/8	1 1/4	32	3/16	5	23/64
ZA-514	MZA-514	7/16	1/2	1 1/2	38	3/16	5	3/8

Drill Holders

1/4" Male Hex Drive



Part Number	Drill Size	Overall Length In.	Overall Length mm	Body Diameter In.	Body Diameter mm
WJ-284-7/64	7/64	2 5/8	67	1/2	13
WJ-284-1/8	1/8	2 5/8	67	5/8	16
WJ-284-9/64	9/64	2 5/8	67	5/8	16
WJ-284-5/32	5/32	2 5/8	67	3/4	19
WJ-284-3/16	3/16	2 5/8	67	3/4	19
WJ-284-1/4	1/4	2 5/8	67	3/4	19
WJ-284-5/16	5/16	2 5/8	67	3/4	19
WJ-284-3/8	3/8	2 5/8	67	1	25

7/16" Male Hex Drive



Part Number	Drill Size	Overall Length In.	Overall Length mm	Body Diameter In.	Body Diameter mm
WJ-265-13/64	13/64	2 3/8	60	3/4	19
WJ-265-3/16	3/16	2 3/8	60	3/4	19
WJ-265-1/4	1/4	2 3/8	60	3/4	19
WJ-265-7/16	7/16	2 3/8	60	1	25
WJ-265-3/8	3/8	2 3/8	60	1	25
WJ-265-17/32	17/32	2 3/8	60	1 1/8	29
WJ-265-1/2	1/2	2 3/8	60	1 1/8	29

#5 (1 5/8") Spline Drive



Extensions

Part Number	Overall Length In.	Overall Length mm	Description
EXL-15	15	381	Female spline to male spline

Adapters

Part Number	Description
EXL-1000	Female spline to 1" male square
EXL-1100	Female spline to 1 1/2" male square

Universal Wrenches

Part Number	Description
MFL-250	Female spline to male spline (heavy duty)
MFL-1000	Female spline to 1" male square

Universal wrenches must not be used with impact drivers. Maximum operating angle is 30°.

#5 (1 5/8") Spline Drive Budd Wheel Sockets



Combo. 13/16" Square 1 1/2" Hex

Part Number	Drive	Overall Length In.	Overall Length mm
HT-848	#5 Spline	4 1/4	108

Socket Retaining Rings

Plastic Ring With Steel Insert



Part Number	Drive	Inside Diameter In.	mm
10005S	3/4" Square	1 1/4	31.8
10032S	3/4" Square	1 7/16	36.5
10034S	3/4" Square	1 5/8	41.3
10008S	1" Square	1 3/4	44.5
10010S	1" Square	2	50.8
10015S	1" Square	2 1/8	54.0
10016S	1" Square	2 1/4	57.2
10017S	1" Square	2 1/2	63.5
10019S	1" Square	2 5/8	66.7
10020S	1 1/2" Square	2 7/8	73.0
10025S	1 1/2" Square	3 3/8	85.7

Metal Ring



Part Number	Drive	Inside Diameter In.	mm
MET-1301C	3/8" Square	.677	17.2
MET-1302C	3/8" Square	.771	19.6
MET-1401C	1/2" Square	.885	22.5
MET-1402C	1/2" Square	1.086	27.6
MET-1600C	3/4" Square	1.594	40.5
MET-1800C	1" Square	1.948	49.5

Adapters

#130-A Yankee Drive for Spiral Type Driver



Part Number	Male Square In.	Overall Length In.	mm	Shank Diameter In.	mm
YK-250	1/4	1 15/16	49	.277	7.0
YK-370	3/8	2 3/16	56	.277	7.0
YK-500	1/2	2 5/16	59	.277	7.0

#131-A Yankee Drive for Spiral Type Driver



Part Number	Male Square In.	Overall Length In.	mm	Shank Diameter In.	mm
YK-501	1/2	2 5/16	59	.310	8.0

#135-A Yankee Drive for Spiral Type Driver



Part Number	Male Square In.	Overall Length In.	mm	Shank Diameter In.	mm
YK-252	1/4	1 15/16	49	.215	5.5
YK-372	3/8	2 3/16	56	.215	5.5
YK-502	1/2	2 5/16	59	.215	5.5

Female Threaded Adapters



Part Number	Female Thread	Male Square In.	Type of Lock
TH-257	3/8"-24	1/4	Pin
TH-377	3/8"-24	3/8	Pin
TH-501	3/8"-24	1/2	Pin
TH-378	1/2"-20	3/8	Pin
TH-502	1/2"-20	1/2	Pin

Male Threaded Adapters



Part Number	Male Thread	Hex Drive
TM-24	3/8"-24	1/4
TN-24	3/8"-24	7/16
TM-20	1/2"-20	1/4
TN-20	1/2"-20	7/16

Adapters

Socket & Ratchet Wrench Adapters, SAE



Part Number	Male Square In.	Male Hex In.	Overall Length In.
A-108	1/4	1/4	25/32
A-110	1/4	5/16	25/32
A-112	1/4	3/8	25/32
A-114	1/4	7/16	25/32
A-116	1/4	1/2	25/32
A-118	1/4	9/16	25/32
A-120	1/4	5/8	25/32
A-312	3/8	3/8	1 1/64
A-314	3/8	7/16	1 1/64
A-316	3/8	1/2	1 5/64
A-318	3/8	9/16	1 5/64
A-320	3/8	5/8	1 5/64
A-322	3/8	11/16	1 5/64
A-324	3/8	3/4	1 5/64
A-328	3/8	7/8	1 5/64
A-512	1/2	3/8	1 3/32
A-514	1/2	7/16	1 3/32
A-516	1/2	1/2	1 3/32
A-518	1/2	9/16	1 3/32
A-520	1/2	5/8	1 1/8
A-522	1/2	11/16	1 1/8
A-524	1/2	3/4	1 1/8
A-526	1/2	13/16	1 1/8
A-528	1/2	7/8	1 1/8
A-530	1/2	15/16	1 1/8
A-534	1/2	1 1/16	1 1/8
A-536	1/2	1 1/8	1 1/8
A-538	1/2	1 3/16	1 1/8
A-540	1/2	1 1/4	1 1/8

Sockets with Male Hex



Part Number	Female Square In.	Male Hex In.	Overall Length In.	mm
SJ-375	5/16	3/8	13/16	21
SJ-379	1/2	3/8	1	25
SJ-380	9/16	3/8	1	25
SJ-349	3/8	7/16	15/16	24
SJ-350	7/16	7/16	15/16	24
SJ-351	1/2	7/16	1	25
SJ-352	9/16	7/16	1	25
SJ-360	3/8	1/2	15/16	24
SJ-361	7/16	1/2	15/16	24
SJ-241	1/2	1/2	1	25
SJ-362	9/16	1/2	1	25
SJ-364	11/16	1/2	1 3/16	30
SJ-55	7/16	9/16	15/16	24
SJ-66	1/2	9/16	1	25
SJ-67	9/16	9/16	1	25
SJ-68	5/8	9/16	1 1/8	28

Socket & Ratchet Wrench Adapters, Metric



Part Number	Male Square In.	Male Hex mm	Overall Length In.	mm
A-1-6mm	1/4	6	25/32	20
A-1-7mm	1/4	7	25/32	20
A-1-8mm	1/4	8	25/32	20
A-1-9mm	1/4	9	25/32	20
A-1-10mm	1/4	10	25/32	20
A-1-11mm	1/4	11	25/32	20
A-1-12mm	1/4	12	25/32	20
A-1-13mm	1/4	13	25/32	20
A-3-10mm	3/8	10	15/16	24
A-3-11mm	3/8	11	15/16	24
A-3-12mm	3/8	12	15/16	24
A-3-13mm	3/8	13	15/16	24
A-3-14mm	3/8	14	15/16	24
A-3-15mm	3/8	15	15/16	24
A-3-16mm	3/8	16	15/16	24
A-3-17mm	3/8	17	15/16	24
A-3-18mm	3/8	18	15/16	24
A-3-19mm	3/8	19	15/16	24
A-5-10mm	1/2	10	1 1/8	29
A-5-11mm	1/2	11	1 1/8	29
A-5-12mm	1/2	12	1 1/8	29
A-5-13mm	1/2	13	1 1/8	29
A-5-14mm	1/2	14	1 1/8	29
A-5-15mm	1/2	15	1 1/8	29
A-5-16mm	1/2	16	1 1/8	29
A-5-17mm	1/2	17	1 1/8	29
A-5-18mm	1/2	18	1 1/8	29
A-5-19mm	1/2	19	1 1/8	29
A-5-20mm	1/2	20	1 1/8	29
A-5-21mm	1/2	21	1 1/8	29
A-5-22mm	1/2	22	1 1/8	29
A-5-23mm	1/2	23	1 1/8	29
A-5-24mm	1/2	24	1 1/8	29
A-5-25mm	1/2	25	1 1/8	29

Hex Drive Universal Adapters



Male Hex to Male Square - Extension

Part Number	Standard	Tension	Male Sq. In.	Male Hex In.	Type of Lock	Overall Length In.	mm	Largest Diameter In.	mm
-		KSM-25-3	1/4	1/4	Pin	3	76	5/8	15.9
KCM-25-B-6		KSM-25-B-6	1/4	1/4	Ball	6	152	5/8	15.9
KCM-37-6		KSM-37-6	3/8	1/4	Pin	6	152	3/4	19.1
-		KSM-37-B-6	3/8	1/4	Ball	6	152	3/4	19.1

Universal wrenches must not be used with impact drivers.
Maximum operating angle is 30°.-
Standard lengths are 3", 6", 9" and 12" (76, 152, 229 and 305mm).

Screwdriver Bit Quotation Worksheet

For quotation only. Not an order.

NAME _____ TITLE _____

COMPANY _____

ADDRESS _____ CITY _____ STATE _____ ZIP _____

E-MAIL _____ PHONE _____ FAX _____

Style	Point Size	Style	Point Size	Style	Point Size	Style	Point Size
<input type="checkbox"/> Phillips		<input type="checkbox"/> Torx®		<input type="checkbox"/> Frearson/Reed Prince		<input type="checkbox"/> Torx-Set®	
<input type="checkbox"/> Phillips ACR®		<input type="checkbox"/> Torx Plus®		<input type="checkbox"/> Socket Head		<input type="checkbox"/> Triple Square	
<input type="checkbox"/> Slotted		<input type="checkbox"/> Pozidriv®		<input type="checkbox"/> Square		<input type="checkbox"/> Tri-Wing	
						<input type="checkbox"/> Other _____	

Drive Type **Size**

Hex Insert

Hex Power

Threaded

Female Square

Other _____

Nylon Covers Requirements:

Components To Be Covered

- Bit only
- Bit and Bit Holder

Cover Features

- Flush with tip of bit
- Exposed tip of bit
- Retractable
- Embedded magnets
- Press fit
- Free-spinning (able to spin independently of part being covered)
- O.D. limitations (must specify) _____
- Other considerations (must specify) _____

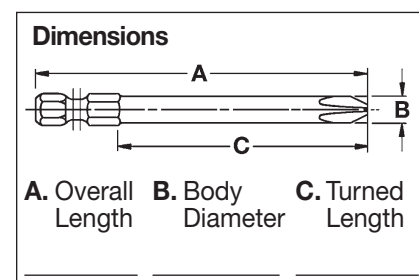

Bit Holder Styles For Hex Insert Bits

- Magnetic
- O-Ring Retention
- Standard (Retaining Groove)
- Quick Release
- Other _____

Bit Holder Drive Types **Size**

- Hex Drive _____
- Female Square _____
- Other _____

Additional Specifications _____

Quantity _____

Applied or Driving Torque _____

Sockets Quotation Worksheet

For quotation only. Not an order.

NAME _____ TITLE _____

COMPANY _____

ADDRESS _____ CITY _____ STATE _____ ZIP _____

E-MAIL _____ PHONE _____ FAX _____

Socket Type

Type A (tapered) Type B (straight) Type C (shouldered)

Broach Opening

- Hex Double Square Torx®
- Double Hex Fast Lead Other
- Square Surface Drive

Magnetic

- Magnetic Bolt Clearance (MB)
- Magnetic Bolt Clearance, with retaining ring (RMB)
- Strip Magnet (SM)
- Fixed Magnet (M)
- Non-magnetic

Drive Configuration

- DIN Standard
- No DIN groove
- Cross Hole (one wall only)

Extensions

- Hex Drive _____
- Female Square _____
- Other _____

Size

Extension Length

- No extension required

Quantity _____

Applied or Driving Torque _____

Dimensions

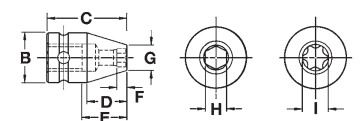

- A. Square drive _____
- B. Drive end diameter _____
- C. Overall length _____
- D. Taper or shoulder length _____
- E. Bolt clearance depth _____
- F. Broach depth _____
- G. Nose end diameter _____
- H. Broach opening _____
- I. Torx® size _____

Nylon Covers Requirements:

Components To Be Covered

- Socket only
- Socket and Extension

Cover Features

- Exposed tip of socket hex
- Recessed tip of socket hex
- Flush tip of socket hex
- Press fit
- Free-spinning (able to spin independently of part being covered)
- O.D. limitations (must specify) _____
- Other considerations (must specify) _____

Additional Specifications _____

Universal Wrench Quotation Worksheet

For quotation only. Not an order.

NAME _____		TITLE _____	
COMPANY _____			
ADDRESS _____	CITY _____	STATE _____	ZIP _____
E-MAIL _____	PHONE _____	FAX _____	

Dimensions

Female square drive, standard type

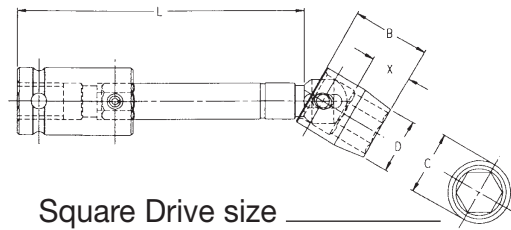

Square Drive size _____

Female square drive, tension type

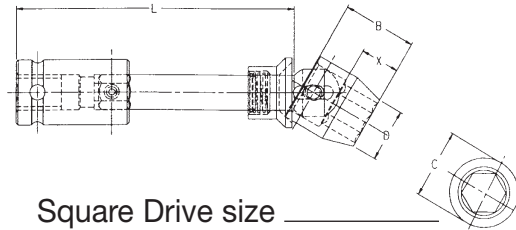

Square Drive size _____

Male hex drive, standard type

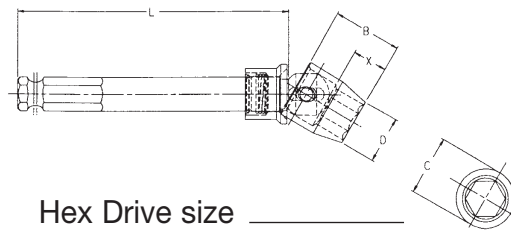

Hex Drive size _____

Male hex drive, tension type

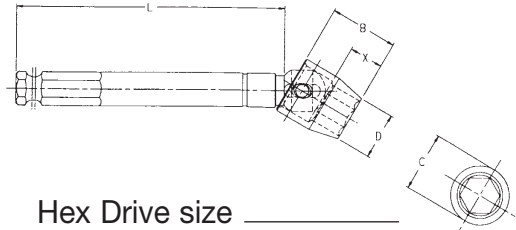

Hex Drive size _____

Female square drive, (short)

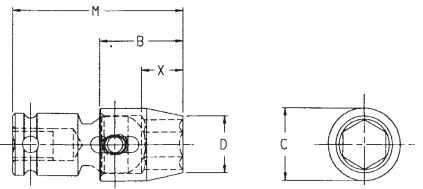

Square Drive size _____

B. Socket length _____ **C.** Socket diameter* _____

D. Socket nose dia. _____ **G.** Depth of Clearance _____

L. Shank length _____ **M.** Overall length _____

*Standard diameters are 5/8", 3/4", 7/8", 1", 1 1/4", 1 1/2", 1 3/4", 2"

Broach Opening Style & Size

Hex _____ Double Hex _____ Quantity _____

Male square _____ Pin lock _____ Ball lock _____ Hole _____ Applied or Driving Torque _____

Additional Specifications _____

Part Number Index

Part No.	Part No.	Part No.	Part No.	Part No.	Part No.	Part No.	Part No.
821.....3	5912.....52	7428.....62	8624.....66	1111.....35	13MM03.....44	16MM13-D.....44	185-10X.....17
852.....3	5914.....52	7430.....62	8632.....66	1111-D.....35	13MM03-D.....44	16MM15.....54	185-1XX.....17
1105.....35	5918.....52	7432.....62	8634.....66	1112.....35	13MM11.....37	16MM15-D.....54	185-2.5MM.....17
1112.....67	5920.....52	7436.....62	8636.....66	1112.....67	13MM11-D.....37	16MM16.....61	185-2MM.....17
1207.....35	6118.....60	7448.....62	8638.....66	1112-D.....35	13MM13.....44	16MM21.....37	185-2X.....17
1209.....35	6120.....60	7454.....62	8640.....66	1113.....35	13MM13-D.....44	16MM23.....44	185-3MM.....17
1213.....35	6122.....60	7456.....62	8644.....66	1114.....35	13MM15.....54	16MM23-D.....44	185-3X.....17
1311.....35	6124.....60	7536.....62	9172.....67	1114-D.....35	13MM15-D.....54	16MM43.....44	185-4-4X.....17
1313.....35	6128.....60	7548.....62	9172.....67	1116.....35	13MM21.....37	16MM43-D.....44	185-4MM.....17
1316.....35	6134.....60	7552.....62	1000000000.....36	1116-D.....35	13MM21-D.....37	16MM55.....55	185-4X.....17
1318.....35	6136.....60	7628.....63	5000000000.....51	1118.....35	13MM23.....44	16MM55-D.....55	185-5MM.....17
1320.....35	6140.....60	7630.....63	3E11.....42	1120.....35	13MM23-D.....44	170-0.....21	185-5X.....17
1612.....36	6142.....60	7632.....63	5E12.....51	11MM03.....44	13MM33.....44	170-1/2.....22	185-6MM.....17
3109.....40	6144.....60	8126.....65	3E14.....42	11MM03-D.....44	13MM43.....44	170-1/4.....22	185-6X.....17
3113.....40	6146.....60	8138.....65	5E16.....51	11MM11.....37	13MM43-D.....44	170-1/4A.....22	185-7MM.....17
3117.....40	6148.....60	8142.....65	10008S.....80	11MM11-D.....37	13MM55.....55	170-1/4-ACR.....22	185-7X.....17
3126.....40	6320.....60	8148.....65	10010S.....80	11MM13.....44	13MM55-D.....55	170-1/4B.....21	185-8MM.....17
3209.....40	6322.....60	8152.....65	10015S.....80	11MM13-D.....44	13MME1.....38	170-1.....21	185-8X.....17
3211.....40	6324.....60	8160.....65	10016S.....80	11MM15.....54	13MME3.....45	170-10.....21	185-9MM.....17
3308.....40	6326.....60	8162.....65	10017S.....80	11MM15-D.....54	14MM03.....44	170-10A.....22	185-9X.....17
3311.....40	6330.....60	8170.....65	10019S.....80	11MM21.....37	14MM03-D.....44	170-10-ACR.....21	18MM03.....44
3326.....40	6336.....60	8172.....65	10020S.....80	11MM23.....44	14MM11.....37	170-2.....21	18MM13.....44
3409.....40	6340.....60	8174.....65	10025S.....80	11MM23-D.....44	14MM11-D.....37	170-3/8.....22	18MM13-D.....44
3426.....40	6342.....60	8176.....65	10032S.....80	11MM43.....44	14MM13.....44	170-3/8A.....22	18MM15.....54
3432.....40	6344.....60	8180.....65	10034S.....80	11MM55.....55	14MM13-D.....44	170-3/8B.....21	18MM15-D.....54
3530.....40	6348.....60	8186.....65	103-00X.....8	11MME1.....38	14MM15.....54	170-3/8C.....22	18MM16.....61
3534.....40	6426.....60	8188.....65	103-1X.....8	1206.....35	14MM15-D.....54	170-3.....21	18MM17.....64
3607.....42	6430.....60	8190.....65	103-2X.....8	1206-D.....35	14MM21.....37	170-4.....21	18MM23.....44
3616.....42	6524.....60	8228.....65	103-3X.....8	1208.....35	14MM23.....44	170-5/16.....22	18MM23-D.....44
3618.....42	7122.....62	8236.....65	103-4X.....8	1208-D.....35	14MM23-D.....44	170-5/16A.....22	18MM43.....44
3620.....42	7128.....62	8240.....65	103-5X.....8	1209-D.....35	14MM43.....44	170-5/16-ACR.....22	18MM55.....55
3624.....42	7132.....62	8324.....65	103-6X.....8	1210.....35	14MM43-D.....44	170-5/16B.....21	18MM55-D.....55
5119.....49	7134.....62	8326.....65	10MM03.....44	1210-D.....35	14MM55.....55	170-5/8.....22	1950-0X.....20
5131.....49	7136.....62	8332.....65	10MM03-D.....44	1211.....35	14MM55-D.....55	170-5.....21	1950-1X.....20
5154.....49	7142.....62	8336.....65	10MM11.....37	1212.....35	1500-P.....28	170-6.....21	1950-2X.....20
5156.....49	7144.....62	8338.....65	10MM11-D.....37	1212-D.....35	1510-P.....28	170-6-ACR.....21	1950-3X.....20
5210.....49	7146.....62	8342.....65	10MM13.....44	1214.....35	15MM03.....44	170-7/16.....22	1951-0X.....20
5238.....49	7152.....62	8346.....65	10MM13-D.....44	1216.....35	15MM03-D.....44	170-7/16C.....22	1951-1X.....20
5240.....49	7154.....62	8356.....65	10MM15.....54	1216-D.....35	15MM11.....37	170-8.....21	1951-2X.....20
5242.....49	7156.....62	8360.....65	10MM15-D.....54	1218.....35	15MM13.....44	170-8A.....22	1951-3X.....20
5244.....49	7158.....62	8364.....65	10MM21.....37	12MM03.....44	15MM13-D.....44	170-8-ACR.....21	1953-1X.....20
5310.....49	7160.....62	8370.....65	10MM21-D.....37	12MM03-D.....44	15MM15.....54	170-9/16.....22	1953-2X.....20
5344.....49	7164.....62	8378.....65	10MM23.....44	12MM11.....37	15MM15-D.....54	17MM03.....44	1953-3X.....20
5348.....49	7168.....62	8380.....65	10MM23-D.....44	12MM11-D.....37	15MM21.....37	17MM13.....44	1956-2X.....20
5421.....49	7170.....62	8382.....65	10MM33.....44	12MM13.....44	15MM21-D.....37	17MM13-D.....44	19MM03.....44
5438.....49	7172.....62	8384.....65	10MM43.....44	12MM13-D.....44	15MM23.....44	17MM15.....54	19MM03-D.....44
5442.....49	7176.....62	8432.....65	10MM43-D.....44	12MM15.....54	15MM23-D.....44	17MM15-D.....54	19MM13.....44
5610.....52	7180.....62	8434.....65	10MM55.....55	12MM15-D.....54	15MM33.....44	17MM16.....61	19MM13-D.....44
5622.....52	7330.....62	8436.....65	10MM55-D.....55	12MM21.....37	15MM33-D.....44	17MM17.....64	19MM15.....54
5624.....52	7332.....62	8442.....65	10MME1.....38	12MM23.....44	15MM43.....44	17MM23.....44	19MM15-D.....54
5628.....52	7336.....62	8448.....65	10MME3.....45	12MM23-D.....44	15MM43-D.....44	17MM23-D.....44	19MM17.....64
5632.....52	7342.....62	8454.....65	1106.....35	12MM43.....44	15MM55.....55	17MM36.....61	19MM23.....44
5634.....52	7346.....62	8456.....65	1106-D.....35	12MM43-D.....44	15MM55-D.....55	17MM43.....44	19MM23-D.....44
5636.....52	7348.....62	8458.....65	1107.....35	12MM55.....55	15MME5.....56	17MM43-D.....44	19MM36.....61
5716.....52	7352.....62	8460.....65	1107-D.....35	12MM55-D.....55	1608.....36	17MM55.....55	19MM43.....44
5720.....52	7356.....62	8464.....65	1108.....35	12MME1.....38	1608-D.....36	17MM55-D.....55	19MM43-D.....44
5724.....52	7358.....62	8472.....65	1108-D.....35	1308.....35	1612-D.....36	185-000X.....17	19MM55.....55
5728.....52	7360.....62	8480.....65	1109.....35	1308-D.....35	16MM03.....44	185-00X.....17	1E08.....36
5812.....52	7362.....62	8530.....65	1109-D.....35	1310.....35	16MM03-D.....44	185-0X.....17	1P06.....36
5820.....52	7364.....62	8536.....65	1110.....35	1311-D.....35	16MM11.....37	185-1.5MM.....17	1P08.....36
5822.....52	7372.....62	8542.....65	1110-D.....35	1312.....35	16MM13.....44	185-10MM.....17	1P10.....36

Part Number Index

Part No.	Part No.	Part No.	Part No.	Part No.	Part No.	Part No.	Part No.
1P11.....36	24MM18.....66	273B-6.....21	3111.....40	3228-D.....40	328-5X.....7	3516.....41	440-215X.....1
1P12.....36	24MM36.....61	273B-8.....21	3112.....40	322-MX.....9	328-6X.....7	3516-D.....40	440-225-SFX.....14
1P14.....36	24MM37.....64	27MM15.....54	3112-D.....40	322-OLX.....9	328-LX.....9	3518.....41	440-225X.....1
1P16.....36	24MM38.....66	27MM15-D.....54	3113-D.....40	322-000LX.....9	328-MX.....9	3518-D.....40	440-22-ACR2-DX.....1
20MM03.....44	24MM47.....64	27MM17.....64	3114.....40	323-000X.....7	328-PX.....9	3524.....40	440-22-ACR2-RX.....1
20MM15.....54	24MM55.....65	27MM18.....66	3114-D.....40	323-00X.....7	328-RX.....9	3524-D.....40	440-22-ACR2X.....1
20MM17.....64	24MM55-D.....55	27MM37.....64	3116.....40	323-0X.....7	328-SX.....9	3532.....40	440-22-PZDX.....13
212-0.....21	24MM57.....64	27MM38.....66	3116-D.....40	323-1X.....7	32MM17.....64	3608.....42	440-22-SFX.....14
212-1/4.....21	25MM15.....54	27MM47.....64	3118.....40	323-20X.....7	32MM18.....66	3609.....42	440-22X.....1
212-1/4A.....21	25MM37.....64	27MM55.....55	3119.....40	323-2X.....7	32MM37.....64	3609-D.....42	440-23X.....1
212-1/4A-ACR.....21	265-0.....21	27MM55-D.....55	3120.....40	323-3X.....7	32MM47.....64	3610.....42	440-24X.....1
212-1.....21	265-1.....21	27MM57.....64	3120-D.....40	323-4X.....7	32MM55.....55	3610-D.....42	440-255X.....1
212-10.....21	265-1/4.....22	28MM15.....54	3122.....40	323-5X.....7	3310.....40	3612.....40	440-25IPRX.....12
212-10A.....21	265-10.....21	28MM25.....54	3124.....40	323-6X.....7	3310-D.....40	3612-D.....42	440-25IPX.....12
212-2.....21	265-2.....21	28MM37.....64	3124-D.....40	324-000X.....7	3312.....40	3614.....42	440-26X.....1
212-3/8A.....21	265-3.....21	28MM37.....64	315-10MM.....17	324-00X.....7	3312-D.....40	3614-D.....42	440-27IPRX.....12
212-3.....21	265-4.....21	28MM38.....66	315-12MM.....17	324-0X.....7	3314.....40	3616-D.....42	440-27IPX.....12
212-4.....21	265-5/16.....22	28MM38.....66	315-14MM.....17	324-1X.....7	3314-D.....40	3618-D.....42	440-27X.....1
212-5/16A.....21	265-5.....21	29MM17.....64	315-2.5MM.....17	324-20X.....7	3316.....40	36MM17.....64	440-2-ACR2-DX.....1
212-5/16A-ACR.....21	265-6.....21	29MM18.....66	315-3X.....17	324-2X.....7	3316-D.....40	36MM18.....66	440-2-ACR2-RI.....1
212-5.....21	265-8.....21	29MM37.....64	315-4MM.....17	324-3X.....7	3318.....40	36MM37.....64	440-2-ACR2-RX.....1
212-6.....21	265A-0.....21	29MM55.....55	315-4X.....17	324-4X.....7	3318-D.....40	36MM38.....66	440-2-ACR2X.....1
212-8.....21	265A-1.....21	3.5MM11.....37	315-5MM.....17	324-5X.....7	3320.....40	37MM17.....64	440-2I.....1
212-8A.....21	265A-1/4.....22	3.5MME1.....38	315-5X.....17	324-6X.....7	3320-D.....40	37MM38.....66	440-2-PZDX.....13
21MM03.....44	265A-10.....21	3010.....40	315-6MM.....17	324-000X.....7	3322.....40	3E10.....40	440-2-SFX.....14
21MM13.....44	265A-2.....21	3012.....40	315-6X.....17	325-00X.....7	3322-D.....40	3E12.....42	440-2X.....1
21MM15.....54	265A-3.....21	3012-D.....40	315-7MM.....17	325-0X.....7	3324.....40	3E16.....42	440-30IPRX.....12
21MM15-D.....54	265A-3/8.....22	3014.....40	315-7X.....17	325-1X.....7	3324-D.....40	3P10.....42	440-30IPX.....12
21MM16.....61	265A-4.....21	3014-D.....40	315-8MM.....17	325-20X.....7	3326-D.....40	3P12.....42	440-3125X.....1
21MM17.....64	265A-5.....21	3016.....40	315-8X.....17	325-3X.....7	3328.....40	3P14.....42	440-40IPX.....12
21MM18.....66	265A-5/16.....22	3016-D.....40	320-000X.....7	325-4X.....7	33MM17.....64	3P16.....42	440-325X.....1
21MM23.....44	265A-6.....21	3018.....40	320-00X.....7	325-5X.....7	33MM37.....64	4.5MM11.....37	440-33X.....1
21MM36.....61	265A-7/16.....22	3018-D.....40	320-0X.....7	325-6X.....7	33MM38.....66	400-BH.....25	440-34X.....1
21MM37.....64	265A-8.....21	3020.....40	320-1X.....7	326-000X.....7	3408.....40	401-PZDX.....13	440-3-ACR3-DX.....1
21MM55.....55	26MM15.....54	3020-D.....40	320-20X.....7	326-00X.....7	3408-D.....40	401X.....3	440-3-ACR3-RX.....1
21MM55-D.....55	26MM15-D.....54	3022.....40	320-2X.....7	326-0X.....7	3410.....40	402-PZDX.....13	440-3-ACR3X.....1
21MM57.....64	26MM17.....64	3022-D.....40	320-3X.....7	326-1X.....7	3410-D.....40	402X.....3	440-3BNX.....1
21-S-156-0375.....26	26MM55.....55	3024.....40	320-4X.....7	326-20X.....7	3412.....40	403-PZDX.....13	440-3I.....1
21-S-156-0750.....26	273-0.....21	3024-D.....40	320-5X.....7	326-2X.....7	3412-D.....40	403X.....3	440-3-PZDX.....13
21-S-156-0937.....26	273-1.....21	3028.....40	320-6X.....7	326-3X.....7	3414.....40	41MM17.....64	440-3-SFX.....14
21-S-187-1125.....26	273-10.....21	3028-D.....40	3208.....40	326-4X.....7	3414-D.....40	41MM18.....66	440-3X.....1
21-S-187-1375.....26	273-2.....21	309-000X.....8	3208-D.....40	326-5X.....7	3416.....40	41MM37.....64	440-40IPRX.....12
21-S-187-1500.....26	273-3.....21	309-00X.....8	3210.....40	326-6X.....7	3416-D.....40	42MM18.....66	440-40IPX.....12
21-S-187-1625.....26	273-4.....21	309-1X.....8	3210-D.....40	327-000X.....7	3418.....40	440-10IPRX.....12	440-4-PZDX.....13
22MM03.....44	273-5.....21	309-2X.....8	3212.....40	327-00X.....7	3418-D.....40	440-10IPX.....12	440-4X.....1
22MM13.....44	273-6.....21	309-3X.....8	3212-D.....40	327-0X.....7	3420.....40	440-115X.....1	440-FX.....15
22MM15.....54	273-8.....21	309-4X.....8	3214.....40	327-1X.....7	3420-D.....40	440-125X.....1	440-MT-0.....22
22MM15-D.....54	273A-1.....21	309-5X.....8	3214-D.....40	327-20X.....7	3424.....40	440-12X.....1	440-MT-00.....22
22MM17.....64	273A-10.....21	309-6X.....8	3216.....40	327-2X.....7	3424-D.....40	440-13X.....1	440-MT-1.....22
22MM23.....44	273A-2.....21	309-8X.....8	3216-D.....40	327-3X.....7	3428.....40	440-15IPRX.....12	440-MT-2.....22
22MM47.....64	273A-3.....21	30MM17.....64	3218.....40	327-4X.....7	3430.....40	440-15IPX.....12	440-TSQ-10M.....23
22MM55.....55	273A-4.....21	30MM18.....66	3218-D.....40	327-5X.....7	3430-D.....40	440-1-ACR1-DX.....1	440-TSQ-4M.....23
22MM55-D.....55	273A-6.....21	30MM37.....64	3220.....40	327-6X.....7	3434.....40	440-1-ACR1-RX.....1	440-TSQ-5M.....23
22MM57.....64	273A-8.....21	30MM47.....64	3220-D.....40	328-000X.....7	34MM18.....66	440-1-ACR1X.....1	440-TSQ-6M.....23
23MM15.....54	273B-0.....21	30MM48.....66	3222.....40	328-00X.....7	34MM37.....64	440-1-PZDX.....13	440-TSQ-8M.....23
23MM15-D.....54	273B-1.....21	30MM55.....55	3222-D.....40	328-0X.....7	3510.....41	440-1-SFX.....14	440-TSQ-8M.....23
24 Bit Kit.....53	273B-10.....21	30MM57.....64	3224.....40	328-1X.....7	3511.....40	440-1X.....1	440-TX-06X.....10
24MM15.....54	273B-2.....21	3108.....40	3224-D.....40	328-20X.....7	3512.....41	440-20IPRX.....12	440-TX-07-H.....10
24MM15-D.....54	273B-3.....21	3108-D.....40	3226.....40	328-2X.....7	3512-D.....40	440-20IPX.....12	440-TX-07X.....10
24MM16.....61	273B-4.....21	3110.....40	3226-D.....40	328-3X.....7	3514.....41	440-215-PZDX.....13	440-TX-08-H.....10
24MM17.....64	273B-5.....21	3110-D.....40	3228.....40	328-4X.....7	3514-D.....41	440-215-SFX.....14	440-TX-08X.....10

Part Number Index

Part No.	Part No.	Part No.	Part No.	Part No.	Part No.	Part No.	Part No.
440-TX-09-H.....10	446-2I.....1	485-1X.....7	492-A-ACR2X.....2	49-A-TX-15.....11	49-TX-20-5.....11	5144.....49	5420-D.....49
440-TX-09X.....10	446-2-PZDX.....13	485-2X.....7	492-ACR2-DX.....2	49-A-TX-15-H.....11	49-TX-20-W.....11	5144-D.....49	5421-D.....49
440-TX-10-H.....10	446-2-SFX.....14	485-3X.....7	492-ACR2-RX.....2	49-A-TX-15-W.....11	49-TX-25.....11	5146.....49	5422.....49
440-TX-10-W.....10	446-2X.....1	485-4X.....7	492-ACR2X.....2	49-A-TX-20.....11	49-TX-25-W.....11	5148.....49	5422-D.....49
440-TX-10X.....10	446-FX.....15	485-5X.....7	492-AFX.....15	49-A-TX-20-H.....11	49-TX-27.....11	5148-D.....49	5424.....49
440-TX-15-125.....10	451X.....2	485-6X.....7	492-AI.....15	49-A-TX-20-H.....11	49-TX-27-W.....11	5152.....49	5424-D.....49
440-TX-15-H.....10	452X.....2	485-7X.....7	492-A-PZDX.....13	49-A-TX-25.....11	49-TX-30.....11	5152-D.....49	5426.....49
440-TX-15-W.....10	453X.....2	488.....25	492-A-SFX.....14	49-A-TX-30.....11	49-TX-30-W.....11	5212.....49	5426-D.....49
440-TX-15X.....10	460.....25	48-TSQ-10M.....23	492-AX.....2	49-A-TX-40.....11	49-TX-40.....11	5214.....49	5428.....49
440-TX-20-125.....10	46MM17.....64	48-TSQ-12M.....23	492-B-27X.....2	49-B-10IPX.....12	4MM11.....37	5216.....49	5430.....49
440-TX-20-2.....10	46MM18.....66	48-TSQ-14M.....23	492-B-ACR2-DX.....2	49-B-15IPX.....12	4MME1.....38	5216-D.....49	5430-D.....49
440-TX-20-H.....10	46MM38.....66	48-TSQ-5M.....23	492-B-ACR2X.....2	49-B-20IPX.....12	5.5MM11.....37	5218.....49	5432.....49
440-TX-20-W.....10	480.....25	48-TSQ-6M.....23	492-BFX.....15	49-B-25IPX.....12	5.5MM21.....37	5218-D.....49	5432-D.....49
440-TX-20X.....10	480-1-PZDX.....13	48-TSQ-8M.....23	492-BI.....2	49-B-27IPX.....12	5.5MME1.....38	5220.....49	5434.....49
440-TX-25-H.....10	480-1X.....1	48-TX-45.....11	492-B-PZDX.....13	49-B-30IPX.....12	501-AX.....3	5222.....49	5434-D.....49
440-TX-25-W.....10	480-225X.....1	48-TX-50.....11	492-B-SFX.....14	49-B-30IPX.....12	501X.....3	5224.....49	5436.....49
440-TX-25X.....10	480-22X.....1	48-TX-55.....11	492-BX.....2	49-B-TX-05.....11	502-ACR2X.....3	5224-D.....49	5436-D.....49
440-TX-27-H.....10	480-24X.....1	490.....25	492-C-27X.....2	49-B-TX-07.....11	502-AX.....3	5226.....49	5440.....49
440-TX-27-W.....10	480-24X.....1	490-10.....25	492-C-ACR2-DX.....2	49-B-TX-08.....11	502-PZDX.....13	5226-D.....49	5440-D.....49
440-TX-27X.....10	480-2-ACR2-RX.....1	490-3.....25	492-C-ACR2X.....1	49-B-TX-09.....11	502X.....3	5228.....49	5510.....50
440-TX-30-H.....10	480-2-ACR2X.....1	490-4.....25	492-C-CCX.....2	49-B-TX-10.....11	503X.....3	5228-D.....49	5512.....50
440-TX-30-W.....10	480-2-PZDX.....13	490-5.....25	492-CFX.....15	49-B-TX-15.....11	50MM18.....66	5230.....49	5512-D.....50
440-TX-30X.....10	480-2-SFX.....14	490-6.....25	492-CI.....2	49-B-TX-15-H.....11	50MM38.....66	5230-D.....49	5514.....50
440-TX-40-H.....10	480-2X.....1	490-6.....25	492-CI.....2	49-B-TX-15-W.....11	50MM38.....66	5230-D.....49	5514-D.....50
440-TX-40-W.....10	480-30IPX.....12	490-8.....25	492-C-PZDX.....13	49-B-TX-20.....11	50-TX-08.....12	5232.....49	5514-D.....50
440-TX-40X.....10	480-325X.....1	4910-AX.....2	492-C-SFX.....14	49-B-TX-20-H.....11	50-TX-10.....12	5234.....49	5516.....50
440-TX-45X.....10	480-34X.....1	4910-BX.....2	492-CX.....2	49-B-TX-20-W.....11	50-TX-15.....12	5236.....49	5516-D.....50
440-TX-50X.....10	480-3-ACR3X.....1	4910-CX.....2	492-CX.....2	49-B-TX-25.....11	50-TX-20.....12	5236-D.....49	5518.....50
445-000X.....7	480-3-ACR3X.....1	4910-CX.....2	492-FX.....15	49-B-TX-27.....11	5108.....49	5240-D.....49	5518-D.....50
445-00-15X.....7	480-3-PZDX.....13	49-10IPRX.....13	492I.....2	49-B-TX-30.....11	5110.....49	5240-D.....49	5518-D.....50
445-00X.....7	480-3X.....1	49-10IPX.....12	492-PZDX.....13	49-B-TX-30-W.....11	5110-D.....49	5248.....49	551X.....3
445-0-15X.....7	480-40IPX.....12	4910X.....2	492-SFX.....14	49-B-TX-30-W.....11	5110-D.....49	5312.....49	5520.....50
445-0-15X.....7	480-425X.....1	49-15IPRX.....13	492-SFX.....14	49-B-TX-40.....11	5112.....49	5314.....49	5520-D.....50
445-00X.....7	480-45IPX.....12	49-15IPX.....12	4930-AX.....2	49-C-TX-07.....11	5112-D.....49	5316.....49	5522.....50
445-0-15X.....7	480-4-ACR4X.....1	491-ACR1-DX.....5	4930-BX.....2	49-C-TX-08.....11	5114.....49	5316-D.....49	5522-D.....50
445-0X.....7	480-4BNX.....1	491-ACR1-RX.....5	4930-CCX.....2	49-C-TX-09.....11	5114-D.....49	5318.....49	5524.....50
445-10-15X.....7	480-4X.....1	491-ACR1X.....2	4930-CX.....2	49-C-TX-10.....11	5116.....49	5318-D.....49	5524-D.....50
445-10X.....7	480-50IPX.....12	491-AFX.....15	4930-CX.....2	49-C-TX-15.....11	5116-D.....49	5320.....49	5526.....50
445-1-15X.....7	480-55IPX.....12	491-A-PZDX.....13	49-30IPRX.....12	49-C-TX-20.....11	5118.....49	5322.....49	5526-D.....50
445-20-15X.....7	480-FX.....15	491-A-SFX.....14	4930X.....2	49-C-TX-20-H.....11	5118-D.....49	5322-D.....49	5528.....50
445-20X.....7	480-MT-3.....22	491-AX.....2	493-ACR3X.....2	49-C-TX-25.....11	5120.....49	5324.....49	5528-D.....50
445-2-15X.....7	480-TSQ-10M.....23	491-BFX.....15	493-A-PZDX.....13	49-C-TX-27.....11	5120-D.....49	5324-D.....49	552-FX.....15
445-2X.....7	480-TSQ-12M.....						

Part Number Index

Part No.	Part No.	Part No.	Part No.	Part No.	Part No.	Part No.	Part No.
5616-D	6N-0810-4	7324SKT	833	954-B-3X	A-516	AM-6MM	BNAE-4MM
5618	6N-0810-5	7328	833-F	954-C-0X	A-5-16MM	AM-6MM-4	BNAE-4MM-ACR
5618-D	6N-0810-6	7330-D	834	954-C-1X	A-5-17MM	AM-7MM	BNAE-5MM
5620	6N-08-10M-3	7332-D	8340	954-C-2X	A-518	AM-8MM	BNAE-5MM-ACR
5620-D	6N-08-10M-4	7334	834-F	954-C-3X	A-5-18MM	AM-MT-0	BNAE-6MM
5624-D	6N-08-10M-6	7336-D	834-TX-25	95-A-QD-2	A-5-19MM	AM-MT-1	BNAE-6MM-ACR
5626	6N-0811-2	7340	834-TX30-1.62	95-B-QD-2	A-520	AM-MT-2	BNAE-8MM
5636-D	6N-0811-3	7424	834-TX40-2.95	95-QD-2	A-5-20MM	AN-04	BW-848
5724-D	6N-0812-2	7424-D	834-TX-45-5	95-QD-3	A-5-21MM	AN-04-A	BW-848-F
5816-D	6N-0812-3	7426	834-TX-50	9MM11	A-522	AN-05	BW-8626
5820-D	6N-0812-4	7428-D	834-TX50-1.62	9MM11-D	A-5-22MM	AN-05-6	BZCNC-30
5822-D	6N-0812-6	7430-D	835	9MM13	A-5-23MM	AN-06	BZCNC-31
5826-D	6N-08-12M-3	7434	835	9MM13-D	A-524	AN-06-6	CMS-1408
5832-D	6N-08-12M-4	7438	8430-D	9MM21	A-5-24MM	AN-07	CMS-1409
5834-D	6N-08-12M-6	7442	8432-D	9MM21-D	A-5-25MM	AN-07-8	CMS-1410
5836-D	6N-0814-2	7442-D	8440	9MM23	A-526	AN-08	CMS-1412
5912-D	6N-0814-3	7446	8440-D	9MM23-D	A-528	AN-08-8	CMS-1414
5914-D	6N-0814-4	7524	8442-D	9MM43	A-530	AN-09	CMS-1507
5918-D	6N-0814-6	7528	8444-D	9MM43-D	A-534	AN-10	CMS-1508
591-PZDX	6N-0816-2	7530	8448-D	9MME1	A-536	AN-10-6	CMS-1509
591X	6N-0816-3	7530-D	850	A-108	A-538	AN-10MM	CMS-1510
592-PZDX	6N-0818-2	7536-D	853	A-110	A-540	AN-12	CMS-3412
592X	6N-08-8M-3	7540	854	A-1-10MM	AM-01-A	AN-12-6	CMS-3414
5MM11	6N-08-8M-4	7542	8540	A-1-11MM	AM-02	AN-12MM	CMS-3416
5MM21	6N-08-8M-6	7556	854-TX-50	A-112	AM-02-A	AN-14MM	CMS-3418
5P12	6N-1410-3	7624	854-TX55-150M	A-1-12MM	AM-03	AN-14MM-6	CMS-3420
5P14	6N-1412-3	7636	855	A-1-13MM	AM-03-3	AN-16	CMS-3512
6120-D	6N-1414-3	7MM03	858	A-114	AM-03-6	AN-16-6	CMS-3518
635-10X	6N-1416-3	7MM11	8638-D	A-116	AM-03-A	AN-3MM	CMS-5416
635-6X	6N-1416-4	7MM11-D	8640-D	A-118	AM-04	AN-4MM	CMS-5422
635-7X	6N-1418-3	7MM13	8646-D	A-120	AM-04-3	AN-5MM	CMS-5426
635-8X	6N-1418-6	7MM21	8648	A-1-6MM	AM-04-35	AN-6MM	CMS-5430
635-9X	6N-1420-3	7MM23	8652-D	A-1-7MM	AM-04-4	AN-8MM	DB-08
638	6N-1424-3	7MM43	8MM03	A-1-8MM	AM-04-5	AN-MT-3	DB-10
6520-D	6N-1424-6	7MM43-D	8MM11	A-1-9MM	AM-04-6	AN-MT-4	DB-12
6524-D	6N-2028-4	7MME1	8MM11-D	A-3-10MM	AM-04-A	AP-08	EX-1000
6528-D	6N-2036-4	8124-D	8MM13	A-3-11MM	AM-04-A-4	AP-10	EX-1000-B
6B-0808	7120	8128-D	8MM13-D	A-312	AM-05	AP-12	EX-1001
6B-0809	7120-D	8130-D	8MM21	A-3-12MM	AM-05-3	AP-16	EX-1001-B
6B-0810	7122-D	8132-D	8MM21-D	A-3-13MM	AM-05-35	AP-18	EX-1003-10
6B-0811	7124	8134-D	8MM23	A-314	AM-05-4	AP-20	EX-1003-12
6B-0812	7124-D	8136-D	8MM23-D	A-3-14MM	AM-05-5	AP-24	EX-1003-15
6B-0814	7128-D	8138-D	8MM43	A-3-15MM	AM-05-6	APH35M	EX-1003-4
6B-0816	7130	8140-D	8MM43-D	A-316	AM-05-8	APH38	EX-1003-6
6B-0818	7130-D	8142-D	8MME1	A-3-16MM	AM-06	APH56	EX-1003-8
6B-0820	7132-D	8144-D	8MME3	A-3-17MM	AM-06-3	APH56M	EX-1003-B-10
6MM11	7134-D	8146-D	950-0X	A-318	AM-06-4	AP3312LM	EX-1003-B-12
6MM11-D	7136-D	8148-D	950-1X	A-3-18MM	AM-06-6	AP3312M	EX-1003-B-15
6MM13	7140	8150-D	950-2X	A-3-19MM	AM-07	AP38	EX-1003-B-4
6MM21	7140-D	8162-D	950-3X	A-320	AM-08	AP38L	EX-1003-B-6
6MM43	7142-D	820	950-QD-2	A-322	AM-1.5MM	AP3511M	EX-1003-B-8
6MME1	7148	822	954-0X	A-324	AM-10	AP38X	EX-1005
6N-0806-2	7148-D	822-F	954-1X	A-328	AM-10MM	APU37	EX-1005
6N-0806-3	7152-D	825	954-2X	A-5-10MM	AM-2.5MM	APU37M	EX-1005-B
6N-0808-2	7154-D	830	954-3X	A-5-11MM	AM-2MM	APU56	EX-1005-B
6N-0808-3	7160-D	830-1X	954-A-0X	A-512	AM-3MM	APU56M	EX-1101
6N-0808-4	7164-D	830-2X	954-A-1X	A-5-12MM	AM-3MM-3	AS-12	EX-250
6N-0808-5	7170-D	830-3X	954-A-2X	A-5-13MM	AM-3MM-4	AW-95	EX-250-12
6N-0808-6	7172-D	830-4X	954-A-3X	A-514	AM-4MM	AW-95-L	EX-250-2
6N-0810-2	7180-D	832	954-B-1X	A-5-14MM	AM-5MM	AW-95-LL	EX-250-3
6N-0810-3	7324-D	832-F	954-B-2X	A-5-15MM	AM-5MM-4	BNAE-3MM	EX-250-4

Part Number Index

Part No.	Part No.	Part No.	Part No.	Part No.	Part No.	Part No.	Part No.
EX-250-5	EX-370-B-10	EX-377-B-9	EX-508-3	EX-752-B	FL-3316	HTN-B-3	KB-320-6
EX-250-6	EX-370-B-2	EX-380	EX-508-4	EX-753	FL-3318	HTN-B-4	KB-321-6
EX-250-8	EX-370-B-3	EX-380-2	EX-508-5	EX-753-B	FL-3320	HTS-0	KB-322-3
EX-250-B	EX-370-B-4	EX-380-3	EX-508-6	EX-754	FL-3324	HTS-1	KB-322-6
EX-250-B-12	EX-370-B-6	EX-380-4	EX-508-8	EX-754-B	FL-3326	HTS-10	KB-43-6
EX-250-B-2	EX-370-B-8	EX-380-6	EX-508-9	EX-755-10	FL-3410	HTS-12	KB-45-3
EX-250-B-3	EX-371	EX-380-B	EX-508-B-10	EX-755-12	FL-3412	HTS-2	KB-45-4
EX-250-B-4	EX-371-10	EX-380-B-2	EX-508-B-12	EX-755-15	FL-3414	HTS-3	KB-6-10M-6
EX-250-B-5	EX-371-12	EX-500-2	EX-508-B-15	EX-755-4	FL-5114	HTS-3A	KB-7-11M-6
EX-250-B-6	EX-371-15	EX-500-3	EX-508-B-2	EX-755-6	FL-5116	HTS-4	KB-7-13M-12
EX-250-B-8	EX-371-2/3/4	EX-500-4	EX-508-B-3	EX-755-8	FL-5118	HTS-4A	KB-7-13M-3
EX-251	EX-371-2	EX-500-6	EX-508-B-4	EX-755-B-12	FL-5120	HTS-5	KB-7-13M-6
EX-251-10	EX-371-3	EX-500-B-2	EX-508-B-5	EX-755-B-15	FL-5122	HTS-6	KB-7-13M-9
EX-251-2	EX-371-4	EX-500-B-3	EX-508-B-6	EX-755-B-4	FL-5124	HTS-7	KB-7-14M-6
EX-251-3	EX-371-5	EX-500-B-4	EX-508-B-8	EX-755-B-6	FL-5126	HTS-8	KB-8-15M-12
EX-251-6	EX-371-6	EX-500-B-6	EX-508-B-9	EX-755-B-8	FL-5128	HTS-9	KB-8-15M-6
EX-251-8	EX-371-8	EX-501-10	EX-509-10	EX-756-4	FL-5130	KA-103-6	KB-8-15M-9
EX-251-B	EX-371-B-3	EX-501-12	EX-509-12	EX-756-6	FL-5132	KA-104-9	KB-8-16M-6
EX-251-B-2	EX-372	EX-501-15	EX-509-3	EX-756-8	FL-5134	KA-105-3	KB-8-16M-9
EX-252	EX-372-B	EX-501-2	EX-509-4	EX-757-3	FL-5216	KA-105-4	KB-8-17M-12
EX-252-B	EX-374	EX-501-3	EX-509-5	EX-757-B-3	FL-5218	KA-105-6	KB-8-18M-6
EX-254	EX-374-B	EX-501-4	EX-509-6	EX-758-4	FL-5222	KA-105-9	KC-101-6
EX-254-B	EX-375	EX-501-5	EX-510-3	EX-758-6	FL-5224	KA-205-3	KC-105-6
EX-255-10	EX-375-B	EX-501-6	EX-510-4	EX-758-9	FL-5226	KA-43-6	KC-25-12
EX-255-12	EX-376-10	EX-501-8	EX-510-6	EX-758-B-4	FL-5228	KA-44-3	KC-25-3
EX-255-14	EX-376-12	EX-501-B-10	EX-510-8	EXL-1000	FL-5316	KA-44-4	KC-25-4
EX-255-2	EX-376-15	EX-501-B-12	EX-510-B-3	EXL-1100	FL-5318	KA-44-6	KC-25-6
EX-255-3	EX-376-18	EX-501-B-2	EX-510-B-4	EXL-15	FL-5320	KA-45-3	KC-25-9
EX-255-4	EX-376-2	EX-501-B-3	EX-510-B-5	FC-310	FL-5324	KA-45-4	KC-26-12
EX-255-6	EX-376-3	EX-501-B-4	EX-510-B-6	FC-312	FL-5326	KA-45-6	KC-26-3
EX-255-8	EX-376-4	EX-501-B-5	EX-510-B-8	FL-1108	FL-5416	KA-45-9	KC-26-6
EX-255-B-2	EX-376-5	EX-501-B-6	EX-512-2	FL-1109	FL-5418	KA-6-10M-4	KC-26-9
EX-255-B-4	EX-376-6	EX-501-B-8	EX-512-3	FL-1110	FL-6124	KA-6-10M-6	KC-27-3
EX-255-B-6	EX-376-8	EX-502	EX-512-B-2	FL-1112	FL-6128	KA-6-10M-9	KC-27-6
EX-257-2	EX-376-9	EX-502-3	EX-512-B-4	FL-1114	FL-6324	KA-7-11M-12	KC-28-3
EX-257-3	EX-376-B-10	EX-502-5	EX-620-3	FL-1116	FL-SH-335	KA-7-12M-12	KC-28-6
EX-257-4	EX-376-B-12	EX-502-6	EX-620-6	FL-1212	FL-SW-493	KA-7-12M-4	KC-29-3
EX-257-5	EX-376-B-15	EX-502-8	EX-621-3	FL-1214	HA-510	KA-7-12M-6	KC-29-6
EX-257-6	EX-376-B-2	EX-502-B	EX-621-6	FL-1216	HC-100-1/2	KA-7-12M-9	KC-30-3
EX-257-B-2	EX-376-B-3	EX-502-B-3	EX-621-8	FL-3012	HC-100-1/4	KA-7-13M-12	KC-30-4
EX-257-B-3	EX-376-B-4	EX-502-B-4	EX-621-B-3	FL-3014	HC-100-10	KA-7-13M-3	KC-30-6
EX-257-B-4	EX-376-B-5	EX-503	EX-622	FL-3016	HC-100-3/4	KA-7-13M-4	KC-30-9
EX-257-B-5	EX-376-B-6	EX-503-B	EX-623	FL-3018	HC-100-3/8 FS	KA-7-13M-6	KC-31-3
EX-257-B-6	EX-376-B-8	EX-504	EX-623-B	FL-3022	HC-100-5/16	KA-7-13M-9	KC-5-7M-6
EX-258-4	EX-376-B-9	EX-504-B	EX-624	FL-3024	HC-100-5/8	KA-7-14M-6	KC-6-10M-12
EX-258-B-2	EX-377-10	EX-505	EX-624-B	FL-3110	HC-100-7/16	KA-8-15M-12	KC-6-10M-3
EX-260	EX-377-12	EX-506-B	EX-625	FL-3112	HC-3520	KA-8-15M-3	KC-6-10M-4
EX-260-B	EX-377-15	EX-506-B	EX-625-B	FL-3114	HC-3816	KA-8-15M-9	KC-6-10M-6
EX-262	EX-377-2	EX-507-2	EX-626-3	FL-3116	HE-100-1/2	KAM-37-3	KC-6-10M-9
EX-262-4	EX-377-3	EX-507-3	EX-627-10	FL-3118	HE-100-1/4	KAM-38-6	KC-6-8M-3
EX-262-6	EX-377-4	EX-507-4	EX-627-12	FL-3120	HE-100-3/4	KB-10-19M-6	KC-6-8M-4
EX-262-B-4	EX-377-5	EX-507-6	EX-627-3	FL-3122	HE-100-3/8 FS	KB-104-6	KC-6-8M-6
EX-370	EX-377-6	EX-507-B-3	EX-627-4	FL-3124	HE-100-5/16	KB-105-3	KC-6-9M-6
EX-370-10	EX-377-8	EX-507-B-4	EX-627-6	FL-3210	HE-100-5/8	KB-202-12	KC-7-11M-6
EX-370-2	EX-377-B-10	EX-507-B-6	EX-627-8	FL-3212	HE-100-7/16	KB-202-6	KC-7-12M-3
EX-370-3	EX-377-B-12	EX-508-10	EX-628-3	FL-3214	HE-1028	KB-203-12	KC-7-12M-6
EX-370-4	EX-377-B-2	EX-508-12	EX-750	FL-3216	HE-1028-D	KB-203-9	KC-7-12M-9
EX-370-5	EX-377-B-3	EX-508-15	EX-750-B	FL-3218	HE-530	KB-205-12	KC-7-13M-3
EX-370-6	EX-377-B-4	EX-508-16	EX-751	FL-3220	HT-848	KB-205-6	KC-7-13M-6
EX-370-8	EX-377-B-5	EX-508-18	EX-751-B	FL-3312	HTN-B-1	KB-317-9	KC-7-13M-9
EX-370-B	EX-377-B-6	EX-508-2	EX-752	FL-3314	HTN-B-2	KB-318-12	KCM-25-B-6

Part Number Index

Part No.	Part No.	Part No.	Part No.	Part No.	Part No.	Part No.	Part No.
KCM-37-6	KH-7-13M-9	KN-43-9	KS-6-8M-9	M-1107	M-17MM15	M3E18	M-610
KD-103-6	KH-7-14M-6	KN-44-6	KS-7-11M-6	M-1108-E	M-18MM03	M3P06	M-630
KD-104-12	KH-8-15M-3	KN-45-6	KS-7-13M-6	M-1110	M-18MM13	M3P07	M-638
KD-105-3	KH-8-15M-6	KN-45-9	KS-7-13M-9	M-1112	M-18MM15	M3P08	M-6MM11
KD-105-6	KH-8-15M-9	KN-7-12M-6	KSM-25-3	M-1114	M-18MM25	M3P10	M-6MM13
KD-205-6	KH-8-16M-12	KN-7-12M-9	KSM-25-B-6	M-1116	M-18MM35	M3P12	M-6MM21
KD-43-6	KH-8-16M-3	KN-7-13M-12	KSM-37-6	M-1118	M-18MM55	M3P14	M-6MME1
KD-44-6	KH-8-16M-4	KN-7-13M-6	KSM-37-B-6	M-11MM03	M-19MM15	M3P16	M-6MME3
KD-45-6	KH-8-16M-9	KN-7-13M-9	KT-10-19M-6	M-11MM11	M1E06	M3P18	M6N-0806-2
KD-6-10M-12	KH-8-17M-3	KN-7-14M-6	KT-104-6	M-11MM13	M1E07	M-44-90	M6N-0806-3
KD-6-10M-6	KH-8-17M-4	KN-7-14M-9	KT-105-12	M-11MM15	M1E08	M-450	M6N-0806-5
KD-6-10M-9	KH-8-17M-6	KN-8-15M-12	KT-105-6	M-11MM21	M1E10	M-460	M6N-0806-6
KD-7-11M-12	KH-8-17M-9	KN-8-15M-6	KT-105-9	M-11MM43	M1E11	M-470	M6N-0808-2
KD-7-11M-6	KH-8-18M-3	KN-8-15M-9	KT-202-12	M-11MME1	M1E12	M-480	M6N-0808-3
KD-7-12M-12	KH-8-18M-4	KN-8-16M-12	KT-202-6	M-11MME3	M1E14	M-480-6	M6N-0808-4
KD-7-12M-6	KH-8-18M-6	KN-8-16M-9	KT-202-9	M-1208	M1E16	M-488	M6N-0808-5
KD-7-12M-9	KH-8-18M-9	KN-8-17M-6	KT-203-12	M-1209	M1P06	M-490	M6N-0808-6
KD-7-13M-12	KHM-37-6	KN-8-17M-9	KT-203-6	M-1210	M1P07	M-490-10	M6N-0810-2
KD-7-13M-6	KHM-38-6	KN-8-18M-12	KT-203-9	M-1212	M1P08	M-490-12	M6N-0810-3
KD-7-13M-9	KHM-50-6	KN-8-18M-6	KT-205-12	M-1214	M1P09	M-490-2	M6N-0810-4
KD-7-14M-6	KHM-50-B-6	KN-8-18M-9	KT-205-6	M-12MM03	M1P10	M-490-2-OR	M6N-0810-5
KD-7-14M-9	KHW-C-105-12	KNM-37-6	KT-317-9	M-12MM11	M1P11	M-490-4	M6N-0810-6
KD-8-15M-12	KHW-C-105-6	KNM-38-6	KT-318-6	M-12MM13	M1P12	M-490-6	M6N-08-10M-3
KD-8-15M-6	KHW-C-205-12	KNM-50-6	KT-320-12	M-12MM15	M1P14	M-490-8	M6N-08-10M-4
KD-8-15M-9	KHW-C-205-6	KNM-50-B-6	KT-320-6	M-12MM21	M1P16	M-490-NR	M6N-08-10M-6
KDM-37-3	KHW-C-322-6	KNW-C-105-12	KT-320-9	M-12MM43	M-21MM15	M-490-OR	M6N-0811-2
KDM-37-6	KHW-C-409-6	KNW-C-105-6	KT-322-6	M-12MME1	M-3012	M-495	M6N-0811-3
KDM-37-B-3	KHW-C-43-6	KNW-C-205-12	KT-322-9	M-13MM03	M-3014	M-495-5	M6N-0812-2
KDM-38-6	KHW-C-44-6	KNW-C-205-6	KT-44-6	M-13MM11	M-3016	M-497	M6N-0812-3
KH-10-19M-12	KHW-C-45-6	KNW-C-322-12	KT-6-10M-12	M-13MM13	M-3018	M-498	M6N-0812-4
KH-10-19M-3	KHW-C-7-13m-6	KNW-C-322-6	KT-6-10M-6	M-13MM15	M-3109	M-4MME1	M6N-0812-6
KH-10-19M-6	KHW-C-7-13m-9	KNW-C-43-6	KT-6-10M-9	M-13MM21	M-3110	M-5.5MM11	M6N-08-12M-3
KH-10-19M-9	KHW-C-7-14m-6	KNW-C-44-6	KT-7-13M-6	M-13MM25	M-3112	M-5.5MME1	M6N-08-12M-4
KH-104-6	KHW-C-8-15m-6	KNW-C-45-6	KT-7-13M-9	M-13MM35	M-3114	M-5110	M6N-08-12M-6
KH-105-12	KHW-C-8-15m-9	KNW-C-7-13m-6	KT-7-14M-12	M-13MM43	M-3116	M-5112	M6N-0814-2
KH-105-3	KHW-C-8-16m-9	KNW-C-7-13m-9	KT-7-14M-6	M-13MM45	M-3118	M-5114	M6N-0814-3
KH-105-6	KHW-C-8-17m-6	KNW-C-7-14m-6	KT-7-15M-6	M-13MM55	M-3120	M-5116	M6N-0814-4
KH-202-6	KHW-C-8-17m-9	KNW-C-8-15m-12	KT-8-13M-12	M-13MME1	M-320X	M-5118	M6N-0814-6
KH-203-4	KHW-C-8-18m-6	KNW-C-8-15m-6	KT-8-15M-12	M-13MME3	M-3212	M-5120	M6N-0816-2
KH-203-6	KHW-C-8-18m-9	KNW-C-8-16m-9	KT-8-15M-6	M-13MME5	M-3214	M-5122	M6N-0816-3
KH-203-9	KN-104-6	KNW-C-8-17m-6	KT-8-15M-9	M-14MM11	M-3216	M-5124	M6N-0818-2
KH-205-12	KN-104-9	KNW-C-8-17m-9	KT-8-16M-12	M-14MM13	M-3218	M-5216	M6N-08-8M-3
KH-205-3	KN-105-12	KNW-C-8-18m-6	KT-8-16M-6	M-14MM15	M-322X	M-5218	M6N-08-8M-4
KH-205-4	KN-105-6	KNW-C-8-18m-9	KT-8-16M-9	M-14MM43	M-328X	M-5316	M6N-08-8M-6
KH-205-6	KN-105-9	KS-100-6	KT-8-17M-6	M-14MM45	M-32-TX-15	M-5416	M-7MM11
KH-318-4	KN-202-6	KS-102-6	KT-8-18M-12	M-1500-P	M-32-TX-20	M-5418	M-7MM13
KH-320-6	KN-202-8	KS-104-6	KT-8-18M-6	M-1505-P	M-3408	M-5420	M-7MM21
KH-321-6	KN-203-12	KS-105-6	KT-8-18M-9	M-15MM03	M-3410	M-5512	M-7MME1
KH-322-6	KN-203-6	KS-105-9	L-320X	M-15MM11	M-3411	M-5518	M-7MME3
KH-409-12	KN-203-9	KS-25-6	L-322X	M-15MM13	M-3412	M5E10	M-8MM13
KH-409-3	KN-205-12	KS-26-12	L-328X	M-15MM15	M-3414	M5E12	M-8MM21
KH-409-4	KN-205-6	KS-26-6	M-10MM03	M-15MM25	M-3416	M5E14	M-8MM43
KH-409-6	KN-206-9	KS-28-12	M-10MM11	M-15MM35	M-3418	M5E16	M-8MME1
KH-43-6	KN-318-3	KS-28-6	M-10MM13	M-15MM43	M-3424	M5E18	M-8MM21
KH-44-6	KN-318-4	KS-29-6	M-10MM15	M-15MM45	M-3426	M-5MM11	M-8MM43
KH-45-3	KN-320-12	KS-30-6	M-10MM21	M-15MME5	M-3514	M-5MME1	M-8MM13
KH-45-4	KN-322-12	KS-5-7M-6	M-10MM43	M-15-SC	M3E08	M5P10	M-8MM21
KH-45-6	KN-322-6	KS-5-7M-9	M-10MME1	M-15-SC-A	M3E10	M5P12	M-8MM43
KH-7-13M-3	KN-322-9	KS-6-10M-6	M-10MME3	M-16MM13	M3E12	M5P14	M-8MME1
KH-7-13M-4	KN-404-6	KS-6-10M-9	M-1105	M-16MM15	M3E14	M5P16	M-8MME3
KH-7-13M-6	KN-43-6	KS-6-8M-6	M-1106	M-17MM13	M3E16	M5P18	M-9MM11

Part Number Index

Part No.	Part No.	Part No.	Part No.	Part No.	Part No.	Part No.	Part No.
M-9MM13	MB-6MM21	MHM-10mm	P-320X	SA-16-8M	SA-510	SC-614	SF-14MM25
M-9MM21	MB-6MM23	MHM-1310	P-322X	SA-200	SA-510-19M	SC-620	SF-14MM35
M-9MME1	MB-7MM21	MHM-1912	P-328X	SA-201	SA-510-20M	SC-720	SF-14MM45
MB-10MM21	MB-7MM23	MHM-7mm	QR-108	SA-202	SA-510-21M	SC-724	SF-14MM55
MB-10MM23	MB-8MM21	MHM-8mm	QR-308	SA-202-D	SA-510-22M	SC-728	SF-15MM03
MB-10MM25	MB-8MM23	MR-7MME1	QR-314	SA-203	SA-510-24M	SC-820	SF-15MM11
MB-10MM33	MB-9MM21	MSH-335	QR-508	SA-203-D	SA-535	SC-828	SF-15MM13
MB-11MM21	MB-9mm23	MSH-336	QR-514	SA-205	SA-537	SD-1055-A	SF-15MM15
MB-11MM23	MB-HE-9518	MSH-400	QR-520	SA-205-D	SA-538	SD-1342-2	SF-15MM16
MB-1206	MDA-08	MSW-343	QR-614	SA-216	SA-57-13M	SD-1342-2-PZD	SF-15MM23
MB-1208	MDA-10	MSW-350	QR-620	SA-216-D	SA-57-14M	SD-4048	SF-15MM25
MB-1209	MDA-10MM	MSW-604	QR-714	SA-217	SA-58-15M	SD-4462-3	SF-15MM33
MB-1210	MDA-10MM-80M	MSW-90	QR-720	SA-217-D	SA-58-16M	SD-4693	SF-15MM35
MB-1211	MDA-12	MSW-90-B	QR-820	SA-218	SA-58-17M	SD-5187	SF-15MM36
MB-1212	MDA-14	MSW-984-B	QR-824	SA-218-D	SA-58-18M	SD-5197	SF-15MM43
MB-1214	MDA-6MM	MX-1108	QRA-08	SA-219	SA-601	SD-556	SF-15MM45
MB-1216	MDA-7MM	MX-1109	QRA-14	SA-219-D	SA-603	SD-556-A	SF-15MM55
MB-1218	MDA-8MM	MX-1110	QR-F08	SA-221	SA-604	SF-10MM03	SF-16MM13
MB-12MM21	MDAT-08	MX-1111	QRF-14	SA-221-D	SA-606	SF-10MM11	SF-16MM15
MB-12MM23	MDB-08	MX-1112	QRF-20	SA-25	SA-607	SF-10MM13	SF-16MM16
MB-12MM25	MDB-10	MZA-110	QR-M-490-2	SA-25-D	SA-609	SF-10MM15	SF-16MM25
MB-1308	MDB-12	MZA-310	QR-M-490-200M	SA-26	SA-610	SF-10MM21	SF-16MM35
MB-1311	MDB-14	MZA-314	QR-M-490-A	SA-26-D	SA-65	SF-10MM23	SF-16MM45
MB-1312	MDC-08	MZA-510	QR-M-490-A6	SA-28	SA-712	SF-10MM25	SF-16MM55
MB-1314	MDC-10	MZA-514	R-320X	SA-28-D	SA-716	SF-10MM33	SF-17MM03
MB-13MM21	MDC-12	MZN-312	R-321X	SA-29	SA-C-216	SF-10MM35	SF-17MM13
MB-13MM23	MET-1301C	MZN-314	R-322X	SA-29-D	SA-C-217	SF-10MM43	SF-17MM15
MB-13MM25	MET-1302C	MZN-514	R-328X	SA-30	SA-C-218	SF-10MM45	SF-17MM16
MB-13MM33	MET-1401C	NP-32-TX-25	R-32-TX-27	SA-302	SA-C-219	SF-10MM55	SF-17MM23
MB-14MM21	MET-1402C	OL-322X	RM-490	SA-305	SA-C-221	SF-1112	SF-17MM25
MB-14MM23	MET-1600C	OOL-322X	RM-490-4	SA-306	SA-C-321	SF-1116	SF-17MM35
MB-14MM25	MET-1800C	OOOL-322X	RM-490-6	SA-30-D	SA-C-322	SF-11MM13	SF-17MM43
MB-15MM21	MF-25	OS-10MM03	RP-314	SA-316	SA-C-36-10M	SF-11MM15	SF-17MM45
MB-15MM23	MF-25-B	OS-10MM11	RP-514	SA-317	SA-C-37-12M	SF-11MM23	SF-17MM55
MB-15MM25	MF-27	OS-10MM23	RP-520	SA-318	SA-C-37-13M	SF-11MM25	SF-18MM13
MB-15MM33	MF-27-B	OS-3310-D	RP-520	SA-318-D	SA-C-37-14M	SF-11MM43	SF-18MM15
MB-16MM23	MF-37	OS-3410	RP-520	SA-320	SA-C-38-15M	SF-11MM45	SF-18MM16
MB-16MM25	MF-37-B	OS-5424	RP-614	SA-321	SA-C-38-17M	SF-11MM55	SF-18MM23
MB-16MM21	MF-38-B	OS-5516	RP-720	SA-321-D	SA-C-38-18M	SF-12MM03	SF-18MM25
MB-17MM23	MF-39	OS-5518	RP724	SA-322	SA-C-407	SF-12MM13	SF-18MM35
MB-18MM23	MF-39B	OS-8MM13	RP-728	SA-322-D	SA-C-409	SF-12MM15	SF-18MM36
MB-18MM25	MF-50	OSM-3410	RP-820	SA-36-10M	SA-C-410	SF-12MM21	SF-18MM43
MB-18MM35	MF-50B	OSM-3414	RP-828	SA-37-12M	SA-C-411	SF-12MM23	SF-18MM45
MB-3210	MF-51	OSMB-10MM21	RP-848	SA-37-13M	SA-C-508	SF-12MM25	SF-18MM55
MB-3212	MF-55	OSMB-10MM23	S-320X	SA-37-14M	SA-C-510	SF-12MM35	SF-19MM13
MB-3214	MF-55B	OSMB-8MM23	S-321X	SA-38-15M	SA-C-510-21M	SF-12MM43	SF-19MM15
MB-3216	MF-62	OSSF-10MM23	S-328X	SA-38-17M	SA-C-510-22M	SF-12MM45	SF-19MM16
MB-3218	MF-62B	OSSF-10MM43	S-32-TX-30	SA-38-18M	SA-C-57-13M	SF-13MM03	SF-19MM23
MB-3220	MF-70	OSSF-3512	SA-120	SA-402	SA-C-57-14M	SF-13MM11	SF-19MM25
MB-3314	MF-70B	OSSF-3514	SA-120-D	SA-402-D	SA-C-58-15M	SF-13MM13	SF-19MM35
MB-3318	MF-75B	OSSF-8MM23	SA-122	SA-404	SA-C-58-16M	SF-13MM15	SF-19MM36
MB-3512	MF-76	P-1408	SA-122-D	SA-404-D	SA-C-58-17M	SF-13MM21	SF-19MM43
MB-3514	MF-76B	P-1409	SA-123	SA-406	SA-C-58-18M	SF-13MM23	SF-19MM45
MB-3516	MF-77B	P-1410	SA-123-D	SA-407	SA-C-58-18M	SF-13MM25	SF-19MM55
MB-5212	MF-82	P-1412	SA-124	SA-409	SA-C-58-18M	SF-13MM33	SF-20MM15
MB-5214	MF-82B	P-1414	SA-124-D	SA-409-D	SA-C-58-18M	SF-13MM35	SF-21MM15
MB-5216	MFL-1000	P-1416	SA-125	SA-410	SA-C-58-18M	SF-13MM43	SF-21MM16
MB-5220	MFL-250	P-2010	SA-125-D	SA-411	SA-C-58-18M	SF-13MM45	SF-21MM25
MB-5MM21	MHA-510	P-2012	SA-15-6M	SA-501	SA-C-58-18M	SF-13MM55	SF-21MM35
MHC-3816	MHGNC-14624	P-2014	SA-15-7M	SA-505	SA-C-58-18M	SC-520	SF-21MM36
M-9MM11		P-2016	SA-16-10M	SA-508	SC-529	SF-14MM15	SF-21MM45

Part Number Index

Part No.	Part No.	Part No.	Part No.	Part No.	Part No.	Part No.	Part No.
SF-21MM55..... 56	SF-5230..... 51	SH-629..... 74	SZ-14-22MM..... 19	SZ-5-7-5MM..... 19	TW-6..... 22	TX-5412..... 58	WJ-284-9/64..... 75
SF-22MM15..... 56	SF-5232..... 51	SH-629-5..... 74	SZ-14-24MM..... 19	SZ-5-7-6MM..... 19	TW-7..... 22	TX-5414..... 58	X-1108..... 35
SF-22MM16..... 61	SF-5318..... 51	SH-629-6..... 74	SZ-14-27MM..... 19	SZ-5-7-8MM..... 19,57	TWA-6..... 22	TX-5416..... 58	X-1110..... 35
SF-22MM25..... 56	SF-5320..... 51	SH-629-P..... 74	SZ-14-A..... 18,43,53	SZ-7..... 18	TWA-7..... 22	TX-5418..... 58	Y-321X..... 9
SF-22MM35..... 56	SF-5324..... 51	SJ-241..... 77	SZ-14-A-3..... 18	SZ-7-10-10MM..... 19	TWA-8..... 22	TX-5420..... 58	YK-250..... 76
SF-22MM36..... 61	SF-5328..... 51	SJ-349..... 77	SZ-14-A-4..... 18	SZ-7-10-12MM..... 19	TWB-6..... 22	U-321X..... 9	YK-252..... 76
SF-22MM55..... 56	SF-5330..... 51	SJ-350..... 77	SZ-15..... 18,43	SZ-7-10-14MM..... 19	TWB-7..... 22	UG-10MM13..... 70	YK-370..... 76
SF-23MM15..... 56	SF-5412..... 51	SJ-351..... 77	SZ-15-A..... 18,43,53	SZ-7-10-17MM..... 19	TWB-8..... 22	UG-10MM21..... 70	YK-372..... 76
SF-24MM15..... 56	SF-5414..... 51	SJ-352..... 77	SZ-16..... 18,43	SZ-7-10MM..... 19,46,57	TWD-0..... 22	UG-10MM23..... 70	YK-500..... 76
SF-24MM16..... 61	SF-5416..... 50	SJ-360..... 77	SZ-16-A..... 18,43,53	SZ-7-12MM..... 19,57	TWD-1..... 22	UG-13MM23..... 70	YK-501..... 76
SF-24MM25..... 56	SF-5418..... 50	SJ-361..... 77	SZ-16-A-3..... 18	SZ-7-14MM..... 19,57	TWD-2..... 22	UG-13MM25..... 70	YK-502..... 76
SF-24MM35..... 56	SF-5420..... 51	SJ-362..... 77	SZ-16-A-4..... 18	SZ-7-4MM..... 19,46	TWD-3..... 22	UG-15MM25..... 70	ZA-110..... 75
SF-24MM36..... 61	SF-5422..... 50	SJ-364..... 77	SZ-17..... 18	SZ-7-5MM..... 19,46	TWD-4..... 22	UG-18MM25..... 70	ZA-310..... 75
SF-3010..... 41	SF-5424..... 50	SJ-375..... 77	SZ-17-A..... 18,53	SZ-7-6MM..... 19,46	TWD-4-ACR..... 22	UG-825..... 70	ZA-314..... 75
SF-3012..... 41	SF-5426..... 50	SJ-379..... 77	SZ-18..... 18	SZ-7-8MM..... 19,46,57	TWD-5..... 22	UG-835..... 70	ZA-510..... 75
SF-3014..... 41	SF-5514..... 51	SJ-380..... 77	SZ-18-A..... 18,53	SZ-7-A..... 18	TWD-5-ACR..... 22	UG-838..... 70	ZA-512..... 75
SF-3016..... 41	SF-5516..... 51	SJ-55..... 77	SZ-19..... 18	SZ-80..... 19	TWD-6..... 22	UG-855..... 70	ZA-514..... 75
SF-3018..... 41	SF-5518..... 51	SJ-66..... 77	SZ-19-A..... 18,53	SZ-8-14-17MM..... 19	TWD-7..... 22	UG-EX-250-4..... 70	ZE-112..... 75
SF-3110..... 41	SF-5520..... 51	SJ-67..... 77	SZ-20..... 18	SZ-8-14-19MM..... 19	TWE-4..... 22	UG-EX-250-6..... 70	ZE-314..... 75
SF-3112..... 41	SF-5524..... 51	SJ-68..... 77	SZ-21..... 18	SZ-8-14-22MM..... 19	TWE-5..... 22	UG-EX-370-2..... 70	ZE-514..... 75
SF-3114..... 41	SF-5526..... 51	SJ-935-1/2..... 74	SZ-22..... 18,53	SZ-8-14-24MM..... 19	TX-1104..... 39	UG-EX-370-4..... 70	ZN-112..... 75
SF-3116..... 41	SF-5528..... 51	SJ-935-1/4..... 74	SZ-23..... 18,53	SZ-8-14-27MM..... 19	TX-1105..... 39	UG-EX-370-6..... 70	ZN-114..... 75
SF-3118..... 41	SF-5532..... 51	SJ-935-10MMXM6..... 74	SZ-24..... 18,53	SZ-85..... 19	TX-1106..... 39	UG-EX-376-12..... 70	ZN-312..... 75
SF-3120..... 41	SF-6118..... 60	SJ-935-12MMXM8..... 74	SZ-25..... 18,53	SZ-85-A..... 19	TX-1108..... 39	UG-EX-376-3..... 70	ZN-314..... 75
SF-3212..... 42	SF-6120..... 60	SJ-935-14MMXM10..... 74	SZ-26..... 18,53	SZ-86..... 19	TX-1110..... 39	UG-EX-376-6..... 70	ZN-512..... 75
SF-3214..... 42	SF-6124..... 60	SJ-935-17MMXM12..... 74	SZ-27..... 18	SZ-87..... 19	TX-1112..... 39	UG-EX-508-12..... 70	ZN-514..... 75
SF-3216..... 42	SF-6128..... 60	SJ-935-17MMXM8..... 74	SZ-30..... 19	SZ-88..... 19	TX-1404..... 39	UG-EX-508-4..... 70	
SF-3218..... 42	SF-6320..... 60	SJ-935-3/8 FS..... 74	SZ-30-A..... 19	SZ-89..... 19	TX-1405..... 39	UG-EX-508-8..... 70	
SF-3224..... 42	SF-6324..... 60	SJ-935-5/16..... 74	SZ-31..... 19	SZ-8L-TX-70..... 12	TX-1406..... 39	UG-M-10MM13..... 70	
SF-3314..... 42	SF-6326..... 60	SJ-935-7/16..... 74	SZ-31-A..... 18,19,53	SZ-9..... 18	TX-1407..... 39	UG-M-10MM21..... 70	
SF-3316..... 42	SF-6328..... 60	SW-282..... 49	SZ-32..... 19	SZ-91..... 18	TX-1408..... 39	UG-M-10MM23..... 70	
SF-3318..... 42	SF-6330..... 60	SW-282-D..... 49	SZ-32-A..... 18,19,53	SZ-9-A..... 18	TX-1410..... 39	UG-M-13MM23..... 70	
SF-3320..... 42	SF-6424..... 60	SW-343..... 40	SZ-33..... 19	SZ-TX-100..... 12	TX-1411..... 39	UG-M-490..... 70	
SF-3324..... 42	SF-6524..... 60	SW-350..... 78	SZ-33-A..... 19	SZ-TX-100-A..... 10	TX-1412..... 39	UG-M-490-4..... 70	
SF-3412..... 41	SF-8MM11..... 37	SW-493..... 45	SZ-34..... 19	SZ-TX-55-A..... 10	TX-1E05..... 39	UG-M-490-6..... 70	
SF-3414..... 41	SF-8MM13..... 45	SW-604..... 40	SZ-34-A..... 19	SZ-TX-60-A..... 10	TX-1E06..... 39	UG-M-825..... 70	
SF-3416..... 41	SF-8MM23..... 45	SW-605..... 40	SZ-35..... 19	SZ-TX-70-A..... 10	TX-1E08..... 39	UG-M-835..... 70	
SF-3418..... 41	SF-HC-3816..... 41	SW-605-D..... 40	SZ-35-A..... 19	SZ-TX-70-A-3..... 10	TX-3106..... 47	UG-M-838..... 70	
SF-3432..... 41	SF-HE-9518..... 51	SZ-10..... 18,43	SZ-36..... 19	SZ-TX-80-A..... 10	TX-3107..... 47	UG-M-855..... 70	
SF-3512..... 42	SF-SH-335..... 50	SZ-101..... 19	SZ-36-A..... 19	SZ-TX-90-A..... 10	TX-3108..... 47	UG-M-858..... 70	
SF-3514..... 42	SF-SH-336..... 50	SZ-10-10MM..... 19	SZ-37..... 19	T-320X..... 9	TX-3110..... 47	UG-MB-10MM21..... 70	
SF-3516..... 42	SF-SW-282..... 50	SZ-10-12MM..... 19	SZ-37-7-10MM..... 19,46	T-321X..... 9	TX-3112..... 47	UG-MB-10MM23..... 70	
SF-3518..... 42	SH-335..... 49	SZ-10-14MM..... 19,57	SZ-3-7-4MM..... 19,46	TH-250..... 30	TX-3114..... 47	UG-MB-13MM23..... 70	
SF-5112..... 50	SH-336..... 49	SZ-10-17MM..... 19,57	SZ-3-7-5MM..... 19,46	TH-257..... 76	TX-3116..... 47	UG-SF-13MM25..... 70	
SF-5116..... 50	SH-336-D..... 49	SZ-10-19MM..... 19	SZ-3-7-6MM..... 19,46	TH-370..... 30	TX-3406..... 47	UG-SF-15MM25..... 70	
SF-5118..... 50	SH-338..... 49	SZ-101-A..... 19	SZ-3-7-8MM..... 19,46	TH-372..... 30	TX-3407..... 47	UG-SF-18MM25..... 70	
SF-5120..... 50	SH-338-D..... 49	SZ-10-A..... 18,43	SZ-37-A..... 19	TH-376..... 30	TX-3408..... 47	W-321X..... 9	
SF-5122..... 50	SH-339..... 49	SZ-11..... 18,43	SZ-38..... 19	TH-377..... 76	TX-3410..... 47	WJ-265-1/2..... 75	
SF-5124..... 50	SH-402..... 74	SZ-11-A..... 18,43	SZ-38-A..... 19	TH-378..... 76	TX-3412..... 47	WJ-265-1/4..... 75	
SF-5126..... 50	SH-404..... 74	SZ-11-A-3..... 18	SZ-39-A..... 19	TH-501..... 76	TX-3414..... 47	WJ-265-13/64..... 75	
SF-5128..... 50	SH-412..... 74	SZ-12..... 18,43	SZ-41..... 18	TH-502..... 76	TX-3508..... 47	WJ-265-17/32..... 75	
SF-5130..... 50	SH-414..... 74	SZ-12-A..... 18,43	SZ-42..... 18,53	TM-20..... 76	TX-3E08..... 47	WJ-265-3/16..... 75	
SF-5132..... 50	SH-57..... 74	SZ-12-A-2..... 18	SZ-43..... 18,53	TM-24..... 76	TX-3E10..... 47	WJ-265-3/8..... 75	
SF-5134..... 50	SH-57-3..... 74	SZ-12-A-3..... 18	SZ-44..... 18,53	TN-20..... 76	TX-5112..... 58	WJ-265-7/16..... 75	
SF-5212..... 51	SH-57-4..... 74	SZ-12-A-6..... 18	SZ-5-10-14MM..... 19,57	TN-24..... 76	TX-5114..... 58	WJ-284-1/4..... 75	
SF-5216..... 51	SH-57-6..... 74	SZ-13..... 18,43	SZ-5-10-17MM..... 19,57	TW-0..... 22	TX-5116..... 58	WJ-284-1/8..... 75	
SF-5218..... 51	SH-57-8..... 74	SZ-13-A..... 18,43	SZ-5-10-19MM..... 19	TW-1..... 22	TX-5118..... 58	WJ-284-3/16..... 75	
SF-5222..... 51	SH-59..... 74	SZ-13-A-3..... 18	SZ-5-7-10MM..... 19,57	TW-2..... 22	TX-5120..... 58	WJ-284-3/8..... 75	
SF-5224..... 51	SH-59-3..... 74	SZ-14..... 18,43	SZ-5-7-12MM..... 19,57	TW-3..... 22	TX-5124..... 58	WJ-284-5/16..... 75	
SF-5226..... 51	SH-59-4..... 74	SZ-14-17MM..... 19	SZ-5-7-14MM..... 19,57	TW-4..... 22	TX-5408..... 58	WJ-284-5/32..... 75	
SF-5228..... 51	SH-59-6..... 74	SZ-14-19MM..... 19	SZ-5-7-4MM..... 19	TW-5..... 22	TX-5410..... 58	WJ-284-7/64..... 75	

Conversion Tables

Millimeter – Decimal – Fraction

mm	Dec.	in.	mm	Dec.	in.	mm	Dec.	in.	mm	Dec.	in.	mm	Dec.	in.
0.100	.0039		5.159	.2031	13/64	10.200	.4016		15.300	.6024		20.300	.7992	
0.200	.0079		5.200	.2047		10.300	.4055		15.400	.6063		20.400	.8031	
0.300	.0118		5.300	.2087		10.319	.4063	13/32	15.478	.6094	39/64	20.500	.8071	
0.397	.0156	1/64	5.400	.2126		10.400	.4094		15.500	.6102		20.600	.8110	
0.400	.0157		5.500	.2165		10.500	.4134		15.600	.6142		20.638	.8125	13/16
0.500	.0197		5.556	.2188	7/32	10.600	.4173		15.700	.6181		20.700	.8150	
0.600	.0236		5.600	.2205		10.700	.4219		15.800	.6220		20.800	.8189	
0.700	.0276		5.700	.2244		10.716	.4219	27/64	15.875	.6250	5/8	20.900	.8228	
0.794	.0313	1/32	5.800	.2283		10.800	.4252		15.900	.6250		21.000	.8268	
0.800	.0315		5.900	.2323		10.900	.4291		16.000	.6299		21.034	.8182	53/64
0.900	.0354		5.953	.2344	15/64	11.000	.4331		16.100	.6339		21.100	.8307	
1.000	.0394		6.000	.2362		11.100	.4370		16.200	.6378		21.200	.8307	
1.100	.0433		6.100	.2402		11.113	.4375	7/16	16.272	.6406	41/64	21.200	.8346	
1.191	.0469	3/64	6.200	.2441		11.200	.4409		16.300	.6417		21.300	.8386	
1.200	.0472		6.300	.2480		11.300	.4449		16.400	.6457		21.400	.8425	
1.300	.0512		6.350	.2500	1/4	11.400	.4488		16.500	.6496		21.431	.8438	27/32
1.400	.0551		6.400	.2520		11.500	.4528		16.600	.6535		21.500	.8465	
1.500	.0591		6.500	.2559		11.509	.4531	29/64	16.669	.6563	21/32	21.600	.8504	
1.588	.0625	1/16	6.600	.2598		11.600	.4567		16.700	.6575		21.700	.8543	
1.600	.0630		6.700	.2638		11.700	.4606		16.800	.6614		21.800	.8583	
1.700	.0669		6.747	.2656	17/64	11.800	.4646		16.900	.6654		21.828	.8594	55/94
1.800	.0709		6.800	.2677		11.900	.4685		17.000	.6693		21.900	.8622	
1.900	.0748		6.900	.2717		11.906	.4688	15/32	17.066	.6719	43/64	22.000	.8661	
1.984	.0781	5/64	7.000	.2756		12.000	.4724		17.100	.6732		22.100	.8701	
2.000	.0878		7.100	.2795		12.100	.4764		17.200	.6772		22.200	.8740	
2.100	.0827		7.144	.2813	9/32	12.200	.4803		17.300	.6811		22.225	.8750	7/8
2.200	.0866		7.200	.2835		12.300	.4843		17.400	.6850		22.300	.8780	
2.300	.0906		7.300	.2874		12.303	.4844	31/64	17.463	.6875	11/16	22.400	.8819	
2.381	.0938	3/32	7.400	.2913		12.400	.4882		17.500	.6890		22.500	.8858	
2.400	.0945		7.500	.2953		12.500	.4921		17.600	.6929		22.600	.8898	
2.500	.0984		7.541	.2969	19/64	12.600	.4961		17.700	.6968		22.622	.8906	57/64
2.600	.1024		7.600	.2992		12.700	.4999		17.800	.7008		22.700		

POWER TOOLS SALES & SERVICE CENTERS

Please note that all locations may not service all products.
Contact the nearest Apex Tool Group Sales & Service Center for the appropriate facility to handle your service requirements.

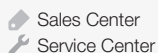

NORTH AMERICA | SOUTH AMERICA

Detroit, Michigan 🏠

Apex Tool Group
2630 Superior Court
Auburn Hills, MI 48236
Phone: +1 (248) 393-5640
Fax: +1 (248) 391-6295

Lexington, South Carolina 🏠

Apex Tool Group
670 Industrial Drive
Lexington, SC 29072
Phone: +1 (800) 845-5629
Phone: +1 (919) 387-0099
Fax: +1 (803) 358-7681

Louisville, Kentucky 🛠️

Apex Tool Group
1000 Glengarry Drive
Suite 150
Fairdale, KY 40118
apexpowertools.com/service

Canada 🏠🛠️

Apex Tool Canada, Ltd.
7631 Bath Road
Mississauga, Ontario L4T 3T1
Canada
Phone: (866) 691-6212
Fax: (905) 673-4400

Mexico 🏠🛠️

Apex Tool Group
Manufacturing México
S. de R.L. de C.V.
Vialidad El Pueblito #103
Parque Industrial Querétaro
Querétaro, QRO 76220
Mexico
Phone: +52 (442) 211 3800
Fax: +52 (800) 685 5560

Brazil 🏠🛠️

Apex Tool Group
Ind. Com. Ferram, Ltda.
Av. Liberdade, 4055
Zona Industrial Iporanga
Sorocaba, São Paulo
CEP# 18087-170
Brazil
Phone: +55 15 3238 3820
Fax: +55 15 3238 3938

EUROPE | MIDDLE EAST | AFRICA

England 🏠🛠️

Apex Tool Group
GmbH & Co. OHG
C/O Spline Gauges
Piccadilly, Tamworth
Staffordshire B78 2ER
United Kingdom
Phone: +44 1827 8727 71
Fax: +44 1827 8741 28

France 🏠🛠️

Apex Tool Group S.A.S.
25 rue Maurice Chevalier
B.P. 28
77831 Ozoir-La-Ferrière
Cedex, France
Phone: +33 1 64 43 22 00
Fax: +33 1 64 43 17 17

Germany 🏠🛠️

Apex Tool Group
GmbH & Co. OHG
Industriestraße 1
73463 Westhausen
Germany
Phone: +49 (0) 73 63 81 0
Fax: +49 (0) 73 63 81 222

Hungary 🏠🛠️

Apex Tool Group
Hungária Kft.
Platánfa u.2
9027 Győr
Hungary
Phone: +36 96 66 1383
Fax: +36 96 66 1135

ASIA PACIFIC

Australia 🏠

Apex Tool Group
519 Nurigong Street, Albury
NSW 2640
Australia
Phone: +61 2 6058 0300

China 🏠🛠️

Apex Power Tool Trading
(Shanghai) Co., Ltd
Building A8, No. 38
Dongsheng Road
Pudong, Shanghai
China 201201
Phone: +86 21 60880320
Fax: +86 21 60880298

India 🏠🛠️

Apex Power Tools India
Private Limited
Gala No. 1, Plot No. 5
S. No. 234, 235 & 245
Indialand Global
Industrial Park
Taluka-Mulsi, Phase I
Hinjawadi, Pune 411057
Maharashtra, India
Phone: +91 020 66761111

Japan 🏠🛠️

Apex Tool Group Japan
Korin-Kaikan 5F,
3-6-23 Shibakoen, Minato-Ku,
Tokyo 105-0011, JAPAN
Phone: +81-3-6450-1840
Fax: +81-3-6450-1841

Korea 🏠

Apex Tool Group Korea
#1503, Hibrand Living Bldg.,
215 Yangjae-dong,
Seocho-gu, Seoul 137-924,
Korea
Phone: +82-2-2155-0250
Fax: +82-2-2155-0252



Apex Tool Group, LLC

Phone: +1 (800) 845-5629
Fax: +1 (919) 387-2614
www.apexpowertools.com
apexfastenertools@apexpowertools.com