

## Optocoupler, Phototransistor Output, AC Input (Dual, Quad Channel)

Dual Channel

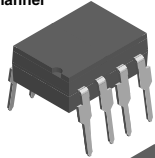

Quad Channel

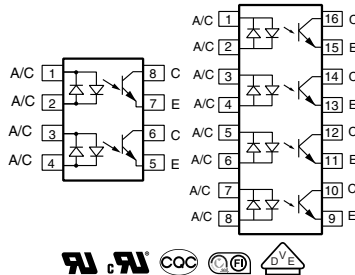
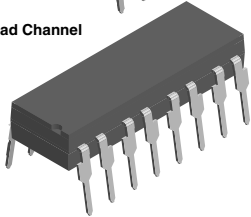

### FEATURES

- Identical channel to channel footprint
- ILD620 crosses to TLP620-2
- ILQ620 crosses to TLP620-4
- High collector emitter voltage,  $BV_{CEO} = 70\text{ V}$
- Dual and quad packages feature:
  - Reduced board space
  - Lower pin and parts count
  - Better channel to channel CTR match
  - Improved common mode rejection
- Isolation test voltage  $5300\text{ V}_{RMS}$
- Material categorization: For definitions of compliance please see [www.vishay.com/doc?99912](http://www.vishay.com/doc?99912)



**RoHS**  
COMPLIANT

### DESCRIPTION

The ILD620, ILQ620, ILD620GB, and ILQ620GB are multi-channel input phototransistor optocouplers that use inverse parallel GaAs IRLED emitter and high gain NPN silicon phototransistors per channel. These devices are constructed using over/under leadframe optical coupling and double molded insulation resulting in a withstand test voltage of  $5300\text{ V}_{RMS}$ .

The LED parameters and the linear CTR characteristics make these devices well suited for AC voltage detection. The ILD620GB and ILQ620GB with its low  $I_F$  guaranteed  $CTR_{CEsat}$  minimizes power dissipation of the  $A_C$  voltage detection network that is placed in series with the LEDs. Eliminating the phototransistor base connection provides added electrical noise immunity from the transients found in many industrial control environments.

### AGENCY APPROVALS

- UL1577, file no. E52744 system code H, double protection
- cUL tested to CSA 22.2 bulletin 5A
- DIN EN 60747-5-5 (VDE 0884)
- FIMKO
- CQC GB4943.1-2011 and GB8898:2011 (suitable for installation altitude below 2000 m)

### ORDERING INFORMATION



PART NUMBER

PACKAGE OPTION

TAPE AND REEL

x = D (Dual) or Q (Quad)

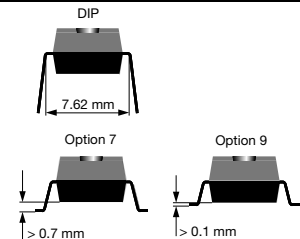

| AGENCY CERTIFIED/PACKAGE   | DUAL CHANNEL                |                               | QUAD CHANNEL                |                               |
|----------------------------|-----------------------------|-------------------------------|-----------------------------|-------------------------------|
|                            | CTR (%)                     |                               |                             |                               |
| <b>UL, cUL, FIMKO</b>      | <b>50 to 600</b>            | <b>100 to 600</b>             | <b>50 to 600</b>            | <b>100 to 600</b>             |
| DIP-8                      | ILD620                      | ILD620GB                      | -                           | -                             |
| SMD-8, option 7            | ILD620-X007T <sup>(1)</sup> | -                             | -                           | -                             |
| SMD-8, option 9            | ILD620-X009T <sup>(1)</sup> | ILD620GB-X009T <sup>(1)</sup> | -                           | -                             |
| DIP-16                     | -                           | -                             | ILQ620                      | ILQ620GB                      |
| SMD-16, option 7           | -                           | -                             | ILQ620-X007                 | -                             |
| SMD-16, option 9           | -                           | -                             | ILQ620-X009T <sup>(1)</sup> | ILQ620GB-X009T <sup>(1)</sup> |
| <b>VDE, UL, cUL, FIMKO</b> | <b>50 to 600</b>            | <b>100 to 600</b>             | <b>50 to 600</b>            | <b>100 to 600</b>             |
| DIP-16                     | -                           | -                             | ILQ620-X001                 | -                             |
| SMD-16, option 9           | -                           | -                             | ILQ620-X019T <sup>(1)</sup> | -                             |

#### Notes

- Additional options may be possible, please contact sales office.
- (1) Also available in tubes, do not put T on the end.



| ABSOLUTE MAXIMUM RATINGS (T <sub>amb</sub> = 25 °C, unless otherwise specified) |  |          |                   |                    |                  |
|---|--|----------|-------------------|--------------------|------------------|
| PARAMETER   | TEST CONDITION                                     | PART     | SYMBOL            | VALUE              | UNIT             |
| <b>INPUT</b>  |  |          |                   |                    |                  |
| Forward current   |  |          | I <sub>F</sub>    | ± 60               | mA               |
| Surge current   |  |          | I <sub>FSM</sub>  | ± 1.5              | A                |
| Power dissipation   |  |          | P <sub>diss</sub> | 100                | mW               |
| Derate linearly from 25 °C  |  |          |                   | 1.3                | mW/°C            |
| <b>OUTPUT</b>   |  |          |                   |                    |                  |
| Collector emitter breakdown voltage   |  |          | BV <sub>CEO</sub> | 70                 | V                |
| Collector current   |  |          | I <sub>C</sub>    | 50                 | mA               |
|   | t < 1 s  |          | I <sub>C</sub>    | 100                | mA               |
| Power dissipation   |  |          | P <sub>diss</sub> | 150                | mW               |
| Derate from 25 °C   |  |          |                   | 2                  | mW/°C            |
| <b>COUPLER</b>  |  |          |                   |                    |                  |
| Isolation test voltage  | t = 1 s  |          | V <sub>ISO</sub>  | 5300               | V <sub>RMS</sub> |
| Isolation voltage   |  |          | V <sub>IORM</sub> | 890                | V <sub>P</sub>   |
| Total power dissipation   |  |          | P <sub>tot</sub>  | 250                | mW               |
| Package dissipation   |  | ILD620   |                   | 400                | mW               |
|   |  | ILD620GB |                   | 400                | mW               |
| Derate from 25 °C   |  |          |                   | 5.33               | mW/°C            |
| Package dissipation   |  | ILQ620   |                   | 500                | mW               |
|   |  | ILQ620GB |                   | 500                | mW               |
| Derate from 25 °C   |  |          |                   | 6.67               | mW/°C            |
| Creepage distance   |  |          |                   | ≥ 7                | mm               |
| Clearance distance  |  |          |                   | ≥ 7                | mm               |
| Isolation resistance  | V <sub>IO</sub> = 500 V, T <sub>amb</sub> = 25 °C  |          | R <sub>IO</sub>   | ≥ 10 <sup>12</sup> | Ω                |
|   | V <sub>IO</sub> = 500 V, T <sub>amb</sub> = 100 °C |          | R <sub>IO</sub>   | ≥ 10 <sup>11</sup> | Ω                |
| Storage temperature   |  |          | T <sub>stg</sub>  | - 55 to + 150      | °C               |
| Operating temperature   |  |          | T <sub>amb</sub>  | - 55 to + 100      | °C               |
| Junction temperature  |  |          | T <sub>j</sub>    | 100                | °C               |
| Soldering temperature <sup>(1)</sup>  | 2 mm from case bottom                              |          | T <sub>sld</sub>  | 260                | °C               |

**Notes**

- Stresses in excess of the absolute maximum ratings can cause permanent damage to the device. Functional operation of the device is not implied at these or any other conditions in excess of those given in the operational sections of this document. Exposure to absolute maximum ratings for extended periods of the time can adversely affect reliability.
- <sup>(1)</sup> Refer to reflow profile for soldering conditions for surface mounted devices (SMD). Refer to wave profile for soldering conditions for through hole devices (DIP).

| ELECTRICAL CHARACTERISTICS (T <sub>amb</sub> = 25 °C, unless otherwise specified) |  |      |                   |      |      |      |      |
|---|--|------|-------------------|------|------|------|------|
| PARAMETER   | TEST CONDITION                                 | PART | SYMBOL            | MIN. | TYP. | MAX. | UNIT |
| <b>INPUT</b>  |  |      |                   |      |      |      |      |
| Forward voltage   | I <sub>F</sub> = ± 10 mA                       |      | V <sub>F</sub>    | 1    | 1.15 | 1.3  | V    |
| Forward current   | V <sub>R</sub> = ± 0.7 V                       |      | I <sub>F</sub>    |      | 2.5  | 20   | μA   |
| Capacitance   | V <sub>F</sub> = 0 V, f = 1 MHz                |      | C <sub>O</sub>    |      | 25   |      | pF   |
| Thermal resistance, junction to lead  |  |      | R <sub>thJL</sub> |      | 750  |      | K/W  |
| <b>OUTPUT</b>   |  |      |                   |      |      |      |      |
| Collector emitter capacitance   | V <sub>CE</sub> = 5 V, f = 1 MHz               |      | C <sub>CE</sub>   |      | 6.8  |      | pF   |
| Collector emitter leakage current   | V <sub>CE</sub> = 24 V                         |      | I <sub>CEO</sub>  |      | 10   | 100  | nA   |
|   | T <sub>A</sub> = 85 °C, V <sub>CE</sub> = 24 V |      | I <sub>CEO</sub>  |      | 2    | 50   | μA   |
| Thermal resistance, junction to lead  |  |      | R <sub>thJL</sub> |      | 500  |      | K/W  |



| ELECTRICAL CHARACTERISTICS ( $T_{amb} = 25\text{ }^{\circ}\text{C}$ , unless otherwise specified) |  |          |             |      |      |      |               |
|---|--|----------|-------------|------|------|------|---------------|
| PARAMETER   | TEST CONDITION                                     | PART     | SYMBOL      | MIN. | TYP. | MAX. | UNIT          |
| <b>COUPLER</b>  |  |          |             |      |      |      |               |
| Off-state collector current   | $V_F = \pm 0.7\text{ V}$ , $V_{CE} = 24\text{ V}$  |          | $I_{CEoff}$ |      | 1    | 10   | $\mu\text{A}$ |
| Collector emitter saturation voltage  | $I_F = \pm 8\text{ mA}$ , $I_{CE} = 2.4\text{ mA}$ | ILD620   | $V_{CEsat}$ |      |      | 0.4  | V             |
|   |  | ILQ620   | $V_{CEsat}$ |      |      | 0.4  | V             |
|   | $I_F = \pm 1\text{ mA}$ , $I_{CE} = 0.2\text{ mA}$ | ILD620GB | $V_{CEsat}$ |      |      | 0.4  | V             |
|   |  | ILQ620GB | $V_{CEsat}$ |      |      | 0.4  | V             |

**Note**

- Minimum and maximum values are testing requirements. Typical values are characteristics of the device and are the result of engineering evaluation. Typical values are for information only and are not part of the testing requirements.

| CURRENT TRANSFER RATIO ( $T_{amb} = 25\text{ }^{\circ}\text{C}$ , unless otherwise specified) |   |          |                 |        |      |        |      |
|---|---|----------|-----------------|--------|------|--------|------|
| PARAMETER   | TEST CONDITION  | PART     | SYMBOL          | MIN.   | TYP. | MAX.   | UNIT |
| Channel/channel CTR match   | $I_F = \pm 5\text{ mA}$ , $V_{CE} = 5\text{ V}$           |          | CTR/CTRY        | 1 to 1 |      | 3 to 1 |      |
| CTR symmetry  | $I_{CE} (I_F = -5\text{ mA})/I_{CE} (I_F = +5\text{ mA})$ |          | $I_{CE(RATIO)}$ | 0.5    |      | 2      |      |
| Current transfer ratio (collector emitter saturated)  | $I_F = \pm 1\text{ mA}$ , $V_{CE} = 0.4\text{ V}$         | ILD620   | $CTR_{CEsat}$   |        | 60   |        | %    |
|   |   | ILQ620   | $CTR_{CEsat}$   |        | 60   |        | %    |
| Current transfer ratio (collector emitter)  | $I_F = \pm 5\text{ mA}$ , $V_{CE} = 5\text{ V}$           | ILD620   | $CTR_{CE}$      | 50     | 80   | 600    | %    |
|   |   | ILQ620   | $CTR_{CE}$      | 50     | 80   | 600    | %    |
| Current transfer ratio (collector emitter saturated)  | $I_F = \pm 1\text{ mA}$ , $V_{CE} = 0.4\text{ V}$         | ILD620GB | $CTR_{CEsat}$   | 30     |      |        | %    |
|   |   | ILQ620GB | $CTR_{CEsat}$   | 30     |      |        | %    |
| Current transfer ratio (collector emitter)  | $I_F = \pm 5\text{ mA}$ , $V_{CE} = 5\text{ V}$           | ILD620GB | $CTR_{CEsat}$   | 100    | 200  | 600    | %    |
|   |   | ILQ620GB | $CTR_{CEsat}$   | 100    | 200  | 600    | %    |

| SAFETY AND INSULATION RATED PARAMETERS                  |   |            |           |      |      |                    |  |
|---|---|------------|-----------|------|------|--------------------|--|
| PARAMETER   | TEST CONDITION  | SYMBOL     | MIN.      | TYP. | MAX. | UNIT               |  |
| Partial discharge test voltage - routine test           | 100 %, $t_{test} = 1\text{ s}$  | $V_{pd}$   | 1.669     |      |      | kV                 |  |
| Partial discharge test voltage - lot test (sample test) | $t_{Tr} = 60\text{ s}$ , $t_{test} = 10\text{ s}$ ,<br>(see figure 2)                         | $V_{IOTM}$ | 10        |      |      | kV                 |  |
|   |   | $V_{pd}$   | 1.424     |      |      | kV                 |  |
| Insulation resistance                                   | $V_{IO} = 500\text{ V}$   | $R_{IO}$   | $10^{12}$ |      |      | $\Omega$           |  |
|   | $V_{IO} = 500\text{ V}$ , $T_{amb} = 100\text{ }^{\circ}\text{C}$                             | $R_{IO}$   | $10^{11}$ |      |      | $\Omega$           |  |
|   | $V_{IO} = 500\text{ V}$ , $T_{amb} = 150\text{ }^{\circ}\text{C}$<br>(construction test only) | $R_{IO}$   | $10^9$    |      |      | $\Omega$           |  |
| Forward current   |   | $I_{si}$   |           |      | 275  | mA                 |  |
| Power dissipation                                       |   | $P_{SO}$   |           |      | 400  | mW                 |  |
| Rated impulse voltage                                   |   | $V_{IOTM}$ |           |      | 10   | kV                 |  |
| Safety temperature                                      |   | $T_{si}$   |           |      | 175  | $^{\circ}\text{C}$ |  |

**Note**

- According to DIN EN 60747-5-5 (VDE 0884) (see figure 2). This optocoupler is suitable for safe electrical isolation only within the safety ratings. Compliance with the safety ratings shall be ensured by means of suitable protective circuits.

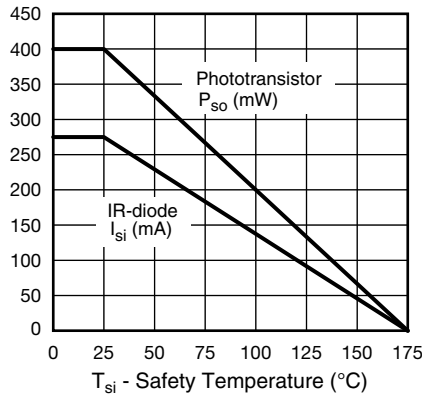

Fig. 1 - Derating Diagram

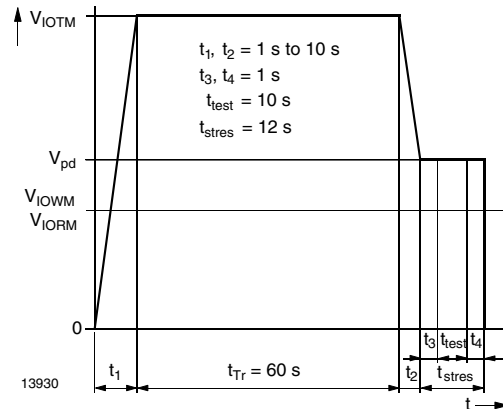

Fig. 2 - Test Pulse Diagram for Sample Test According to DIN EN 60747-5-2 (VDE 0884); IEC 60747-5-5

| <b>SWITCHING CHARACTERISTICS</b> ( $T_{amb} = 25$ °C, unless otherwise specified) |   |           |      |      |      |         |
|---|---|-----------|------|------|------|---------|
| PARAMETER   | TEST CONDITION  | SYMBOL    | MIN. | TYP. | MAX. | UNIT    |
| <b>NON-SATURATED</b>  |   |           |      |      |      |         |
| On time   | $I_F = \pm 10$ mA, $V_{CC} = 5$ V, $R_L = 75$ $\Omega$ , 50 % of $V_{PP}$   | $t_{on}$  |      | 3    |      | $\mu$ s |
| Rise time   | $I_F = \pm 10$ mA, $V_{CC} = 5$ V, $R_L = 75$ $\Omega$ , 50 % of $V_{PP}$   | $t_r$     |      | 20   |      | $\mu$ s |
| Off time  | $I_F = \pm 10$ mA, $V_{CC} = 5$ V, $R_L = 75$ $\Omega$ , 50 % of $V_{PP}$   | $t_{off}$ |      | 2.3  |      | $\mu$ s |
| Fall time   | $I_F = \pm 10$ mA, $V_{CC} = 5$ V, $R_L = 75$ $\Omega$ , 50 % of $V_{PP}$   | $t_f$     |      | 2    |      | $\mu$ s |
| Propagation H to L  | $I_F = \pm 10$ mA, $V_{CC} = 5$ V, $R_L = 75$ $\Omega$ , 50 % of $V_{PP}$   | $t_{PHL}$ |      | 1.1  |      | $\mu$ s |
| Propagation L to H  | $I_F = \pm 10$ mA, $V_{CC} = 5$ V, $R_L = 75$ $\Omega$ , 50 % of $V_{PP}$   | $t_{PLH}$ |      | 2.5  |      | $\mu$ s |
| <b>SATURATED</b>  |   |           |      |      |      |         |
| On time   | $I_F = \pm 10$ mA, $V_{CC} = 5$ V, $R_L = 1$ k $\Omega$ , $V_{TH} = 1.5$ V, | $t_{on}$  |      | 4.3  |      | $\mu$ s |
| Rise time   | $I_F = \pm 10$ mA, $V_{CC} = 5$ V, $R_L = 1$ k $\Omega$ , $V_{TH} = 1.5$ V, | $t_r$     |      | 2.8  |      | $\mu$ s |
| Off time  | $I_F = \pm 10$ mA, $V_{CC} = 5$ V, $R_L = 1$ k $\Omega$ , $V_{TH} = 1.5$ V, | $t_{off}$ |      | 2.5  |      | $\mu$ s |
| Fall time   | $I_F = \pm 10$ mA, $V_{CC} = 5$ V, $R_L = 1$ k $\Omega$ , $V_{TH} = 1.5$ V, | $t_f$     |      | 11   |      | $\mu$ s |
| Propagation H to L  | $I_F = \pm 10$ mA, $V_{CC} = 5$ V, $R_L = 1$ k $\Omega$ , $V_{TH} = 1.5$ V, | $t_{PHL}$ |      | 2.6  |      | $\mu$ s |
| Propagation L to H  | $I_F = \pm 10$ mA, $V_{CC} = 5$ V, $R_L = 1$ k $\Omega$ , $V_{TH} = 1.5$ V, | $t_{PLH}$ |      | 7.2  |      | $\mu$ s |

## TYPICAL CHARACTERISTICS (T<sub>amb</sub> = 25 °C, unless otherwise specified)

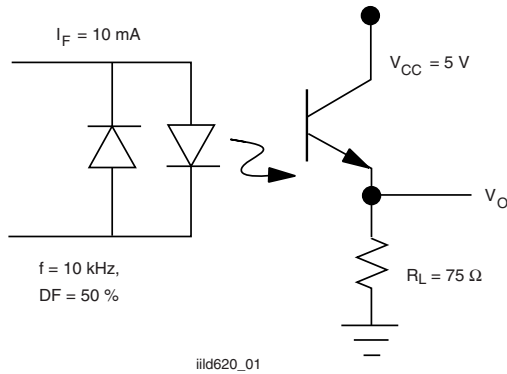

Fig. 3 - Non-Saturated Switching Timing

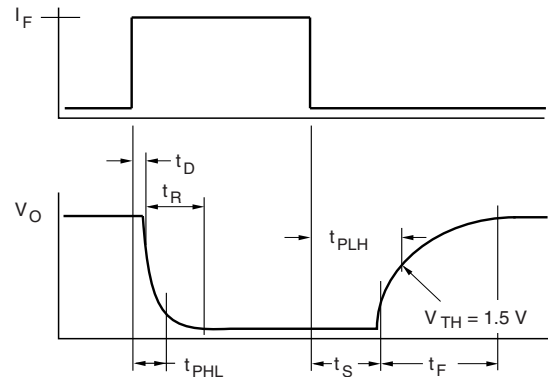

Fig. 6 - Saturated Switching Timing

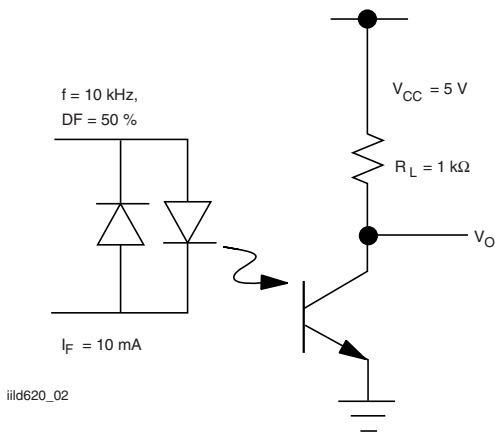

Fig. 4 - Saturated Switching Timing

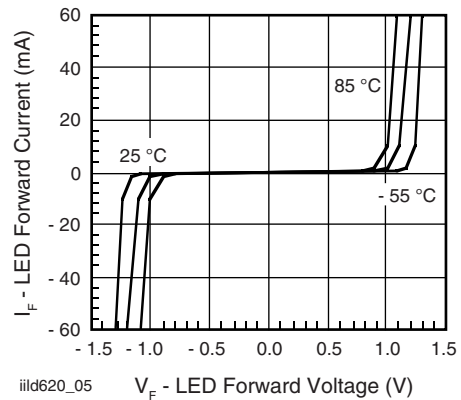

Fig. 7 - LED Forward Current vs. Forward Voltage

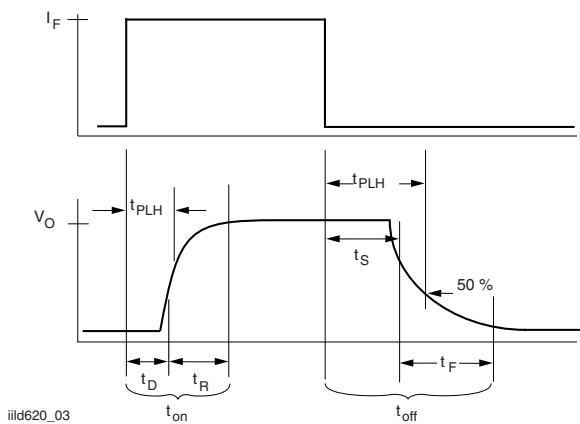

Fig. 5 - Non-Saturated Switching Timing

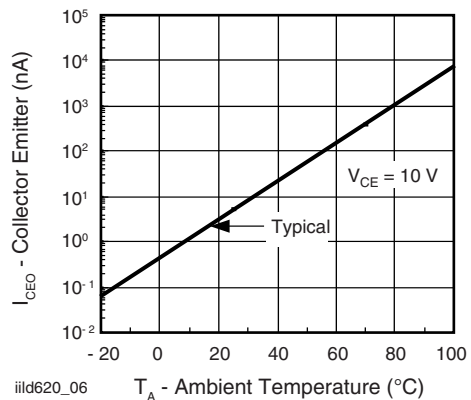

Fig. 8 - Collector Emitter Leakage vs. Temperature

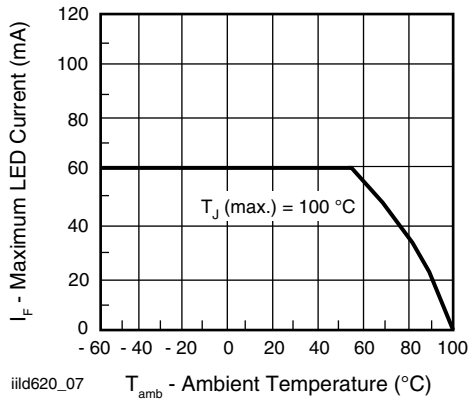

Fig. 9 - Maximum LED Current vs. Ambient Temperature

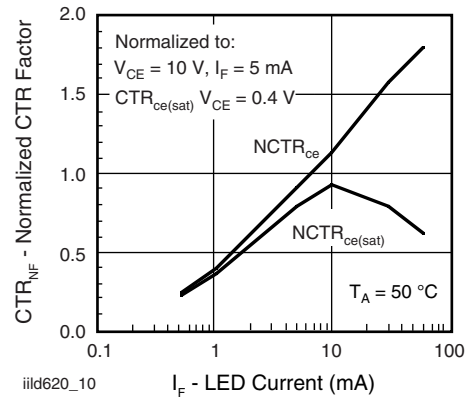

Fig. 12 - Normalization Factor for Non-Saturated and Saturated CTR vs.  $I_F$

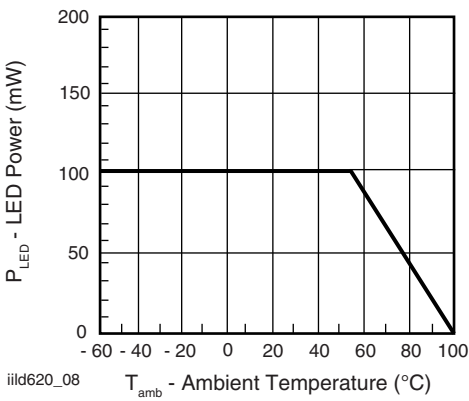

Fig. 10 - Maximum LED Power Dissipation

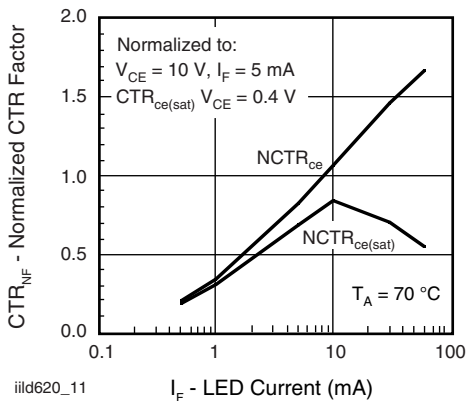

Fig. 13 - Normalization Factor for Non-Saturated and Saturated CTR vs.  $I_F$

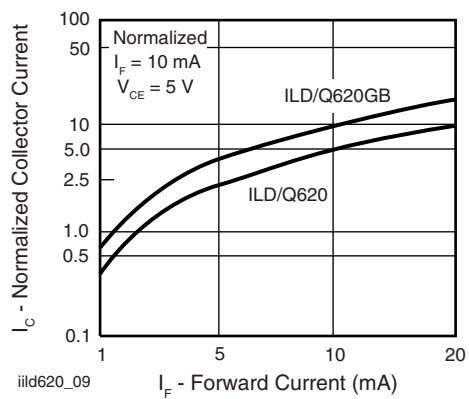

Fig. 11 - Collector Current vs. Diode Forward Current

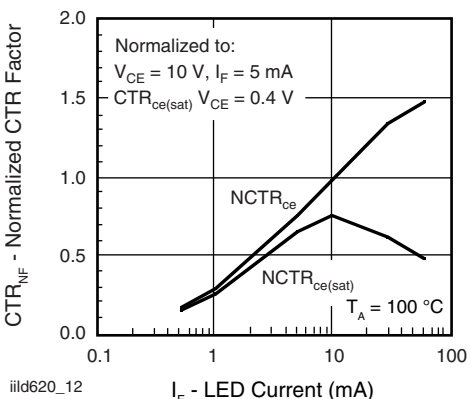

Fig. 14 - Normalization Factor for Non-Saturated and Saturated CTR vs.  $I_F$

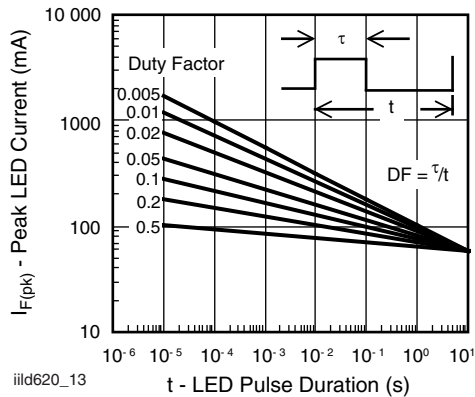

Fig. 15 - Peak LED Current vs. Pulse Duration,  $\tau$

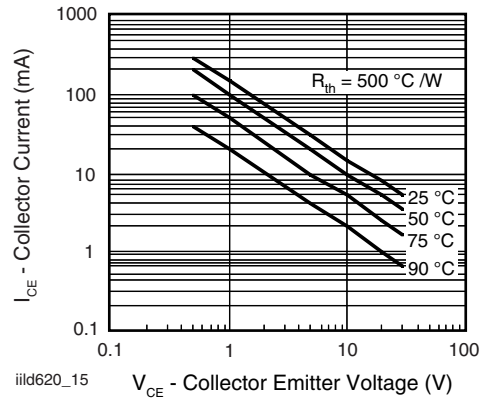

Fig. 17 - Maximum Collector Current vs. Collector Voltage

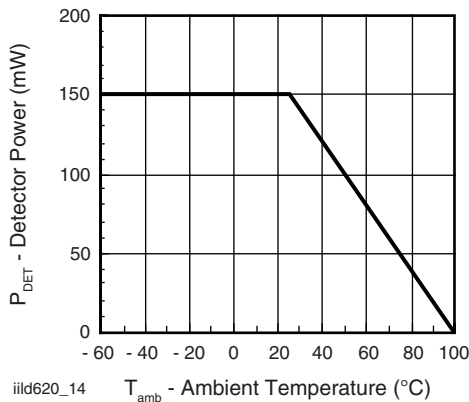
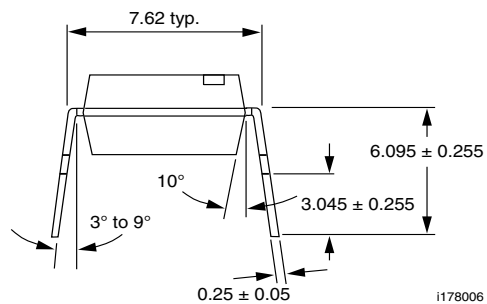
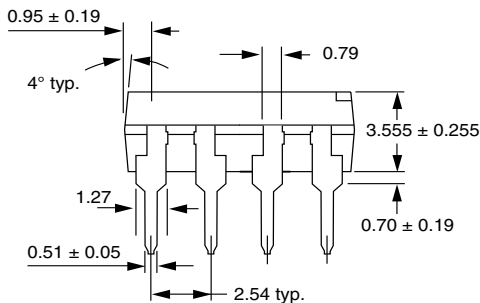
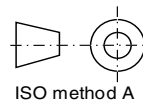
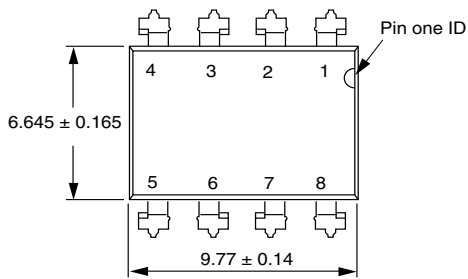
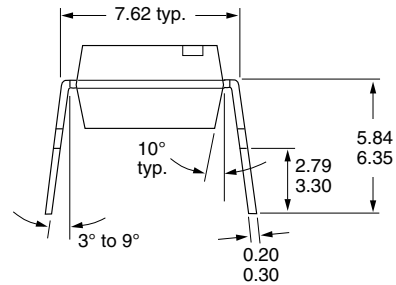
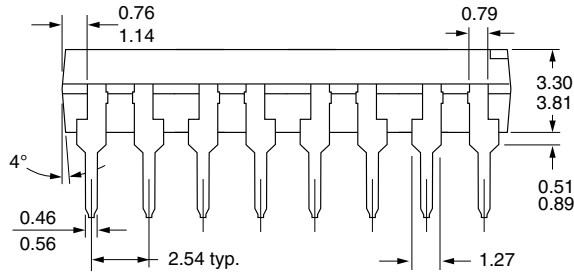
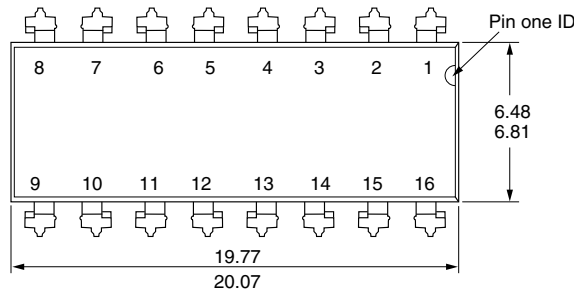

Fig. 16 - Maximum Detector Power Dissipation

**PACKAGE DIMENSIONS** in millimeters



i178006



i178007

Option 7

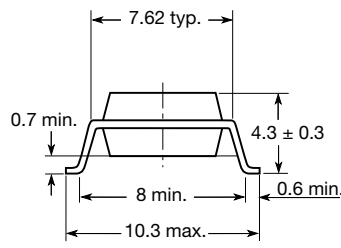

Option 9

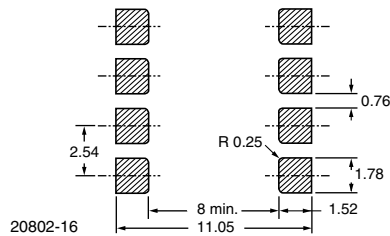
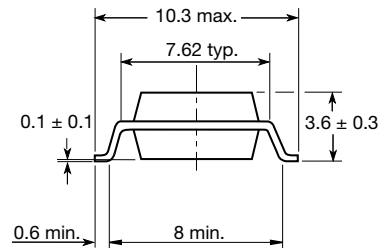

20802-16

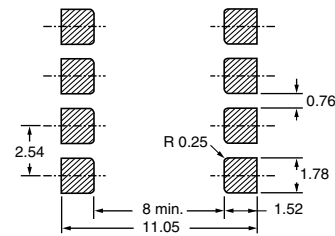

PACKAGE MARKING (example)

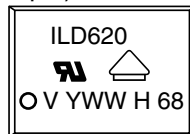

21764-95

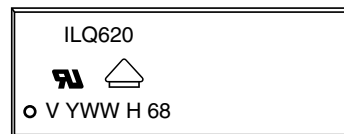

Notes

- Only option 1 and 7 reflected in the package marking.
- The VDE logo is only marked on option 1 parts.
- Tape and reel suffix (T) is not part of the package marking.





## Disclaimer

ALL PRODUCT, PRODUCT SPECIFICATIONS AND DATA ARE SUBJECT TO CHANGE WITHOUT NOTICE TO IMPROVE RELIABILITY, FUNCTION OR DESIGN OR OTHERWISE.

Vishay Intertechnology, Inc., its affiliates, agents, and employees, and all persons acting on its or their behalf (collectively, "Vishay"), disclaim any and all liability for any errors, inaccuracies or incompleteness contained in any datasheet or in any other disclosure relating to any product.

Vishay makes no warranty, representation or guarantee regarding the suitability of the products for any particular purpose or the continuing production of any product. To the maximum extent permitted by applicable law, Vishay disclaims (i) any and all liability arising out of the application or use of any product, (ii) any and all liability, including without limitation special, consequential or incidental damages, and (iii) any and all implied warranties, including warranties of fitness for particular purpose, non-infringement and merchantability.

Statements regarding the suitability of products for certain types of applications are based on Vishay's knowledge of typical requirements that are often placed on Vishay products in generic applications. Such statements are not binding statements about the suitability of products for a particular application. It is the customer's responsibility to validate that a particular product with the properties described in the product specification is suitable for use in a particular application. Parameters provided in datasheets and/or specifications may vary in different applications and performance may vary over time. All operating parameters, including typical parameters, must be validated for each customer application by the customer's technical experts. Product specifications do not expand or otherwise modify Vishay's terms and conditions of purchase, including but not limited to the warranty expressed therein.

Except as expressly indicated in writing, Vishay products are not designed for use in medical, life-saving, or life-sustaining applications or for any other application in which the failure of the Vishay product could result in personal injury or death. Customers using or selling Vishay products not expressly indicated for use in such applications do so at their own risk. Please contact authorized Vishay personnel to obtain written terms and conditions regarding products designed for such applications.

No license, express or implied, by estoppel or otherwise, to any intellectual property rights is granted by this document or by any conduct of Vishay. Product names and markings noted herein may be trademarks of their respective owners.

## Material Category Policy

**Vishay Intertechnology, Inc. hereby certifies that all its products that are identified as RoHS-Compliant fulfill the definitions and restrictions defined under Directive 2011/65/EU of The European Parliament and of the Council of June 8, 2011 on the restriction of the use of certain hazardous substances in electrical and electronic equipment (EEE) - recast, unless otherwise specified as non-compliant.**

**Please note that some Vishay documentation may still make reference to RoHS Directive 2002/95/EC. We confirm that all the products identified as being compliant to Directive 2002/95/EC conform to Directive 2011/65/EU.**

**Vishay Intertechnology, Inc. hereby certifies that all its products that are identified as Halogen-Free follow Halogen-Free requirements as per JEDEC JS709A standards. Please note that some Vishay documentation may still make reference to the IEC 61249-2-21 definition. We confirm that all the products identified as being compliant to IEC 61249-2-21 conform to JEDEC JS709A standards.**