

## “Low Side Chopper” IGBT SOT-227 (Warp 2 Speed IGBT), 70 A

**SOT-227**

PRODUCT SUMMARY	
$V_{CES}$	600 V
$I_C$ DC	70 A at 88 °C
$V_{CE(on)}$ typical at 70 A, 25 °C	2.23 V
$I_F$ DC	70 A at 86 °C
Speed	30 kHz to 150 kHz
Package	SOT-227
Circuit	Chopper low side switch

**FEATURES**

- NPT warp 2 speed IGBT technology with positive temperature coefficient
- Square RBSOA
- Low  $V_{CE(on)}$
- FRED Pt<sup>®</sup> hyperfast rectifier
- Fully isolated package
- Very low internal inductance ( $\leq 5$  nH typical)
- Industry standard outline
- UL approved file E78996 
- Material categorization: for definitions of compliance please see [www.vishay.com/doc?99912](http://www.vishay.com/doc?99912)

**RoHS  
COMPLIANT**
**BENEFITS**

- Designed for increased operating efficiency in power conversion: UPS, SMPS, welding, induction heating
- Easy to assemble and parallel
- Direct mounting to heatsink
- Plug-in compatible with other SOT-227 packages
- Lower conduction losses and switching losses
- Low EMI, requires less snubbing

ABSOLUTE MAXIMUM RATINGS				
PARAMETER	SYMBOL	TEST CONDITIONS	MAX.	UNITS
Collector to emitter voltage	$V_{CES}$		600	V
Continuous collector current	$I_C$	$T_C = 25\text{ °C}$	111	A
		$T_C = 80\text{ °C}$	76	
Pulsed collector current	$I_{CM}$		120	
Clamped inductive load current	$I_{LM}$		120	
Diode continuous forward current	$I_F$	$T_C = 25\text{ °C}$	113	
		$T_C = 80\text{ °C}$	75	
Peak diode forward current	$I_{FM}$		200	
Gate to emitter voltage	$V_{GE}$		$\pm 20$	V
Power dissipation, IGBT	$P_D$	$T_C = 25\text{ °C}$	447	W
		$T_C = 80\text{ °C}$	250	
Power dissipation, diode	$P_D$	$T_C = 25\text{ °C}$	236	
		$T_C = 80\text{ °C}$	132	
RMS isolation voltage	$V_{ISOL}$	Any terminal to case, $t = 1$ min	2500	V



<b>ELECTRICAL SPECIFICATIONS</b> ( $T_J = 25\text{ }^\circ\text{C}$ unless otherwise specified)						
PARAMETER	SYMBOL	TEST CONDITIONS	MIN.	TYP.	MAX.	UNITS
Collector to emitter breakdown voltage	$V_{BR(CES)}$	$V_{GE} = 0\text{ V}, I_C = 1\text{ mA}$	600	-	-	
Collector to emitter voltage	$V_{CE(on)}$	$V_{GE} = 15\text{ V}, I_C = 35\text{ A}$	-	1.69	1.88	V
		$V_{GE} = 15\text{ V}, I_C = 70\text{ A}$	-	2.23	2.44	
		$V_{GE} = 15\text{ V}, I_C = 35\text{ A}, T_J = 125\text{ }^\circ\text{C}$	-	2.07	2.31	
		$V_{GE} = 15\text{ V}, I_C = 70\text{ A}, T_J = 125\text{ }^\circ\text{C}$	-	2.89	3.21	
Gate threshold voltage	$V_{GE(th)}$	$V_{CE} = V_{GE}, I_C = 500\text{ }\mu\text{A}$	3	3.9	5	
Temperature coefficient of threshold voltage	$\Delta V_{GE(th)}/\Delta T_J$	$V_{CE} = V_{GE}, I_C = 1\text{ mA}$ ( $25\text{ }^\circ\text{C}$ to $125\text{ }^\circ\text{C}$ )	-	-9	-	mV/°C
Collector to emitter leakage current	$I_{CES}$	$V_{GE} = 0\text{ V}, V_{CE} = 600\text{ V}$	-	1	100	$\mu\text{A}$
		$V_{GE} = 0\text{ V}, V_{CE} = 600\text{ V}, T_J = 125\text{ }^\circ\text{C}$	-	0.07	2.0	mA
Diode reverse breakdown voltage	$V_{BR}$	$I_R = 1\text{ mA}$	600	-	-	V
Diode forward voltage drop	$V_{FM}$	$I_C = 35\text{ A}, V_{GE} = 0\text{ V}$	-	1.8	2.33	V
		$I_C = 70\text{ A}, V_{GE} = 0\text{ V}$	-	2.13	2.71	
		$I_C = 35\text{ A}, V_{GE} = 0\text{ V}, T_J = 125\text{ }^\circ\text{C}$	-	1.35	1.81	
		$I_C = 70\text{ A}, V_{GE} = 0\text{ V}, T_J = 125\text{ }^\circ\text{C}$	-	1.7	2.32	
Diode reverse leakage current	$I_{RM}$	$V_R = V_R$ rated	-	0.1	50	$\mu\text{A}$
		$T_J = 125\text{ }^\circ\text{C}, V_R = V_R$ rated	-	0.01	3	mA
Gate to emitter leakage current	$I_{GES}$	$V_{GE} = \pm 20\text{ V}$	-	-	$\pm 200$	nA

<b>SWITCHING CHARACTERISTICS</b> ( $T_J = 25\text{ }^\circ\text{C}$ unless otherwise specified)							
PARAMETER	SYMBOL	TEST CONDITIONS	MIN.	TYP.	MAX.	UNITS	
Total gate charge (turn-on)	$Q_g$	$I_C = 50\text{ A}, V_{CC} = 400\text{ V}, V_{GE} = 15\text{ V}$	-	320	-	nC	
Gate to emitter charge (turn-on)	$Q_{ge}$		-	42	-		
Gate to collector charge (turn-on)	$Q_{gc}$		-	110	-		
Turn-on switching loss	$E_{on}$	$I_C = 70\text{ A}, V_{CC} = 360\text{ V}, V_{GE} = 15\text{ V}, R_g = 5\text{ }\Omega, L = 500\text{ }\mu\text{H}, T_J = 25\text{ }^\circ\text{C}$  Energy losses include tail and diode recovery (see fig. 18)	-	1.15	-	mJ	
Turn-off switching loss	$E_{off}$		-	1.16	-		
Total switching loss	$E_{tot}$		-	2.31	-		
Turn-on switching loss	$E_{on}$		-	1.27	-		
Turn-off switching loss	$E_{off}$		-	1.28	-		
Total switching loss	$E_{tot}$		-	2.55	-		
Turn-on delay time	$t_{d(on)}$		$I_C = 70\text{ A}, V_{CC} = 360\text{ V}, V_{GE} = 15\text{ V}, R_g = 5\text{ }\Omega, L = 500\text{ }\mu\text{H}, T_J = 125\text{ }^\circ\text{C}$	-	208	-	ns
Rise time	$t_r$			-	69	-	
Turn-off delay time	$t_{d(off)}$			-	208	-	
Fall time	$t_f$			-	100	-	
Reverse bias safe operating area	RBSOA	$T_J = 150\text{ }^\circ\text{C}, I_C = 120\text{ A}, R_g = 22\text{ }\Omega, V_{GE} = 15\text{ V to } 0\text{ V}, V_{CC} = 400\text{ V}, V_P = 600\text{ V}$	Fullsquare				
Diode reverse recovery time	$t_{rr}$	$I_F = 50\text{ A}, di_F/dt = 200\text{ A}/\mu\text{s}, V_R = 200\text{ V}$	-	59	93	ns	
Diode peak reverse current	$I_{rr}$		-	4	6	A	
Diode recovery charge	$Q_{rr}$		-	118	279	nC	
Diode reverse recovery time	$t_{rr}$	$I_F = 50\text{ A}, di_F/dt = 200\text{ A}/\mu\text{s}, V_R = 200\text{ V}, T_J = 125\text{ }^\circ\text{C}$	-	130	159	ns	
Diode peak reverse current	$I_{rr}$		-	11	13	A	
Diode recovery charge	$Q_{rr}$		-	715	995	nC	



THERMAL AND MECHANICAL SPECIFICATIONS						
PARAMETER	SYMBOL	TEST CONDITIONS	MIN.	TYP.	MAX.	UNITS
Junction and storage temperature range	$T_J, T_{Stg}$		-40	-	150	°C
Junction to case	IGBT		-	-	0.28	°C/W
	Diode		-	-	0.53	
Case to heatsink	$R_{thCS}$	Flat, greased surface	-	0.05	-	
Weight			-	30	-	g
Mounting torque			-	-	1.3	Nm
Case style	SOT-227					

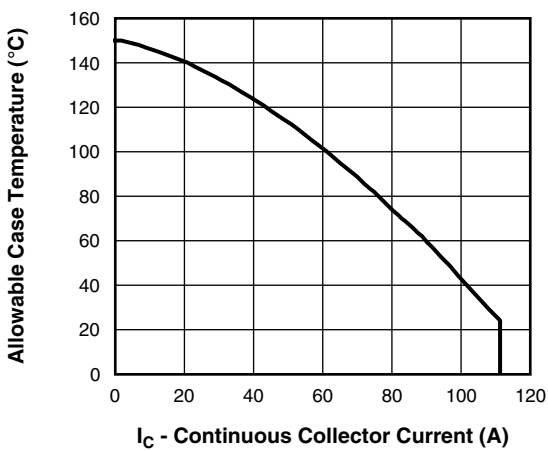

Fig. 1 - Maximum DC IGBT Collector Current vs. Case Temperature

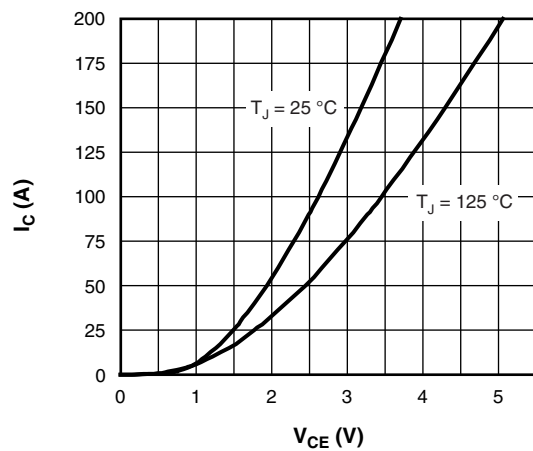

Fig. 3 - Typical IGBT Collector Current Characteristics

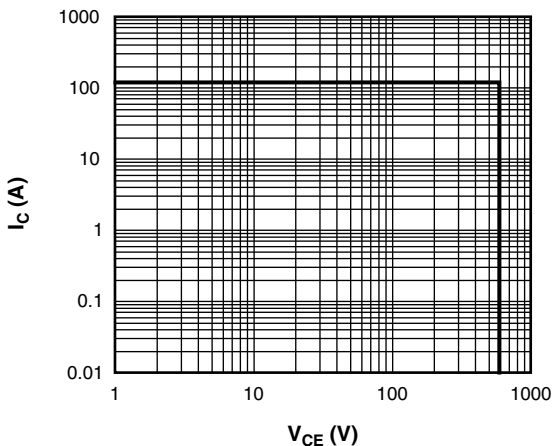

Fig. 2 - IGBT Reverse Bias SOA  
 $T_J = 150^\circ\text{C}, V_{GE} = 15\text{ V}$

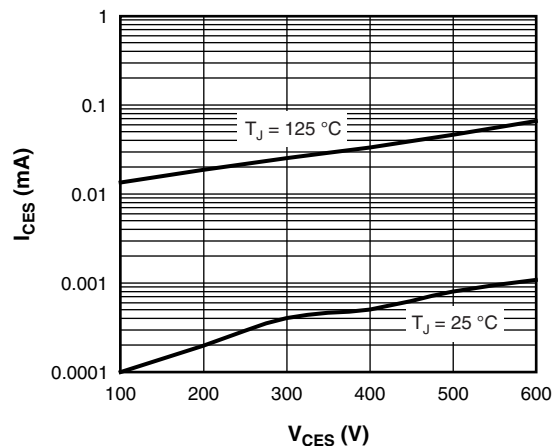

Fig. 4 - Typical IGBT Zero Gate Voltage Collector Current

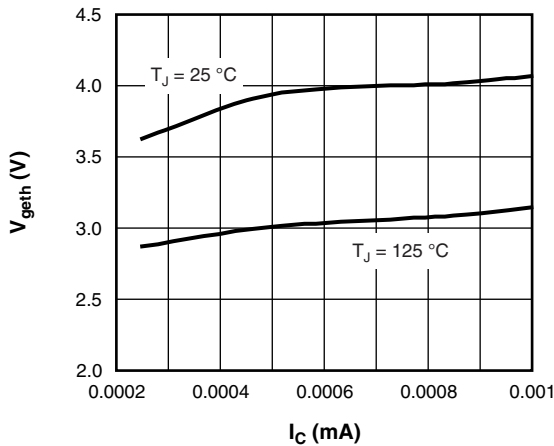

Fig. 5 - Typical IGBT Threshold Voltage

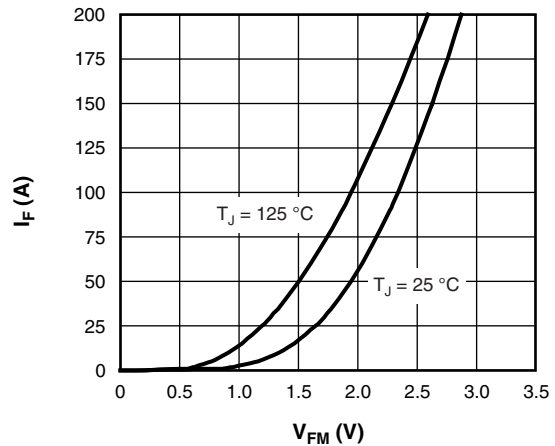

Fig. 8 - Typical Diode Forward Characteristics

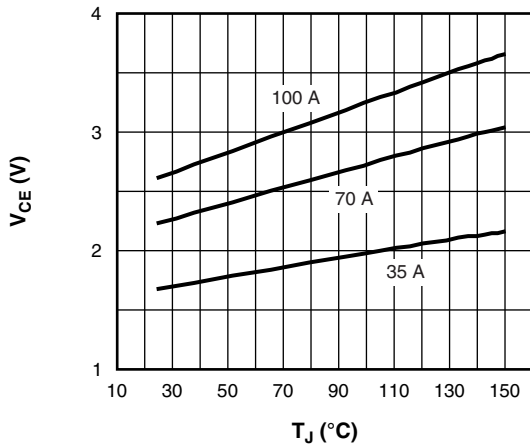

Fig. 6 - Typical IGBT Collector to Emitter Voltage vs. Junction Temperature,  $V_{GE} = 15\text{ V}$

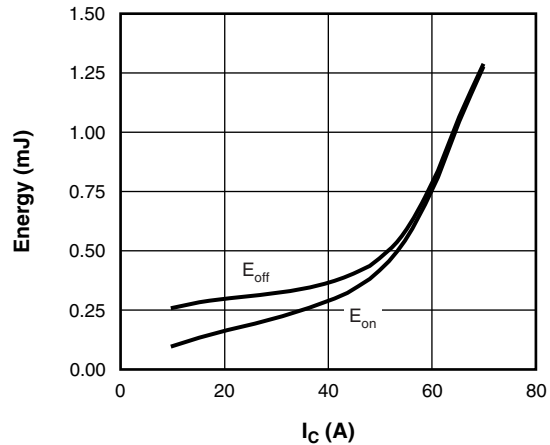

Fig. 9 - Typical IGBT Energy Loss vs.  $I_C$   
 $T_J = 125\text{ °C}$ ,  $L = 500\text{ }\mu\text{H}$ ,  $V_{CC} = 360\text{ V}$ ,  
 $R_g = 5\text{ }\Omega$ ,  $V_{GE} = 15\text{ V}$

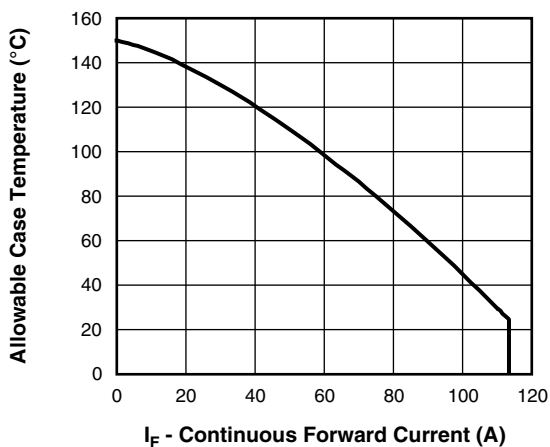

Fig. 7 - Maximum DC Forward Current vs. Case Temperature

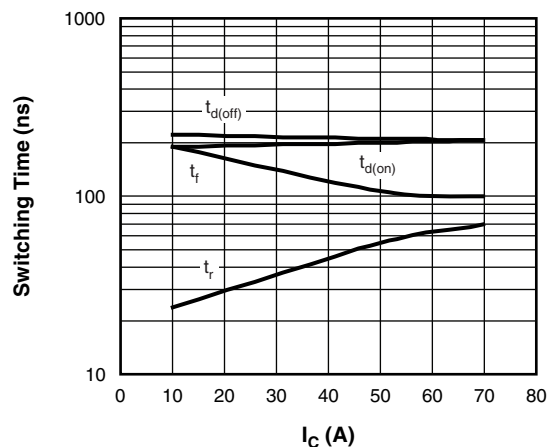

Fig. 10 - Typical IGBT Switching Time vs.  $I_C$   
 $T_J = 125\text{ °C}$ ,  $L = 500\text{ }\mu\text{H}$ ,  $V_{CC} = 360\text{ V}$ ,  
 $R_g = 5\text{ }\Omega$ ,  $V_{GE} = 15\text{ V}$

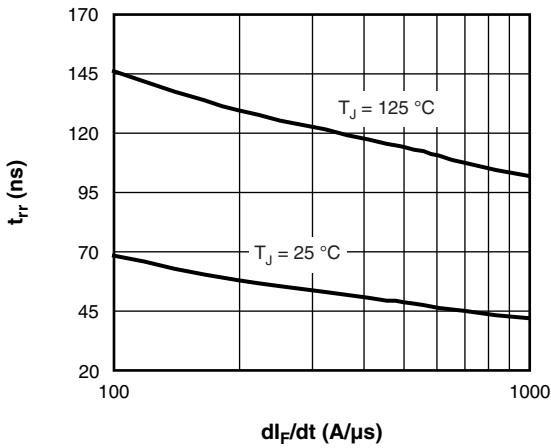

Fig. 11 - Typical  $t_{rr}$  Diode vs.  $dI_F/dt$   
 $V_R = 200\text{ V}$ ,  $I_F = 50\text{ A}$

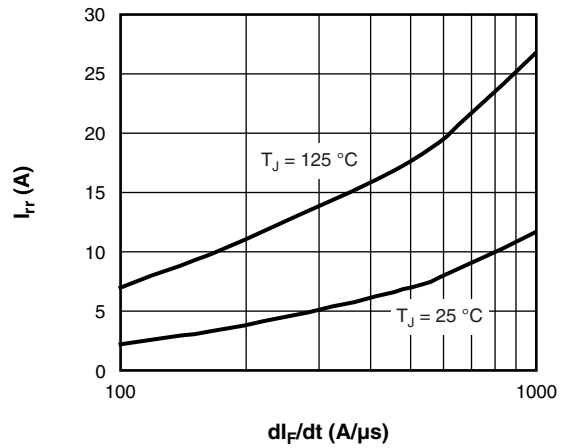

Fig. 12 - Typical  $I_{rr}$  Diode vs.  $dI_F/dt$   
 $V_{RR} = 200\text{ V}$ ,  $I_F = 50\text{ A}$

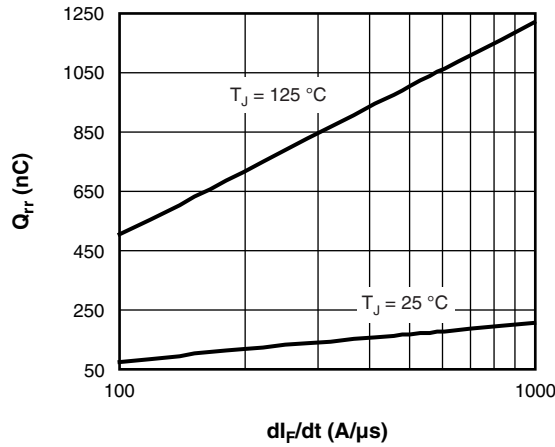

Fig. 13 - Typical  $Q_{rr}$  Diode vs.  $dI_F/dt$   
 $V_R = 200\text{ V}$ ,  $I_F = 50\text{ A}$

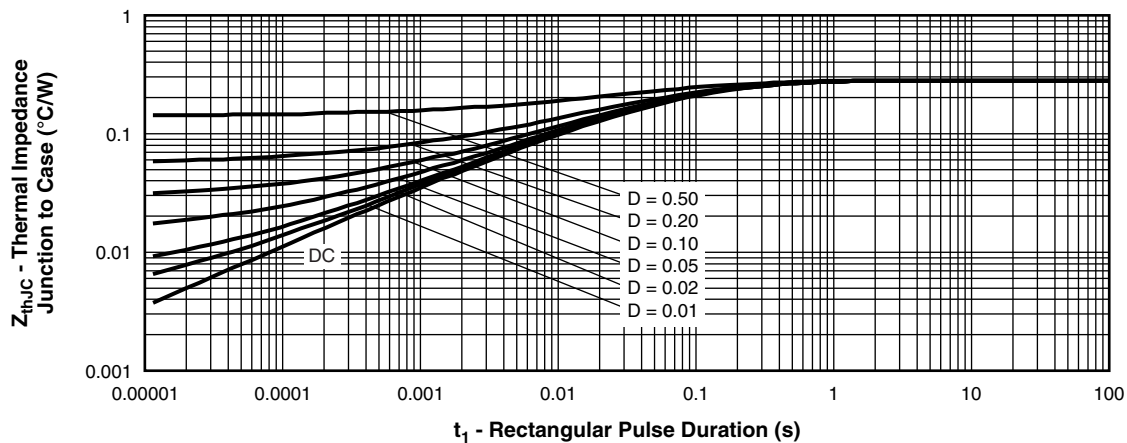

Fig. 14 - Maximum Thermal Impedance  $Z_{thJC}$  Characteristics (IGBT)

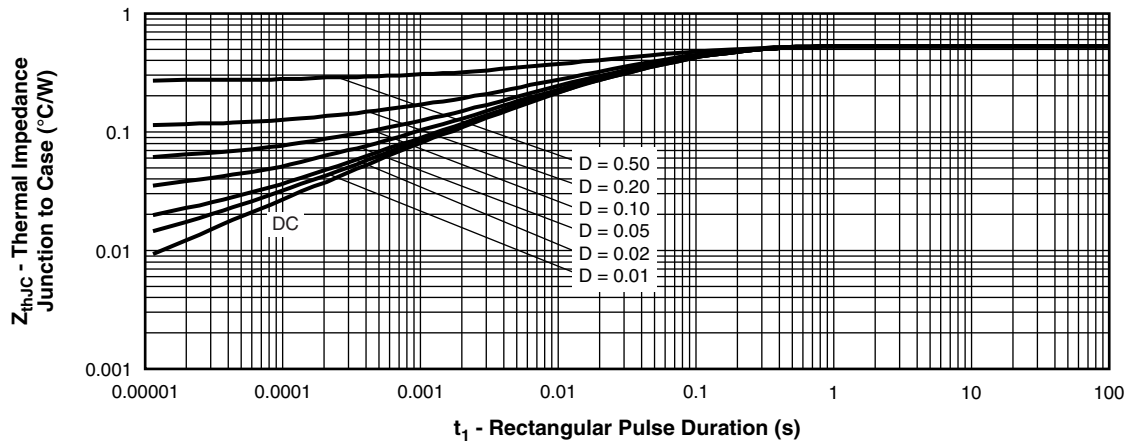

Fig. 15 - Maximum Thermal Impedance  $Z_{thJC}$  Characteristics (DIODE)

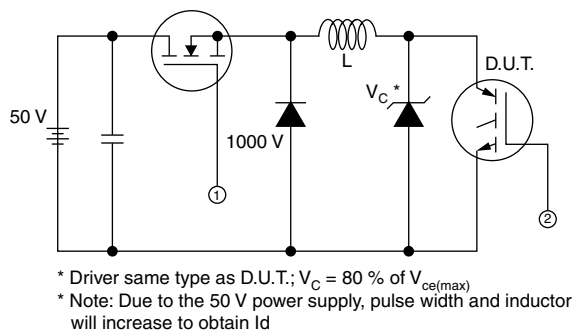

Fig. 16 - Clamped Inductive Load Test Circuit

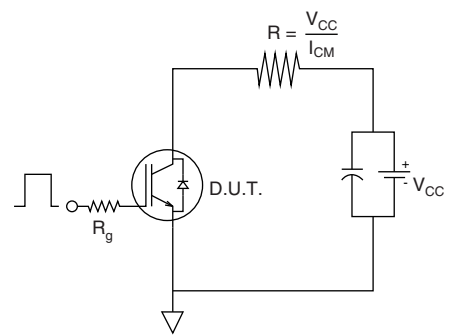

Fig. 17 - Pulsed Collector Current Test Circuit

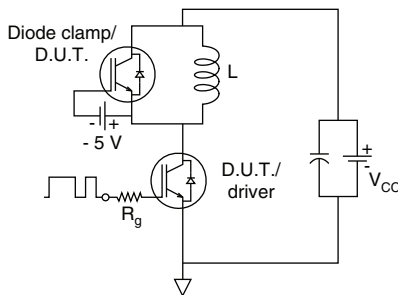

Fig. 18 - Switching Loss Test Circuit

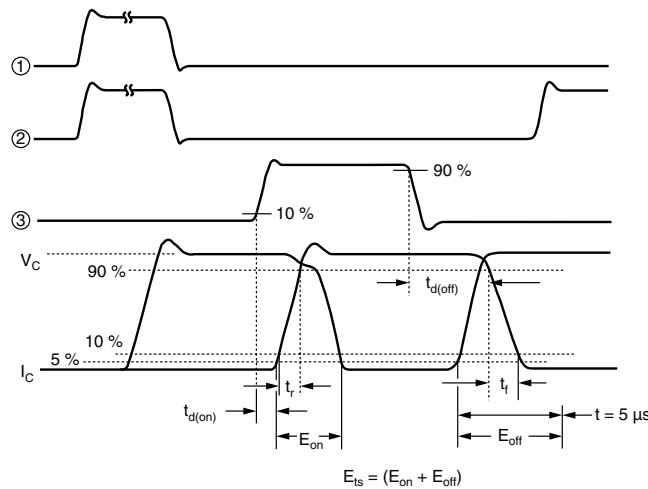

Fig. 19 - Switching Loss Waveforms Test Circuit

**ORDERING INFORMATION TABLE**

Device code	<b>VS-</b>	<b>G</b>	<b>B</b>	<b>70</b>	<b>L</b>	<b>A</b>	<b>60</b>	<b>U</b>	<b>F</b>
	①	②	③	④	⑤	⑥	⑦	⑧	⑨

- 1** - Vishay Semiconductors product
- 2** - Insulated Gate Bipolar Transistor (IGBT)
- 3** - B = IGBT Generation 5
- 4** - Current rating (70 = 70 A)
- 5** - Circuit configuration (L = Low Side Chopper)
- 6** - Package indicator (A = SOT-227)
- 7** - Voltage rating (60 = 600 V)
- 8** - Speed/type (U = Ultrafast IGBT)
- 9** - F = F/W FRED Pt® diode

**CIRCUIT CONFIGURATION**

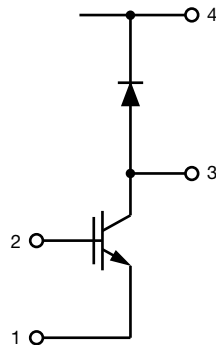

LINKS TO RELATED DOCUMENTS	
Dimensions	<a href="http://www.vishay.com/doc?95036">http://www.vishay.com/doc?95036</a>
Packaging information	<a href="http://www.vishay.com/doc?95037">http://www.vishay.com/doc?95037</a>

## SOT-227

**DIMENSIONS** in millimeters (inches)

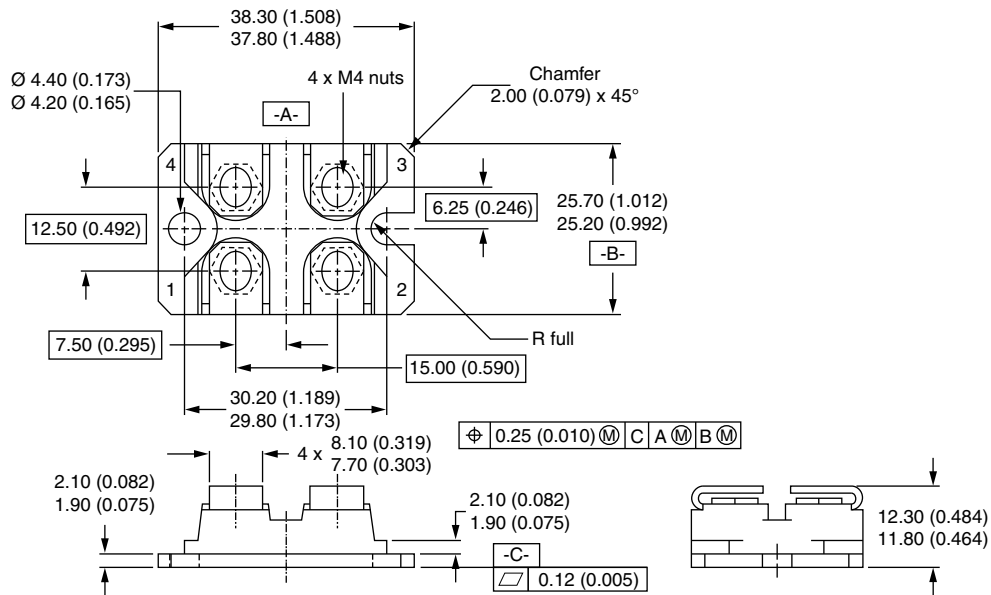

### Notes

- Dimensioning and tolerancing per ANSI Y14.5M-1982
- Controlling dimension: millimeter





## Disclaimer

ALL PRODUCT, PRODUCT SPECIFICATIONS AND DATA ARE SUBJECT TO CHANGE WITHOUT NOTICE TO IMPROVE RELIABILITY, FUNCTION OR DESIGN OR OTHERWISE.

Vishay Intertechnology, Inc., its affiliates, agents, and employees, and all persons acting on its or their behalf (collectively, "Vishay"), disclaim any and all liability for any errors, inaccuracies or incompleteness contained in any datasheet or in any other disclosure relating to any product.

Vishay makes no warranty, representation or guarantee regarding the suitability of the products for any particular purpose or the continuing production of any product. To the maximum extent permitted by applicable law, Vishay disclaims (i) any and all liability arising out of the application or use of any product, (ii) any and all liability, including without limitation special, consequential or incidental damages, and (iii) any and all implied warranties, including warranties of fitness for particular purpose, non-infringement and merchantability.

Statements regarding the suitability of products for certain types of applications are based on Vishay's knowledge of typical requirements that are often placed on Vishay products in generic applications. Such statements are not binding statements about the suitability of products for a particular application. It is the customer's responsibility to validate that a particular product with the properties described in the product specification is suitable for use in a particular application. Parameters provided in datasheets and/or specifications may vary in different applications and performance may vary over time. All operating parameters, including typical parameters, must be validated for each customer application by the customer's technical experts. Product specifications do not expand or otherwise modify Vishay's terms and conditions of purchase, including but not limited to the warranty expressed therein.

Except as expressly indicated in writing, Vishay products are not designed for use in medical, life-saving, or life-sustaining applications or for any other application in which the failure of the Vishay product could result in personal injury or death. Customers using or selling Vishay products not expressly indicated for use in such applications do so at their own risk. Please contact authorized Vishay personnel to obtain written terms and conditions regarding products designed for such applications.

No license, express or implied, by estoppel or otherwise, to any intellectual property rights is granted by this document or by any conduct of Vishay. Product names and markings noted herein may be trademarks of their respective owners.

## Material Category Policy

**Vishay Intertechnology, Inc. hereby certifies that all its products that are identified as RoHS-Compliant fulfill the definitions and restrictions defined under Directive 2011/65/EU of The European Parliament and of the Council of June 8, 2011 on the restriction of the use of certain hazardous substances in electrical and electronic equipment (EEE) - recast, unless otherwise specified as non-compliant.**

**Please note that some Vishay documentation may still make reference to RoHS Directive 2002/95/EC. We confirm that all the products identified as being compliant to Directive 2002/95/EC conform to Directive 2011/65/EU.**

**Vishay Intertechnology, Inc. hereby certifies that all its products that are identified as Halogen-Free follow Halogen-Free requirements as per JEDEC JS709A standards. Please note that some Vishay documentation may still make reference to the IEC 61249-2-21 definition. We confirm that all the products identified as being compliant to IEC 61249-2-21 conform to JEDEC JS709A standards.**