



Features

- Anti-surge
- Wide resistance range
- RoHS compliant*

Applications

- Pulse power applications
- High voltage applications
- Consumer electronics
- Telecommunications
- Power supplies

CRS Series - High Power Anti-Surge Chip Resistor

Electrical Characteristics

Characteristic	CRS0805	CRS1206	CRS2010	CRS2512
Power Rating @ 70°C	0.25 W	0.5 W	1 W	2 W
Operating Temperature Range	-55 °C to +155 °C			
Maximum Working Voltage	150 V	200 V	200 V	300 V
Maximum Overload Voltage	300 V	400 V	400 V	600 V
Resistance Range / Temperature Coefficient	1 to 9.9 ohms / ±200 PPM/°C 10 ohms to 1 megohm / ±100 PPM/°C			
Tolerance / Standard Resistance Values	1 % / E96 + E24 5 % / E24			

Performance Characteristics

Test	Conditions	Specification
Short Time Overload	2 times rated voltage or maximum overload voltage for 5 seconds.	$\Delta R \leq \pm(2\% + 0.1 \Omega)$
Solderability	245 ±5 °C for 3 ±0.5 seconds.	Over 95 % coverage
Resistance to Solder Heat	260 ±5 °C for 10 ± 1 seconds.	$\Delta R \leq \pm(1\% + 0.1 \Omega)$
Load Life Humidity	40 ±2 °C, 90 to 95 %. 1.5 hours ON, 0.5 hours OFF for 1000 hours at rated power.	$\Delta R \leq \pm(3\% + 0.1 \Omega)$
Load Life	70 °C. 1.5 hours ON, 0.5 hours OFF for 1000 hours at rated power.	$\Delta R \leq \pm(3\% + 0.1 \Omega)$
Temperature Cycle	-55 °C (30 min.), +25 °C (2~3 min.), +155 °C (30 min.), +25 °C (2~3 min.) for five cycles.	$\Delta R \leq \pm(1\% + 0.05 \Omega)$

Recommended Solder Pad Layout

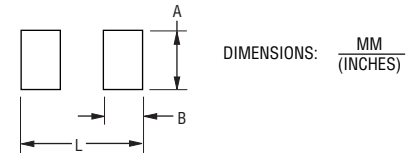

Model	Dimension		
	A	B	L
CRS0805	1.30 (0.051)	1.15 (0.045)	3.50 (0.138)
CRS1206	1.80 (0.071)	1.30 (0.051)	4.70 (0.185)
CRS2010	3.00 (0.118)	1.50 (0.059)	6.80 (0.268)
CRS2512	3.70 (0.146)	2.45 (0.096)	7.60 (0.299)

Construction

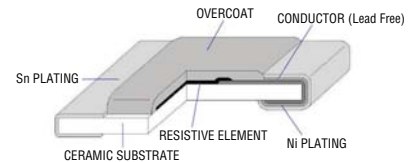

Derating Curve

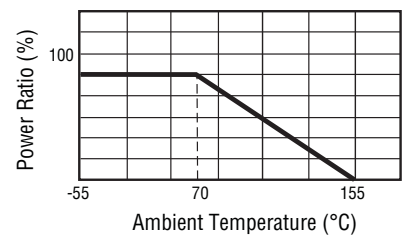

Product Dimensions

Model	Dimension				
	A	B	C	D	T
CRS0805	2.00 ± 0.10 (0.079 ± 0.004)	1.25 ± 0.10 (0.049 ± 0.004)	0.40 ± 0.20 (0.016 ± 0.008)	0.40 ± 0.20 (0.016 ± 0.008)	0.50 ± 0.10 (0.020 ± 0.004)
CRS1206	3.10 ± 0.10 (0.122 ± 0.004)	1.60 ± 0.10 (0.063 ± 0.004)	0.50 ± 0.20 (0.020 ± 0.008)	0.50 ± 0.20 (0.020 ± 0.008)	0.55 ± 0.10 (0.022 ± 0.004)
CRS2010	5.00 ± 0.20 (0.197 ± 0.008)	2.50 ± 0.20 (0.098 ± 0.008)	0.60 ± 0.25 (0.024 ± 0.010)	0.60 ± 0.25 (0.024 ± 0.010)	0.55 ± 0.10 (0.022 ± 0.004)
CRS2512	6.40 ± 0.20 (0.252 ± 0.008)	3.20 ± 0.20 (0.126 ± 0.008)	0.60 ± 0.25 (0.024 ± 0.010)	1.80 ± 0.25 (0.071 ± 0.010)	0.60 ± 0.15 (0.024 ± 0.006)

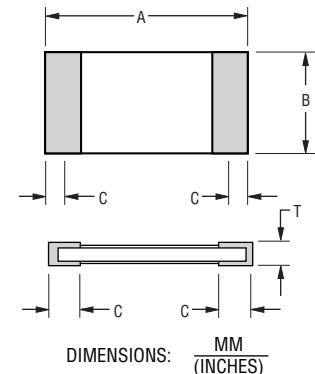

*RoHS Directive 2002/95/EC Jan. 27, 2003 including annex and RoHS Recast 2011/65/EU June 8, 2011.

Specifications are subject to change without notice.

The device characteristics and parameters in this data sheet can and do vary in different applications and actual device performance may vary over time. Users should verify actual device performance in their specific applications.

CRS Series - High Power Anti-Surge Chip Resistor



Surge Performance

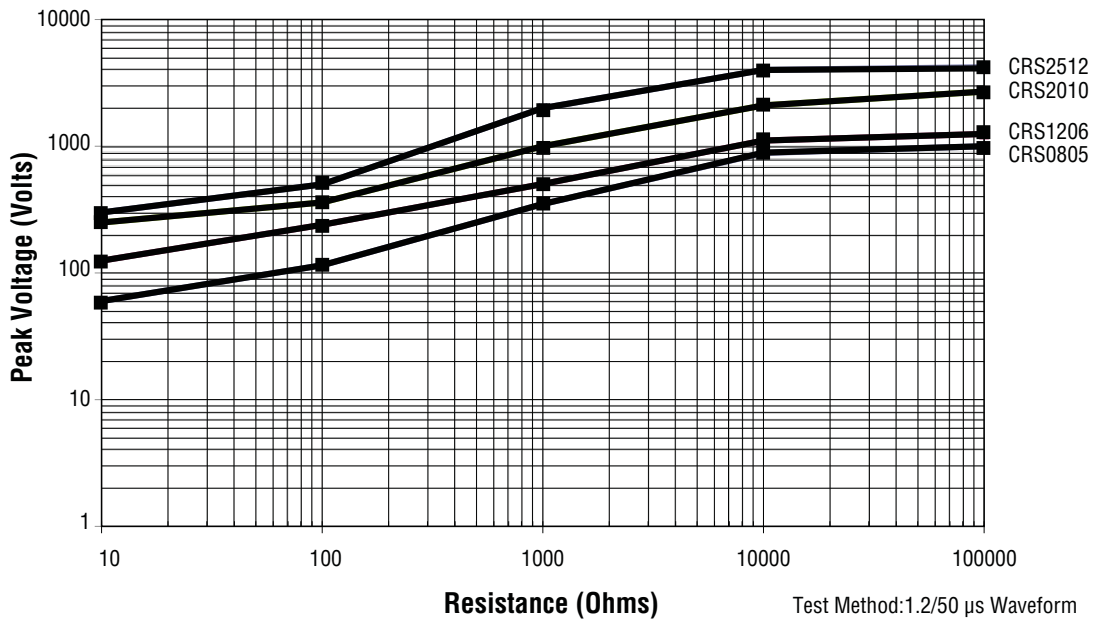
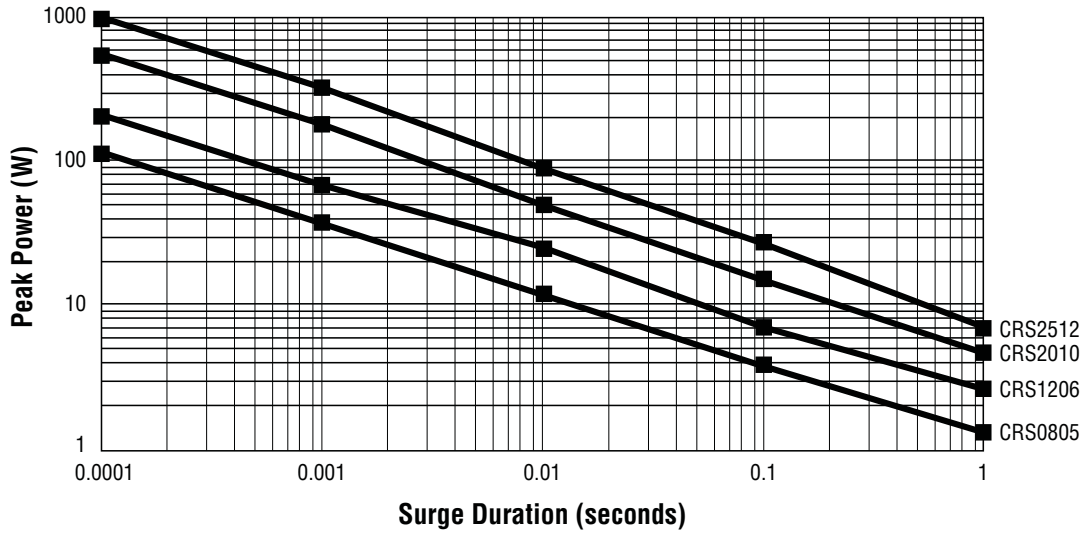

Test Method: 1.2/50 μ s Waveform
5 Pulses at 12 Second Intervals

Specifications are subject to change without notice. The device characteristics and parameters in this data sheet can and do vary in different applications and actual device performance may vary over time. Users should verify actual device performance in their specific applications.

CRS Series - High Power Anti-Surge Chip Resistor

BOURNS®

Soldering Profile

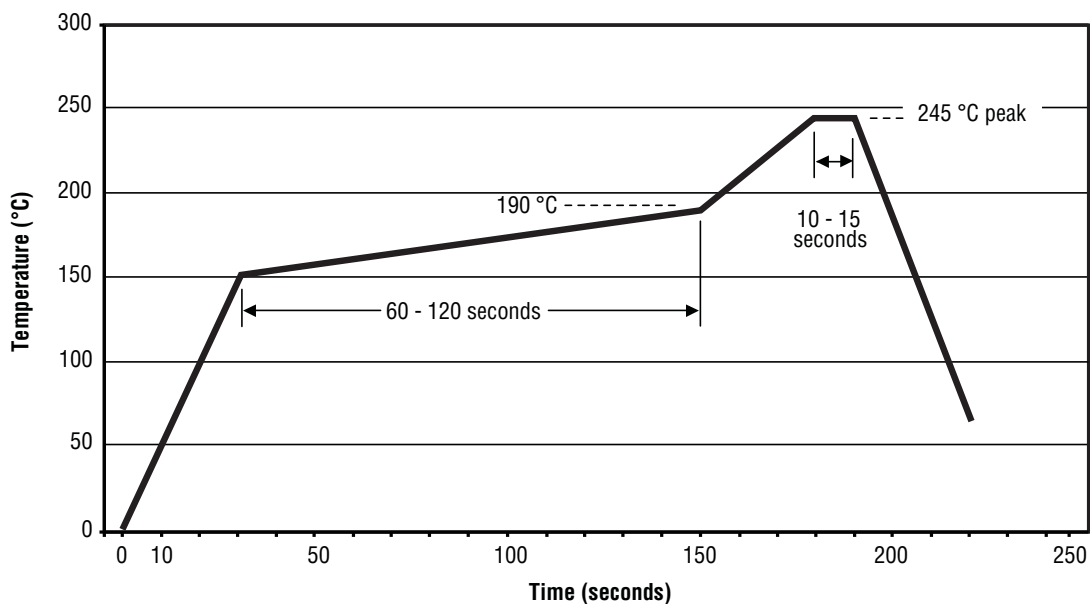

How to Order

CRS 2512 - F X - 24R3 E LF

Model	_____	_____	_____	_____	_____	_____
CRS = Anti-Surge Chip Resistor						
Size	_____	_____	_____	_____	_____	_____
0805						
1206						
2010						
2512						
Resistance Tolerance	_____	_____	_____	_____	_____	_____
F = ±1 %						
J = ±5 %						
TCR	_____	_____	_____	_____	_____	_____
X = ±100 PPM/°C						
W = ±200 PPM/°C						
Resistance Value	_____	_____	_____	_____	_____	_____
1% Tolerance:						
<100 ohms "R" represents decimal point (example: 24R3 = 24.3 ohms)						
≥100 ohms..... First three digits are significant, fourth digit represents number of zeros to follow (example: 8252 = 82.5K ohms)						
5% Tolerance:						
<10 ohms "R" represents decimal point (example: 4R7 = 4.7 ohms)						
≥10 ohms..... First two digits are significant, third digit represents number of zeros to follow (example: 474 = 470K ohms)						
Packaging	_____	_____	_____	_____	_____	_____
E = 5,000 pieces per 7-inch reel (CRS0805, CRS1206)						
4,000 pieces per 7-inch reel (CRS2010, CRS2512)						
Termination	_____	_____	_____	_____	_____	_____
LF = Tin-plated (RoHS Compliant)						

Specifications are subject to change without notice.
 The device characteristics and parameters in this data sheet can and do vary in different applications and actual device performance may vary over time.
 Users should verify actual device performance in their specific applications.

CRS Series - High Power Anti-Surge Chip Resistor

BOURNS®

Packaging Dimensions (Conforms to EIA RS-481A)

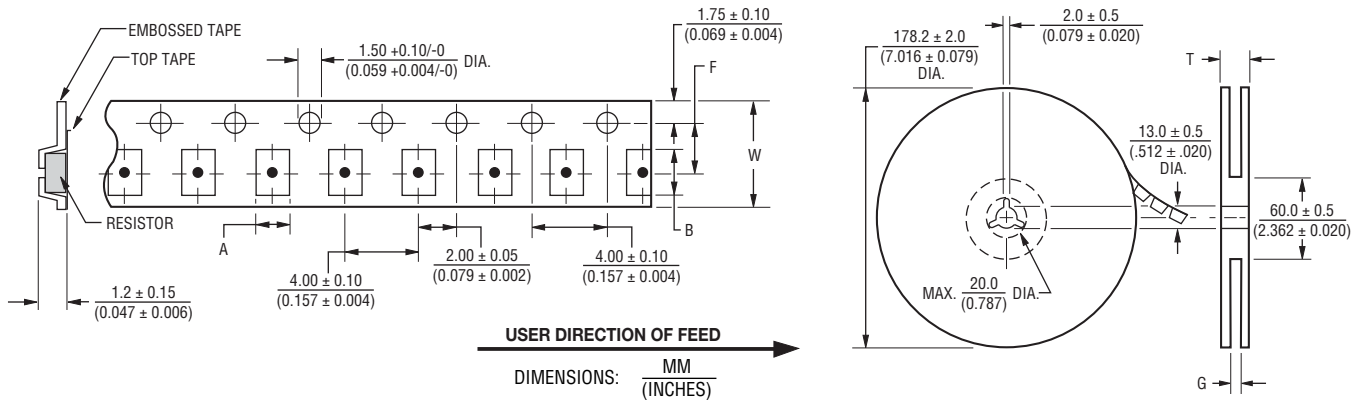

Model	Dimension			
	A	B	F	W
CRS0805	$\frac{1.65 \pm 0.20}{(0.065 \pm 0.008)}$	$\frac{2.40 \pm 0.20}{(0.094 \pm 0.008)}$	$\frac{3.50 \pm 0.05}{(0.138 \pm 0.002)}$	$\frac{8.00 \pm 0.30}{(0.315 \pm 0.012)}$
CRS1206	$\frac{2.00 \pm 0.20}{(0.079 \pm 0.008)}$	$\frac{3.60 \pm 0.10}{(0.142 \pm 0.004)}$	$\frac{3.50 \pm 0.05}{(0.138 \pm 0.002)}$	$\frac{8.00 \pm 0.30}{(0.315 \pm 0.012)}$
CRS2010	$\frac{2.80 \pm 0.20}{(0.110 \pm 0.008)}$	$\frac{5.50 \pm 0.20}{(0.217 \pm 0.008)}$	$\frac{5.50 \pm 0.05}{(0.217 \pm 0.002)}$	$\frac{12.00 \pm 0.30}{(0.472 \pm 0.012)}$
CRS2512	$\frac{3.50 \pm 0.20}{(0.138 \pm 0.008)}$	$\frac{6.70 \pm 0.20}{(0.264 \pm 0.008)}$	$\frac{5.50 \pm 0.05}{(0.217 \pm 0.002)}$	$\frac{12.00 \pm 0.30}{(0.472 \pm 0.012)}$

Model	Pcs. per Reel	Dimension	
		G	T (MAX.)
CRS0805	5,000	$\frac{10.00 \pm 1.50}{0.394 \pm 0.059}$	$\frac{20.00}{(0.587)}$
CRS1206			
CRS2010	4,000	$\frac{13.80 \pm 1.50}{(0.543 \pm 0.059)}$	$\frac{16.70}{(0.657)}$
CRS2512			

BOURNS®

Asia-Pacific: Tel: +886-2 2562-4117 • Fax: +886-2 2562-4116

EMEA: Tel: +36 88 520 390 • Fax: +36 88 520 211

The Americas: Tel: +1-951 781-5500 • Fax: +1-951 781-5700

www.bourns.com

REV. 05/15

Specifications are subject to change without notice.
The device characteristics and parameters in this data sheet can and do vary in different applications and actual device performance may vary over time.
Users should verify actual device performance in their specific applications.