

2-conductor through terminal block; suitable for Ex e II applications

Item No.: 2006-1201



2-conductor through terminal block; suitable for Ex e II applications

Marking

RoHS ✓
Compliant

Business data

Supplier	WAGO
Item no.	2006-1201
GTIN / EAN	4017332999649
Content	1
Order amount	50
Customer item number	

Notes

Technical data

Miscellaneous

Total number of connection points	2
Total number of potentials	1
Color	gray
Ratings according to 1	IEC/EN 60947-7-1
Pollution degree (1)	3
Rated voltage EN (1) [V]	800 [V]
Rated surge voltage (1) [kV]	8 [kV]
Nominal current [A]	41 [A]
Nominal current (2) [A]	57 [A]
Rated voltage EN (Ex e II) [V]	550 [V]

Technical data	
<i>Nominal current (Ex e II) [A]</i>	<i>38 [A]</i>
<i>Nominal current (Ex e II) with jumper [A]</i>	<i>33 [A]</i>
<i>Connection technology (1)</i>	<i>Push-in CAGE CLAMP®</i>
<i>Nominal cross section 1</i>	<i>6 mm²</i>
<i>Solid sizes 1</i>	<i>0.5 ... 10 mm² / 20 ... 8 AWG</i>
<i>solid, directly pluggable 1</i>	<i>1 ... 10 mm² / 14 ... 8 AWG</i>
<i>Fine-stranded wires 1</i>	<i>0.5 ... 10 mm² / 20 ... 8 AWG</i>
<i>min. fine-stranded with insulated ferrule, push-in terminati</i>	<i>1.5 mm² / 16 AWG</i>
<i>Strip length 1</i>	<i>13 ... 15 mm / 0.51 ... 0.59 in</i>
<i>Type of wiring</i>	<i>Front-entry wiring</i>
<i>Design</i>	<i>horizontal</i>
<i>Marking level</i>	<i>Center/Side marking</i>
<i>Insulating material</i>	<i>Polyamide 66 (PA 66)</i>
<i>Fire load [MJ]</i>	<i>0.154 [MJ]</i>
<i>Weight [g]</i>	<i>8.893 [g]</i>
<i>Width</i>	<i>7.5 mm / 0.295 in</i>
<i>Height from upper-edge of DIN-rail [mm]</i>	<i>32.9 [mm]</i>
<i>Height from upper-edge of DIN-rail</i>	<i>32.9 mm / 1.295 in</i>
<i>Length</i>	<i>57.5 mm / 2.264 in</i>
<i>Type of mounting</i>	<i>DIN 35 rail</i>

Images & drawings

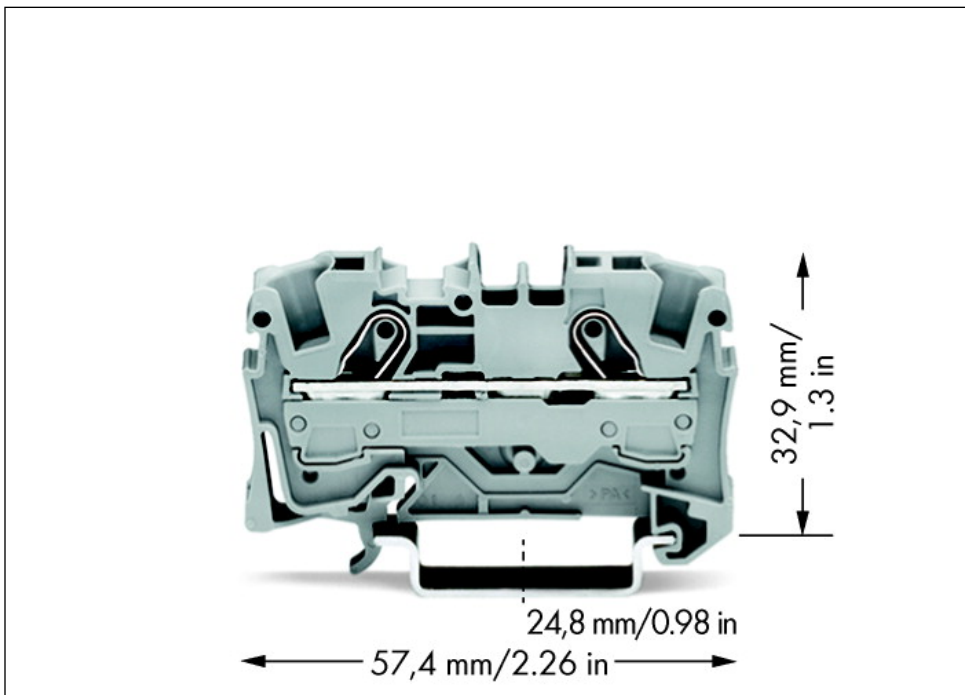
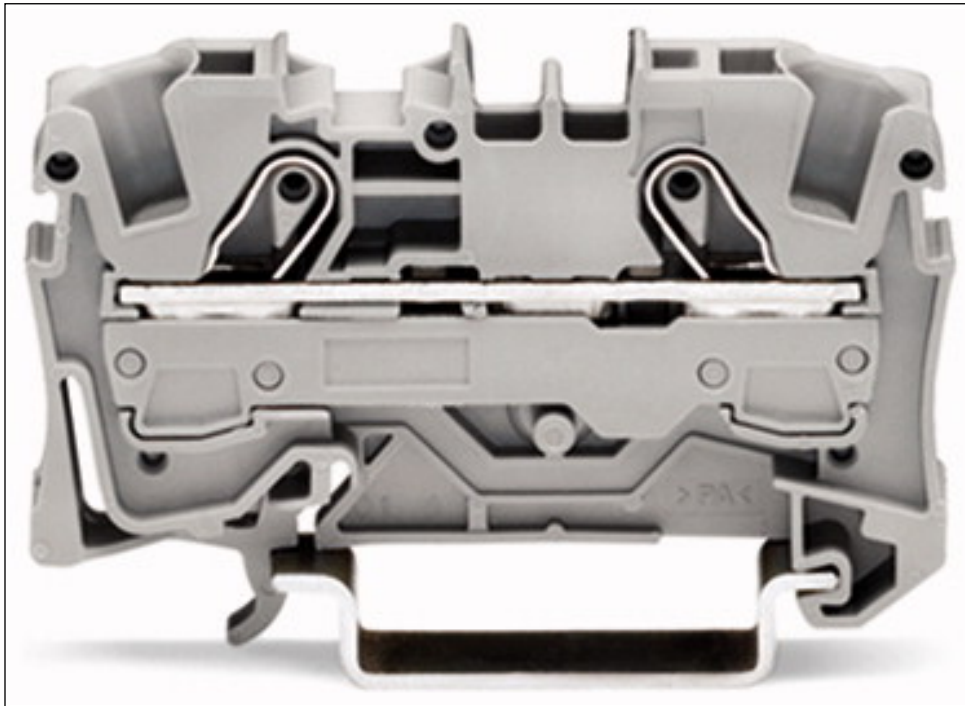

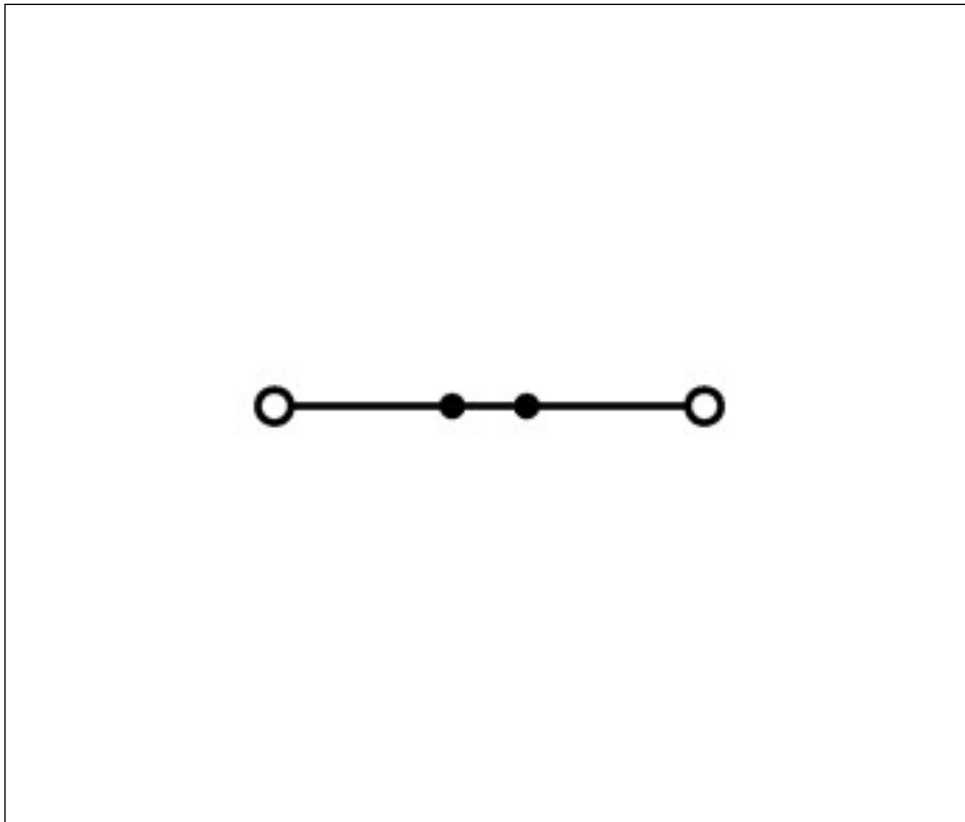

Address

WAGO Kontakttechnik GmbH & Co. KG

Hansastr. 27

32423 Minden

Telefon: 0571/887-0

Fax: 0571/887-169

<http://www.wago.com>

© WAGO Kontakttechnik GmbH & Co. KG

Technische Änderungen und Irrtümer vorbehalten.