

4-conductor through terminal block

Item No.: 280-621

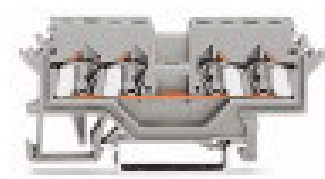

4-conductor through terminal block

Marking

RoHS ✓
Compliant

Business data

Supplier	WAGO
Item no.	280-621
GTIN / EAN	4044918391092
Content	1
Order amount	100
Customer item number	

Notes

Technical data

Miscellaneous

Total number of connection points	4
Total number of potentials	1
Color	gray
Ratings according to 1	IEC/EN 60947-7-1
Pollution degree (1)	3
Rated voltage EN (1) [V]	800 [V]
Rated surge voltage (1) [kV]	8 [kV]
Nominal current [A]	24 [A]
Connection technology (1)	CAGE CLAMP®
Solid sizes 1	0.08 ... 2.5 mm ² / 28 ... 12 AWG

Technical data	
<i>Fine-stranded wires 1</i>	<i>0.08 ... 2.5 mm² / 28 ... 12 AWG</i>
<i>Strip length 1</i>	<i>8 ... 9 mm / 0.31 ... 0.35 in</i>
<i>Note (conductor cross-section)</i>	<i>12 AWG: THHN, THWN</i>
<i>Type of wiring</i>	<i>Front-entry wiring</i>
<i>Design</i>	<i>horizontal</i>
<i>Marking level</i>	<i>Side marking</i>
<i>Insulating material</i>	<i>Polyamide 66 (PA 66)</i>
<i>Fire load [MJ]</i>	<i>0.135 [MJ]</i>
<i>Weight [g]</i>	<i>8.218 [g]</i>
<i>Width</i>	<i>5 mm / 0.197 in</i>
<i>Height from upper-edge of DIN-rail [mm]</i>	<i>28 [mm]</i>
<i>Height from upper-edge of DIN-rail</i>	<i>28 mm / 1.102 in</i>
<i>Length</i>	<i>73 mm / 2.874 in</i>
<i>Type of mounting</i>	<i>DIN 35 rail</i>

Images & drawings

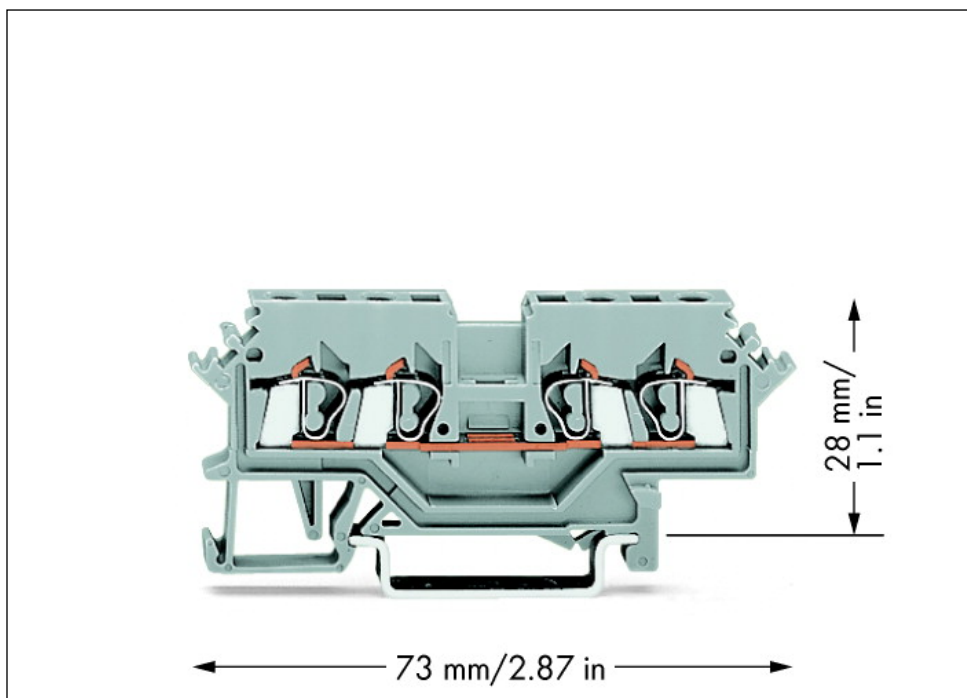
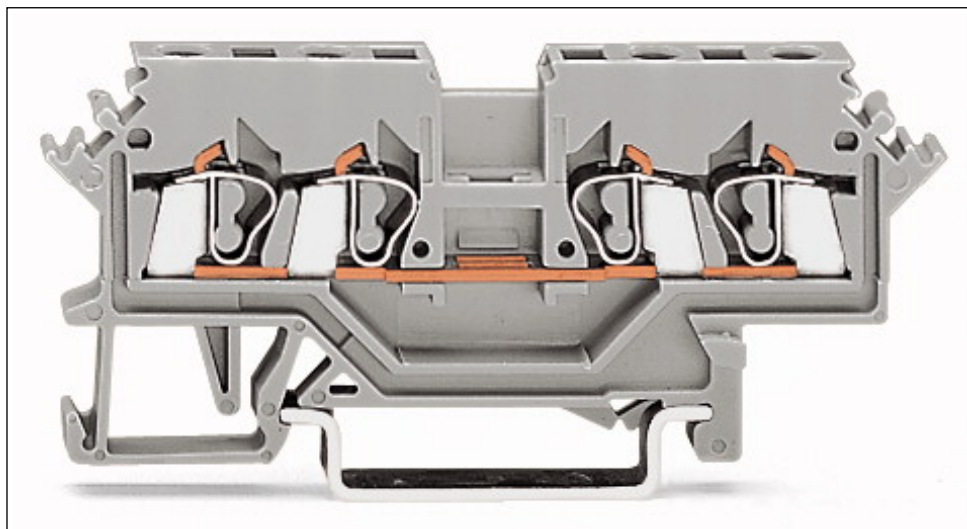

Address

WAGO Kontakttechnik GmbH & Co. KG

Hansastr. 27

32423 Minden

Telefon: 0571/887-0

Fax: 0571/887-169

<http://www.wago.com>

© WAGO Kontakttechnik GmbH & Co. KG

Technische Änderungen und Irrtümer vorbehalten.