

# SKM300GM12T4



## SEMITRANS® 3

### Fast IGBT4 Modules

#### SKM300GM12T4

#### Features

- IGBT4 = 4. generation fast trench IGBT (Infineon)
- CAL4 = Soft switching 4. generation CAL-diode
- Isolated copper baseplate using DBC technology (Direct Bonded Copper)
- Increased power cycling capability
- With integrated gate resistor
- For higher switching frequencies up to 20kHz
- UL recognized, file no. E63532

#### Typical Applications\*

- Matrix Inverter
- Bidirectional switch

#### Remarks

- Case temperature limited to  $T_c = 125^\circ\text{C}$  max.
- Recommended  $T_{op} = -40 \dots +150^\circ\text{C}$
- Product reliability results valid for  $T_j = 150^\circ\text{C}$

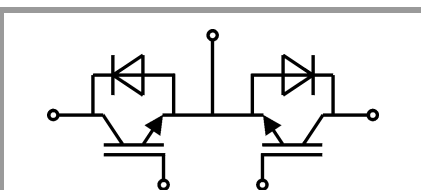

GM

#### Absolute Maximum Ratings

Symbol	Conditions	Values	Unit	
<b>IGBT</b>				
$V_{CES}$	$T_j = 25^\circ\text{C}$	1200	V	
$I_C$	$T_j = 175^\circ\text{C}$	$T_c = 25^\circ\text{C}$	422	A
		$T_c = 80^\circ\text{C}$	324	A
$I_{Cnom}$		300	A	
$I_{CRM}$	$I_{CRM} = 3 \times I_{Cnom}$	900	A	
$V_{GES}$		-20 ... 20	V	
$t_{psc}$	$V_{CC} = 800\text{ V}$ $V_{GE} \leq 15\text{ V}$ $V_{CES} \leq 1200\text{ V}$	$T_j = 150^\circ\text{C}$	10	$\mu\text{s}$
$T_j$		-40 ... 175	$^\circ\text{C}$	
<b>Inverse diode</b>				
$I_F$	$T_j = 175^\circ\text{C}$	$T_c = 25^\circ\text{C}$	353	A
		$T_c = 80^\circ\text{C}$	264	A
$I_{Fnom}$		300	A	
$I_{FRM}$	$I_{FRM} = 3 \times I_{Fnom}$	900	A	
$I_{FSM}$	$t_p = 10\text{ ms, sin } 180^\circ, T_j = 25^\circ\text{C}$	1548	A	
$T_j$		-40 ... 175	$^\circ\text{C}$	
<b>Module</b>				
$I_{t(RMS)}$	$T_{terminal} = 80^\circ\text{C}$	500	A	
$T_{stg}$		-40 ... 125	$^\circ\text{C}$	
$V_{isol}$	AC sinus 50 Hz, $t = 1\text{ min}$	4000	V	

#### Characteristics

Symbol	Conditions	min.	typ.	max.	Unit
<b>IGBT</b>					
$V_{CE(sat)}$	$I_C = 300\text{ A}$ $V_{GE} = 15\text{ V}$ chipelevel	$T_j = 25^\circ\text{C}$	1.85	2.10	V
		$T_j = 150^\circ\text{C}$	2.25	2.45	V
$V_{CE0}$	chipelevel	$T_j = 25^\circ\text{C}$	0.8	0.9	V
		$T_j = 150^\circ\text{C}$	0.7	0.8	V
$r_{CE}$	$V_{GE} = 15\text{ V}$ chipelevel	$T_j = 25^\circ\text{C}$	3.50	4.00	$\text{m}\Omega$
		$T_j = 150^\circ\text{C}$	5.17	5.50	$\text{m}\Omega$
$V_{GE(th)}$	$V_{GE} = V_{CE}, I_C = 12\text{ mA}$	5	5.8	6.5	V
$I_{CES}$	$V_{GE} = 0\text{ V}$ $V_{CE} = 1200\text{ V}$	$T_j = 25^\circ\text{C}$		4.0	$\text{mA}$
		$T_j = 150^\circ\text{C}$			$\text{mA}$
$C_{ies}$	$V_{CE} = 25\text{ V}$		17.6		nF
$C_{oes}$	$V_{GE} = 0\text{ V}$		1.16		nF
$C_{res}$			0.94		nF
$Q_G$	$V_{GE} = -8\text{ V} \dots +15\text{ V}$		1700		nC
$R_{Gint}$	$T_j = 25^\circ\text{C}$		2.5		$\Omega$
$t_{d(on)}$	$V_{CC} = 600\text{ V}$ $I_C = 300\text{ A}$	$T_j = 150^\circ\text{C}$	200		ns
$t_r$	$V_{GE} = \pm 15\text{ V}$	$T_j = 150^\circ\text{C}$	44		ns
$E_{on}$	$R_{Gon} = 1.5\ \Omega$	$T_j = 150^\circ\text{C}$	27		mJ
$t_{d(off)}$	$R_{Goff} = 1.5\ \Omega$	$T_j = 150^\circ\text{C}$	450		ns
$t_f$	$di/dt_{on} = 7500\text{ A}/\mu\text{s}$ $di/dt_{off} = 3350\text{ A}/\mu\text{s}$	$T_j = 150^\circ\text{C}$	90		ns
$E_{off}$		$T_j = 150^\circ\text{C}$	29		mJ
$R_{th(j-c)}$	per IGBT			0.11	K/W

# SKM300GM12T4



SEMITRANS® 3

## Fast IGBT4 Modules

### SKM300GM12T4

#### Features

- IGBT4 = 4. generation fast trench IGBT (Infineon)
- CAL4 = Soft switching 4. generation CAL-diode
- Isolated copper baseplate using DBC technology (Direct Bonded Copper)
- Increased power cycling capability
- With integrated gate resistor
- For higher switching frequencies up to 20kHz
- UL recognized, file no. E63532

#### Typical Applications\*

- Matrix Inverter
- Bidirectional switch

#### Remarks

- Case temperature limited to  $T_c = 125^\circ\text{C}$  max.
- Recommended  $T_{op} = -40 \dots +150^\circ\text{C}$
- Product reliability results valid for  $T_j = 150^\circ\text{C}$

Characteristics						
Symbol	Conditions		min.	typ.	max.	Unit
<b>Inverse diode</b>						
$V_F = V_{EC}$	$I_F = 300\text{ A}$ $V_{GE} = 0\text{ V}$ chipelevel	$T_j = 25^\circ\text{C}$		2.17	2.49	V
		$T_j = 150^\circ\text{C}$		2.11	2.42	V
$V_{F0}$	chipelevel	$T_j = 25^\circ\text{C}$		1.3	1.5	V
		$T_j = 150^\circ\text{C}$		0.9	1.1	V
$r_F$	chipelevel	$T_j = 25^\circ\text{C}$		2.9	3.3	m $\Omega$
		$T_j = 150^\circ\text{C}$		4.0	4.4	m $\Omega$
$I_{RRM}$	$I_F = 300\text{ A}$	$T_j = 150^\circ\text{C}$		345		A
$Q_{rr}$	$di/dt_{off} = 7300\text{ A}/\mu\text{s}$	$T_j = 150^\circ\text{C}$		54		$\mu\text{C}$
$E_{rr}$	$V_{GE} = \pm 15\text{ V}$ $V_{CC} = 600\text{ V}$	$T_j = 150^\circ\text{C}$		23		mJ
$R_{th(j-c)}$	per diode				0.17	K/W
<b>Module</b>						
$L_{CE}$				15	20	nH
$R_{CC'+EE'}$	terminal-chip	$T_c = 25^\circ\text{C}$		0.25		m $\Omega$
		$T_c = 125^\circ\text{C}$		0.5		m $\Omega$
$R_{th(c-s)}$	per module			0.02	0.038	K/W
$M_s$	to heat sink M6			3	5	Nm
$M_t$		to terminals M6		2.5	5	Nm
						Nm
$w$					325	g

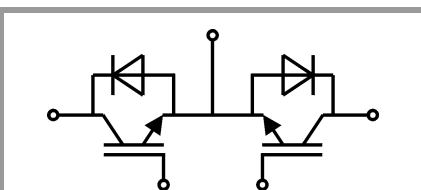

GM

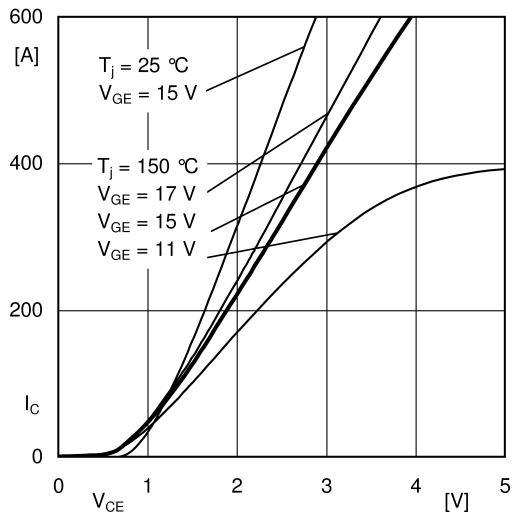

Fig. 1: Typ. output characteristic, inclusive  $R_{CC'+EE'}$

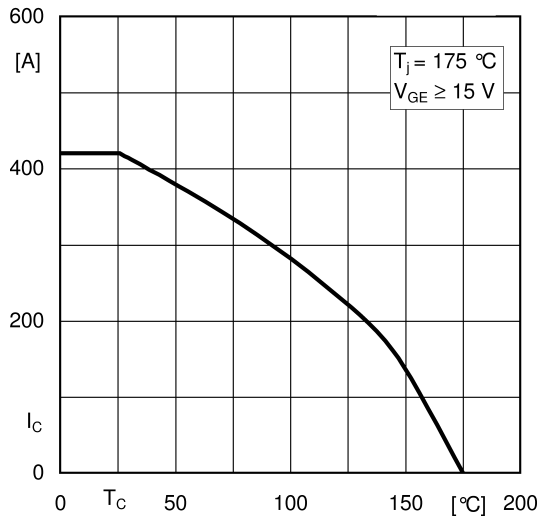

Fig. 2: Rated current vs. temperature  $I_C = f(T_C)$

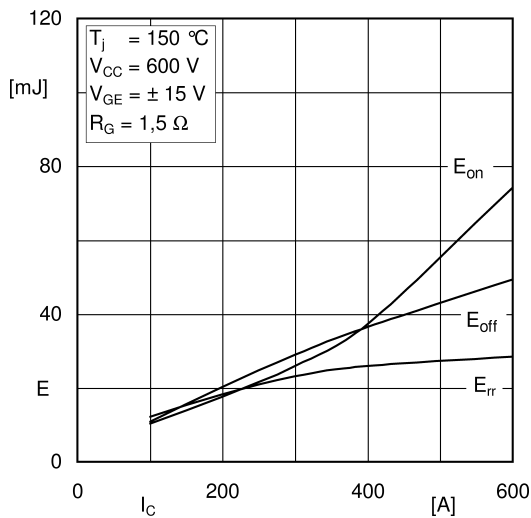

Fig. 3: Typ. turn-on /-off energy =  $f(I_C)$

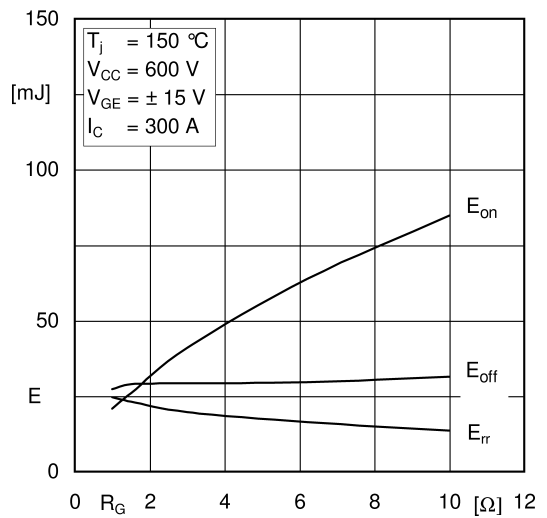

Fig. 4: Typ. turn-on /-off energy =  $f(R_G)$

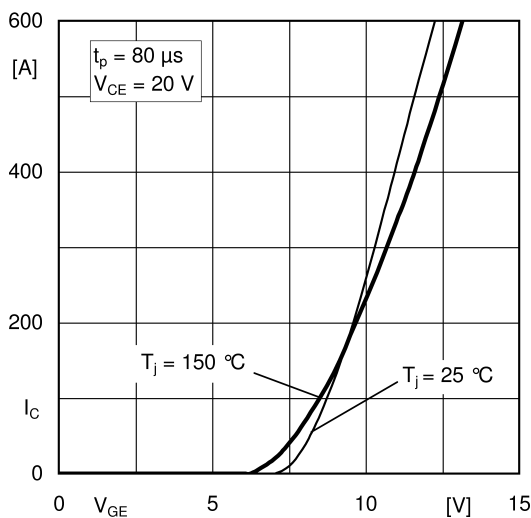

Fig. 5: Typ. transfer characteristic

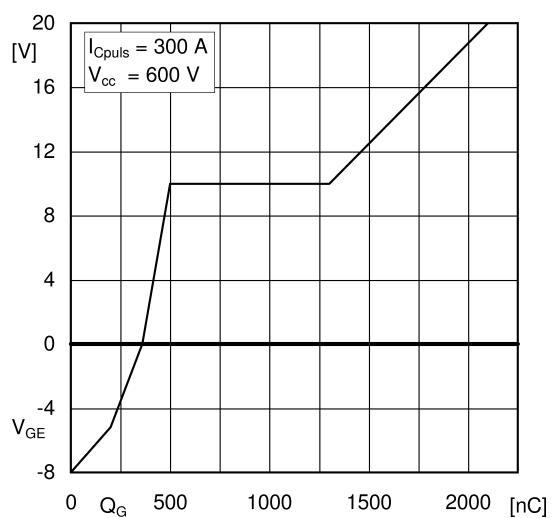

Fig. 6: Typ. gate charge characteristic

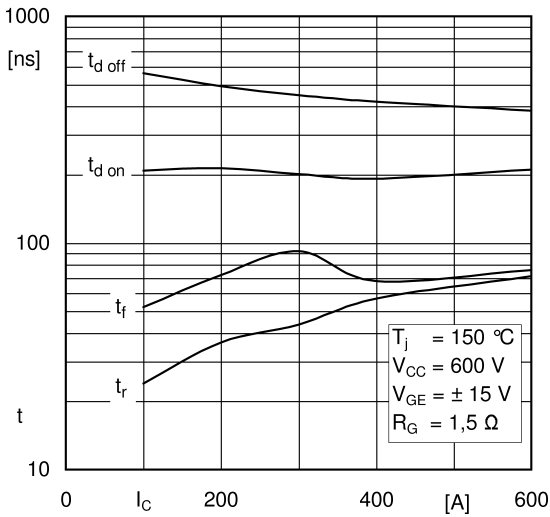

Fig. 7: Typ. switching times vs.  $I_C$

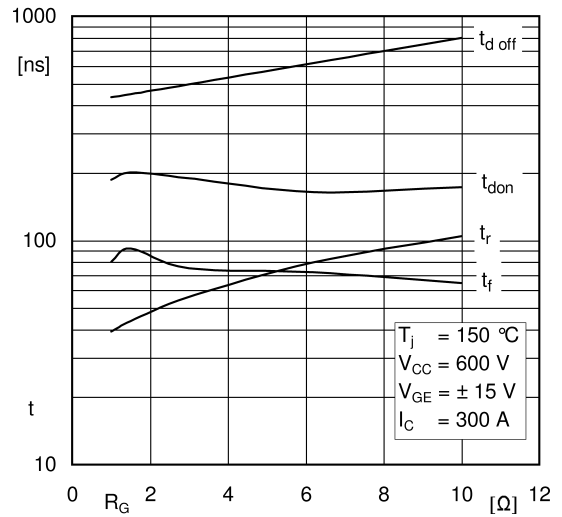

Fig. 8: Typ. switching times vs. gate resistor  $R_G$

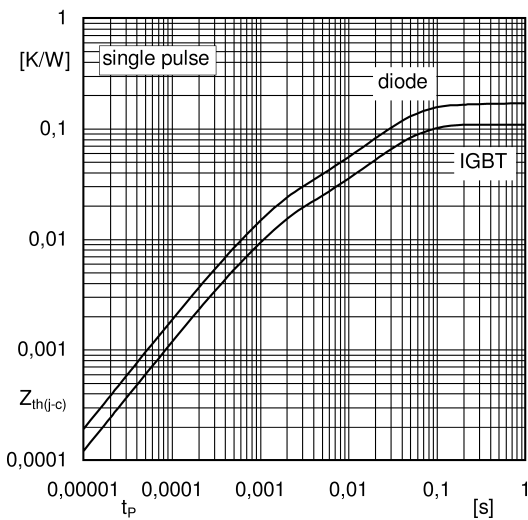

Fig. 9: Transient thermal impedance

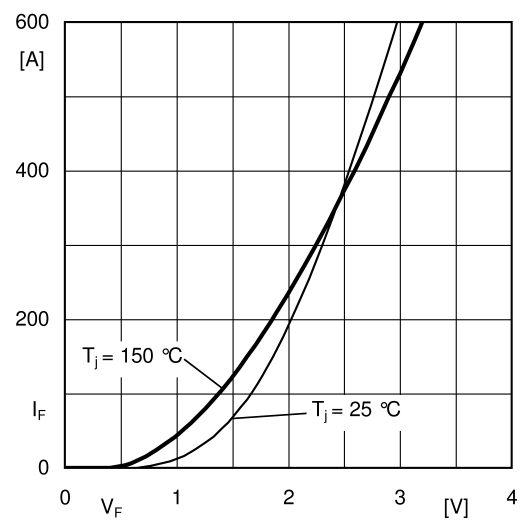

Fig. 10: Typ. CAL diode forward charact., incl.  $R_{CC+EE'}$

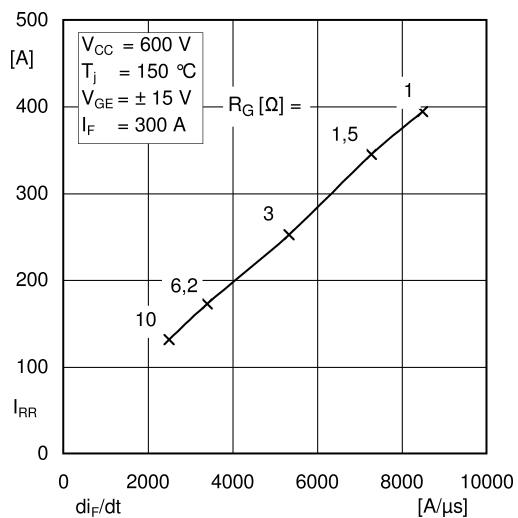

Fig. 11: CAL diode peak reverse recovery current

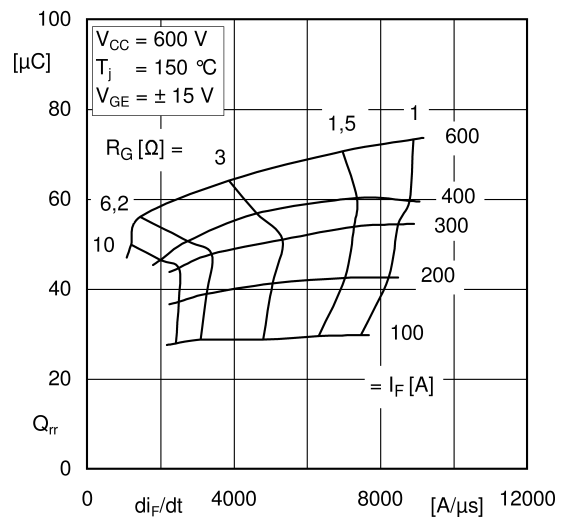
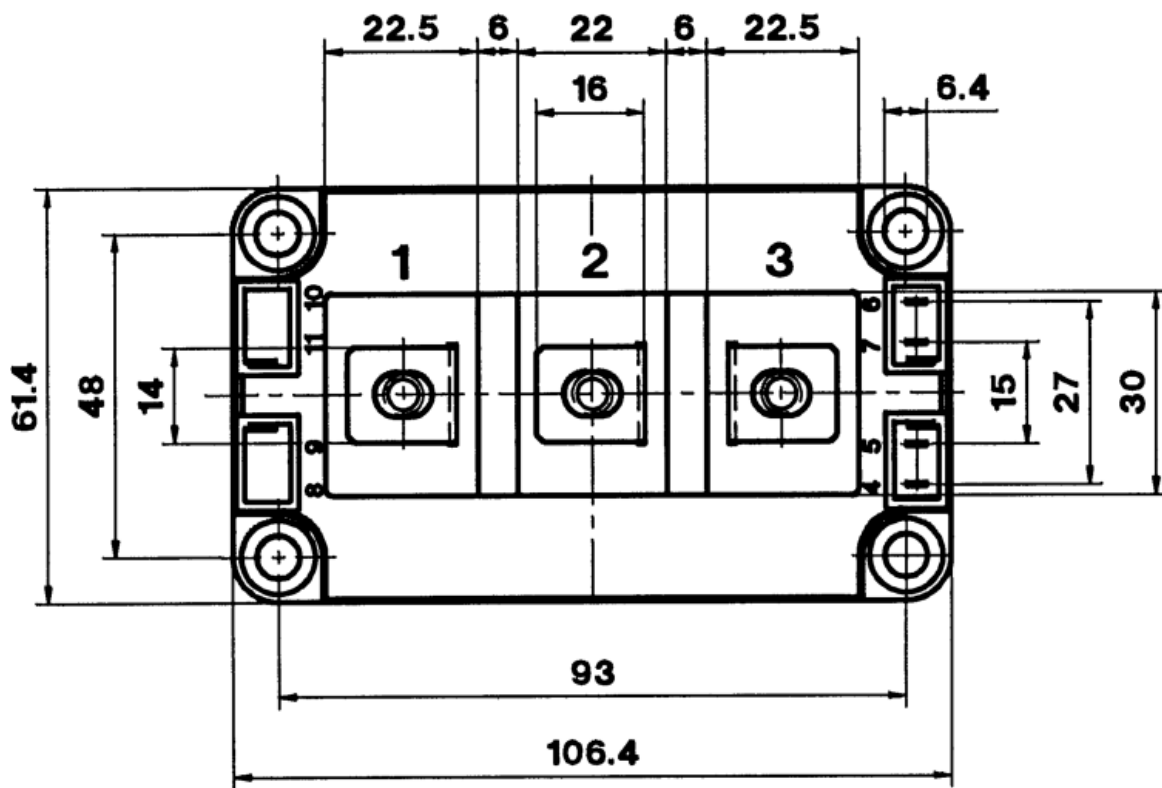
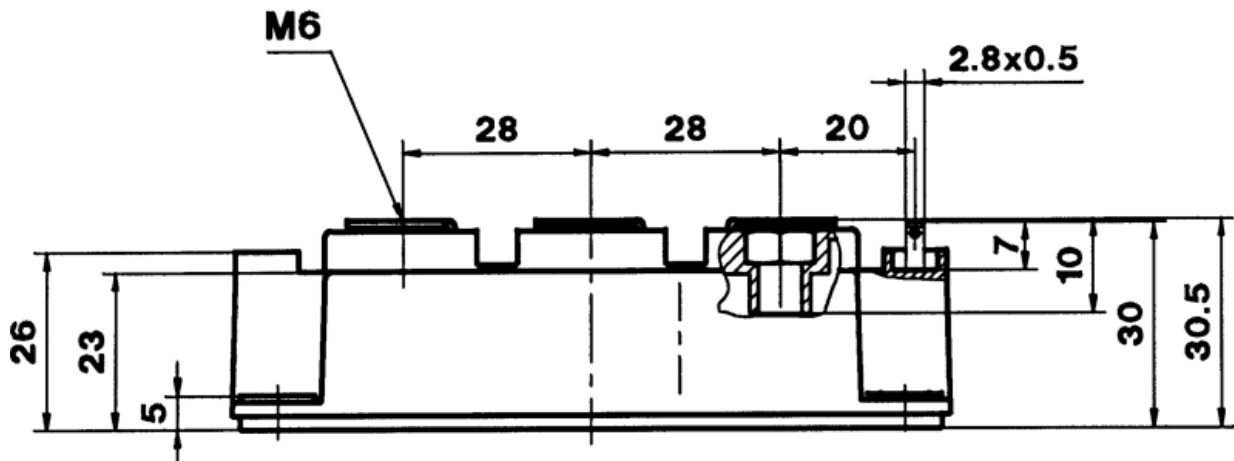
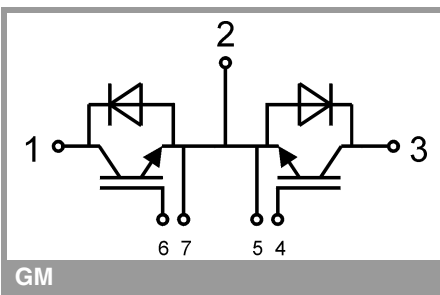

Fig. 12: Typ. CAL diode peak reverse recovery charge



SEMITRANS 3



GM

This is an electrostatic discharge sensitive device (ESDS), international standard IEC 60747-1, Chapter IX

\* The specifications of our components may not be considered as an assurance of component characteristics. Components have to be tested for the respective application. Adjustments may be necessary. The use of SEMIKRON products in life support appliances and systems is subject to prior specification and written approval by SEMIKRON. We therefore strongly recommend prior consultation of our staff.