

REV.	DESCRIPTION	DATE	APPROVED
G	Mounting Hole Tolerance Update	01/14/10	T. Y.
H	Updated General Specifications Note 1.	10/01/12	T. Y.
J	Updated For Concavity Face Clarification.	07/29/14	J. C.
K	Added Panel Thickness.	05/01/15	J. C.
L	Added Color Options, Sheet #2.	01/22/16	J. C.

Ø.152 [Ø3.9mm]
LIGHT PIPE

Ø.158 [Ø4.0mm]
REF.

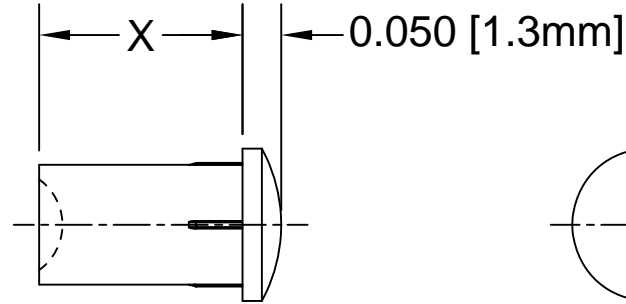
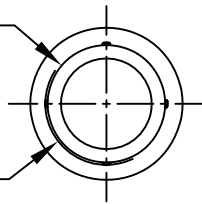

Ø.197 [Ø5.0mm]
FLANGE

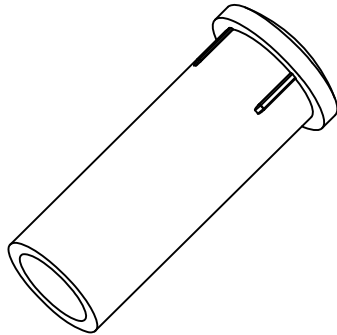
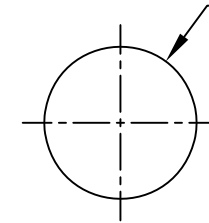

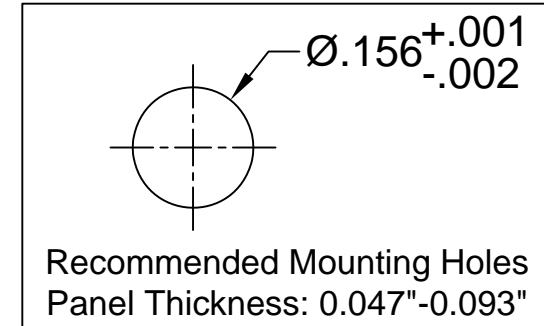

Part No.	X = Body Length
PLP5-2-125	0.125 (3.2mm)
PLP5-2-250	0.250 (6.4mm)
PLP5-2-350	0.350 (8.9mm)
PLP5-2-375	0.375 (9.5mm)
PLP5-2-500	0.500 (12.7mm)
PLP5-2-625	0.625 (15.9mm)
PLP5-2-750	0.750 (19.0mm)
PLP5-2-1000	1.000 (25.4mm)
PLP5-2-1250	1.250 (31.8mm)
PLP5-2-1500	1.500 (38.1mm)



2. MATERIAL: POLYCARBONATE, 94V-0, CLEAR.

1. GENERAL SPECIFICATIONS: BIVAR MOLDED COMPONENT SPECIFICATION BV00-E101 and BSMC-1001.

STANDARD TOLERANCE (UNLESS OTHERWISE SPECIFIED)		 4 THOMAS, IRVINE, CA. 92618 TEL: (949) 951-8808 FAX: (949) 951-3974		
DECIMALS	ANGULAR			
.X ± .1	X° ± 1°		TITLE: PRESS-FIT PANEL MOUNT LIGHT PIPE, LOW PROFILE ROUND, 5mm	
.XX ± .01			PART NO: PLP5-2-XXX	REVISION: L
.XXX ± .005			CAGE CODE : 32559	SHEET # 1 OF 2
DESIGNED: Michael Chen	DATE: 03/05/03	CHECKED: D. Green	DATE: 03/05/03	CAD GENERATED DOCUMENT. DO NOT MEASURE DRAWING.

OTHER AVAILABLE COLORS

* SEE TABLE FOR ORDERING INFORMATION

REV.	DESCRIPTION	DATE	APPROVED
	SEE SHEET #1		

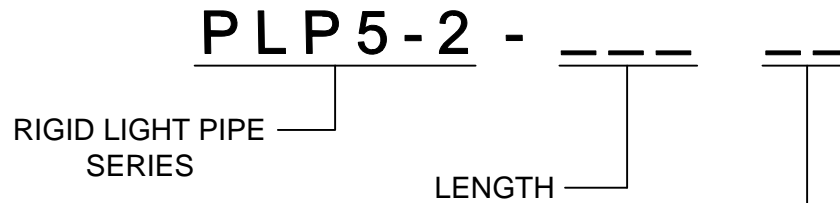

COLOR	Order Code
BLUE	BE
BLACK	BK
GREEN	GN
GRAY	GY
RED	RD
YELLOW	YW

NOTE: LEAVE ORDER CODE BLANK IF NO COLOR IS DESIRED.

3. PARTS ARE DYED TO COLOR UPON REQUEST.

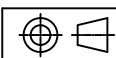
STANDARD TOLERANCE (UNLESS OTHERWISE SPECIFIED) DECIMALS ANGULAR		BIVAR [®] 4 THOMAS, IRVINE, CA. 92618 TEL: (949) 951-8808 FAX: (949) 951-3974	
			
DESIGNED: K. Aukshunas	DATE: 01/22/16	TITLE: PRESS-FIT PANEL MOUNT LIGHT PIPE, LOW PROFILE ROUND, 5mm	REVISION: L
CHECKED: J. Chiang	DATE: 01/22/16	PART NO: PLP5-2-XXX	CAGE CODE : 32559 SHEET # 2 OF 2
<small>CAD GENERATED DOCUMENT. DO NOT MEASURE DRAWING.</small>			