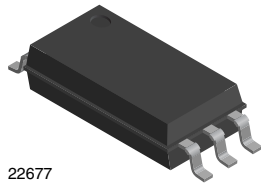
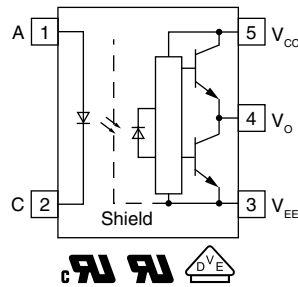


Low Profile, 2.5 A Output Current IGBT and MOSFET Driver



22677



DESCRIPTION

The VOL3120 consists of an infrared light emitting diode optically coupled to an integrated circuit with a power output stage. This optocoupler is ideally suited for driving power IGBTs and MOSFETs used in motor control and solar inverter applications. The high operating voltage range of the output stage provides the drive voltages required by gate controlled devices. The voltage and current supplied by this optocoupler makes it ideally suited for directly driving high power IGBTs with ratings up to 1000 V / 100 A. The low profile and small footprint of the VOL3120 makes it an ideal choice for applications where board space and component height are at a premium, while still offering a high degree of isolation performance.

AGENCY APPROVALS

The safety application model number covering all products in this datasheet is VOL3120. This model number should be used when consulting safety agency documents.

- UL 1577
- cUL
- CQC
- DIN EN 60747-5-5 (VDE 0884-5)

FEATURES

- Industrial temperature range: -40 °C to +100 °C
- 2.5 mm low profile package
- Rated for reinforced insulation
- 2.5 A minimum peak output current
- 48 kV/μs minimum common mode rejection (CMR) at $V_{CM} = 1500$ V
- $I_{CC} = 2.5$ mA maximum supply current
- Under voltage lock-out (UVLO) with hysteresis
- Wide operating V_{CC} range: 15 V to 32 V
- Floor life: unlimited, MSL 1, according to J-STD-020
- Material categorization: for definitions of compliance please see www.vishay.com/doc?99912



APPLICATIONS

- Domestic appliance motor drives
- Welding equipment
- Variable speed motor drives
- Induction stove top
- Solar inverters
- Switch mode power supplies (SMPS)
- Uninterruptible power supplies (UPS)

ORDERING INFORMATION		
<div style="display: flex; justify-content: space-around;"> <div style="border: 1px solid black; padding: 2px;">V</div> <div style="border: 1px solid black; padding: 2px;">O</div> <div style="border: 1px solid black; padding: 2px;">L</div> <div style="border: 1px solid black; padding: 2px;">3</div> <div style="border: 1px solid black; padding: 2px;">1</div> <div style="border: 1px solid black; padding: 2px;">2</div> <div style="border: 1px solid black; padding: 2px;">0</div> <div style="border: 1px solid black; padding: 2px;">-</div> <div style="border: 1px solid black; padding: 2px;">X</div> <div style="border: 1px solid black; padding: 2px;">0</div> <div style="border: 1px solid black; padding: 2px;">0</div> <div style="border: 1px solid black; padding: 2px;">#</div> <div style="border: 1px solid black; padding: 2px;">T</div> </div>	PART NUMBER	PACKAGE OPTION TAPE AND REEL
PACKAGE	UL, cUL, CQC	UL, cUL, CQC, VDE
LSOP-5	VOL3120T	VOL3120-X001T

ABSOLUTE MAXIMUM RATINGS ($T_{amb} = 25\text{ }^{\circ}\text{C}$, unless otherwise specified)				
PARAMETER	CONDITIONS	SYMBOL	VALUE	UNIT
INPUT				
Input forward current		I_F	25	mA
Peak transient input current	< 1 μs pulse width, 300 pps	$I_{F(TRAN)}$	1	A
Reverse input voltage		V_R	5	V
Output power dissipation		P_{diss}	40	mW
LED junction temperature		T_j	125	$^{\circ}\text{C}$
OUTPUT				
High peak output current ⁽¹⁾		$I_{OH(PEAK)}$	2.5	A
Low peak output current ⁽¹⁾		$I_{OL(PEAK)}$	2.5	A
Supply voltage		$(V_{CC} - V_{EE})$	0 to 35	V
Output voltage		$V_{O(PEAK)}$	0 to V_{CC}	V
Output power dissipation		P_{diss}	220	mW
Output junction temperature		T_j	125	$^{\circ}\text{C}$
OPTOCOUPLER				
Storage temperature range		T_{stg}	-55 to +150	$^{\circ}\text{C}$
Ambient operating temperature range		T_{amb}	-40 to +100	$^{\circ}\text{C}$
Total power dissipation		P_{tot}	260	mW
Lead solder temperature	For 10 s, 1.6 mm below seating plane	T_{sld}	260	$^{\circ}\text{C}$

Notes

- Stresses in excess of the absolute maximum ratings can cause permanent damage to the device. Functional operation of the device is not implied at these or any other conditions in excess of those given in the operational sections of this document. Exposure to absolute maximum ratings for extended periods of the time can adversely affect reliability.
- ⁽¹⁾ Maximum pulse width = 10 μs , maximum duty cycle = 0.2 %. This value is intended to allow for component tolerances for designs with I_{O} peak minimum = 2.5 A. See applications section for additional details on limiting I_{OH} peak.

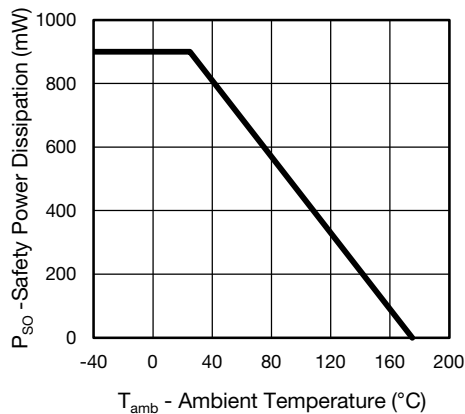


Fig. 1 - Safety Power Dissipation vs. Ambient Temperature

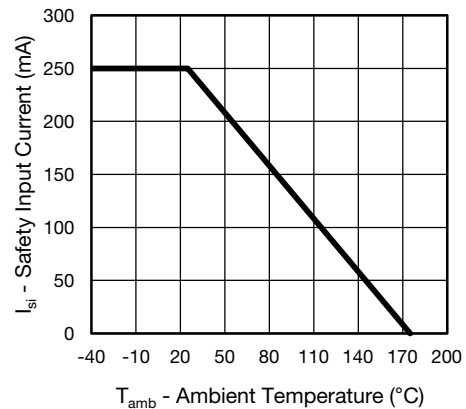


Fig. 2 - Safety Input Current vs. Ambient Temperature

RECOMMENDED OPERATING CONDITIONS				
PARAMETER	SYMBOL	MIN.	MAX.	UNIT
Power supply voltage	$V_{CC} - V_{EE}$	15	32	V
Input LED current (on)	I_F	10	-	mA
Input voltage (off)	$V_{F(OFF)}$	-3	0.8	V
Operating temperature	T_{amb}	-40	+100	°C

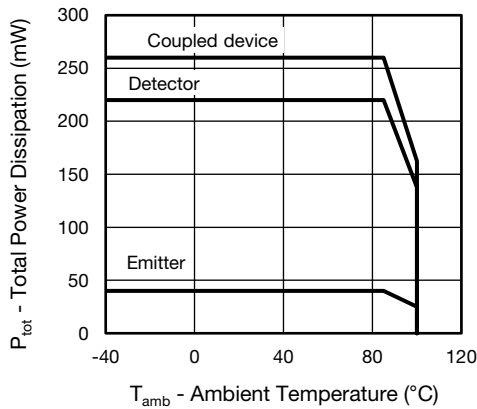


Fig. 3 - Power Dissipation vs. Ambient Temperature

ELECTRICAL CHARACTERISTICS						
PARAMETER	TEST CONDITION	SYMBOL	MIN.	TYP.	MAX.	UNIT
High level output current	$V_O = (V_{CC} - 4\text{ V})$	I_{OH}	0.5	-	-	A
	$V_O = (V_{CC} - 15\text{ V})$	I_{OH}	2.5	-	-	A
Low level output current	$V_O = (V_{EE} + 2.5\text{ V})$	I_{OL}	0.5	-	-	A
	$V_O = (V_{EE} + 15\text{ V})$	I_{OL}	2.5	-	-	A
High level output voltage	$I_O = -100\text{ mA}$	V_{OH}	$V_{CC} - 4$	-	-	V
Low level output voltage	$I_O = 100\text{ mA}$	V_{OL}	-	0.2	0.5	V
High level supply current	Output open, $I_F = 10\text{ mA}$ to 16 mA	I_{CCH}	-	-	2.5	mA
Low level supply current	Output open, $V_F = -3\text{ V}$ to $+0.8\text{ V}$	I_{CCL}	-	-	2.5	mA
Threshold input current low to high	$I_O = 0\text{ mA}$, $V_O > 5\text{ V}$	I_{FLH}	-	3.4	8	mA
Threshold input voltage high to low		V_{FHL}	0.8	-	-	V
Input forward voltage	$I_F = 10\text{ mA}$	V_F	1	1.36	1.6	V
Temperature coefficient of forward voltage	$I_F = 10\text{ mA}$	$\Delta V_F / \Delta T_{amb}$	-	-1.4	-	mV/°C
Input reverse breakdown voltage	$I_R = 10\text{ }\mu\text{A}$	V_{BR}	5	-	-	V
Input capacitance	$f = 1\text{ MHz}$, $V_F = 0\text{ V}$	C_{IN}	-	45	-	pF
UVLO threshold	$V_O \geq 5\text{ V}$, $I_F = 10\text{ mA}$	V_{UVLO+}	11	-	13.5	V
		V_{UVLO-}	9.5	-	12	V
UVLO hysteresis		$UVLO_{HYS}$	-	1.6	-	V
Capacitance (Input to Output)	$f = 1\text{ MHz}$, $V_F = 0\text{ V}$	C_{IO}	-	0.9	-	pF

Note

- Minimum and maximum values were tested over recommended operating conditions ($T_{amb} = -40\text{ }^\circ\text{C}$ to $+100\text{ }^\circ\text{C}$, $I_{F(ON)} = 10\text{ mA}$ to 16 mA , $V_{F(OFF)} = -3\text{ V}$ to 0.8 V , $V_{CC} = 15\text{ V}$ to 32 V , $V_{EE} = \text{ground}$) unless otherwise specified. Typical values are characteristics of the device and are the result of engineering evaluations. Typical values are for information only and are not part of the testing requirements. All typical values were measured at $T_{amb} = 25\text{ }^\circ\text{C}$ and with $V_{CC} - V_{EE} = 32\text{ V}$.

SWITCHING CHARACTERISTICS						
PARAMETER	TEST CONDITION	SYMBOL	MIN.	TYP.	MAX.	UNIT
Propagation delay time to logic low output	$R_g = 10 \Omega, C_g = 10 \text{ nF}, f = 10 \text{ kHz}, \text{duty cycle} = 50 \%$	t_{PHL}	0.1	0.25	0.5	μs
Propagation delay time to logic high output	$R_g = 10 \Omega, C_g = 10 \text{ nF}, f = 10 \text{ kHz}, \text{duty cycle} = 50 \%$	t_{PLH}	0.1	0.25	0.5	μs
Pulse width distortion	$R_g = 10 \Omega, C_g = 10 \text{ nF}, f = 10 \text{ kHz}, \text{duty cycle} = 50 \%$	PWD	-	-	0.3	μs
Rise time	$R_g = 10 \Omega, C_g = 10 \text{ nF}, f = 10 \text{ kHz}, \text{duty cycle} = 50 \%$	t_r	-	0.1	-	μs
Fall time	$R_g = 10 \Omega, C_g = 10 \text{ nF}, f = 10 \text{ kHz}, \text{duty cycle} = 50 \%$	t_f	-	0.1	-	μs
UVLO turn on delay	$V_O > 5 \text{ V}, I_F = 10 \text{ mA}$	$T_{\text{UVLO-ON}}$	-	0.8	-	μs
UVLO turn off delay	$V_O < 5 \text{ V}, I_F = 10 \text{ mA}$	$T_{\text{UVLO-OFF}}$	-	0.6	-	μs

Note

- Minimum and maximum values were tested over recommended operating conditions ($T_{\text{amb}} = -40 \text{ }^\circ\text{C}$ to $+100 \text{ }^\circ\text{C}$, $I_{\text{F(ON)}} = 10 \text{ mA}$ to 16 mA , $V_{\text{F(OFF)}} = -3 \text{ V}$ to 0.8 V , $V_{\text{CC}} = 15 \text{ V}$ to 32 V , $V_{\text{EE}} = \text{ground}$) unless otherwise specified. Typical values are characteristics of the device and are the result of engineering evaluations. Typical values are for information only and are not part of the testing requirements. All typical values were measured at $T_{\text{amb}} = 25 \text{ }^\circ\text{C}$ and with $V_{\text{CC}} - V_{\text{EE}} = 32 \text{ V}$.

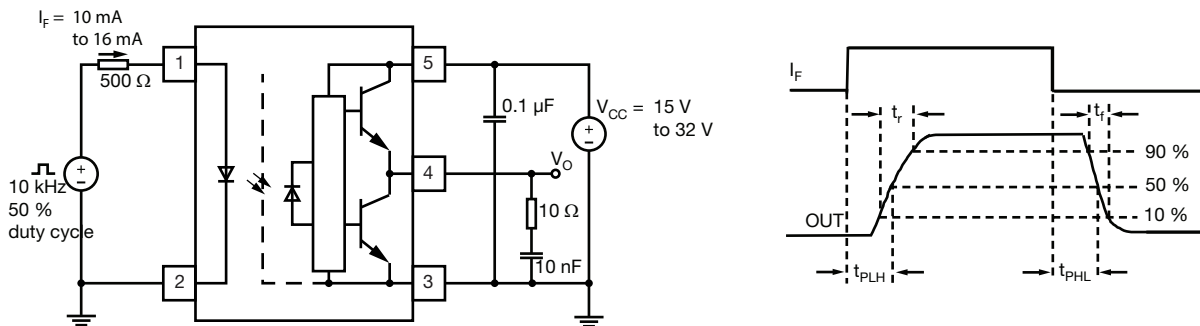


Fig. 4 - t_{PLH} , t_{PHL} , t_r and t_f Test Circuit and Waveforms

COMMON MODE TRANSIENT IMMUNITY						
PARAMETER	TEST CONDITION	SYMBOL	MIN.	TYP.	MAX.	UNIT
Common mode transient immunity at logic high output	$T_{\text{amb}} = 25 \text{ }^\circ\text{C}, I_F = 10 \text{ mA to } 16 \text{ mA}, V_{\text{CM}} = 1500 \text{ V}, V_{\text{CC}} = 32 \text{ V}$	$ \text{CM}_\text{H} $	48	-	-	$\text{kV}/\mu\text{s}$
Common mode transient immunity at logic low output	$T_{\text{amb}} = 25 \text{ }^\circ\text{C}, V_{\text{CM}} = 1500 \text{ V}, V_{\text{CC}} = 32 \text{ V}, V_F = 0 \text{ V}$	$ \text{CM}_\text{L} $	48	-	-	$\text{kV}/\mu\text{s}$

Note

- Minimum and maximum values were tested over recommended operating conditions ($T_{\text{amb}} = -40 \text{ }^\circ\text{C}$ to $+100 \text{ }^\circ\text{C}$, $I_{\text{F(ON)}} = 10 \text{ mA}$ to 16 mA , $V_{\text{F(OFF)}} = -3 \text{ V}$ to 0.8 V , $V_{\text{CC}} = 15 \text{ V}$ to 32 V , $V_{\text{EE}} = \text{ground}$) unless otherwise specified. Typical values are characteristics of the device and are the result of engineering evaluations. Typical values are for information only and are not part of the testing requirements. All typical values were measured at $T_{\text{amb}} = 25 \text{ }^\circ\text{C}$ and with $V_{\text{CC}} - V_{\text{EE}} = 32 \text{ V}$.

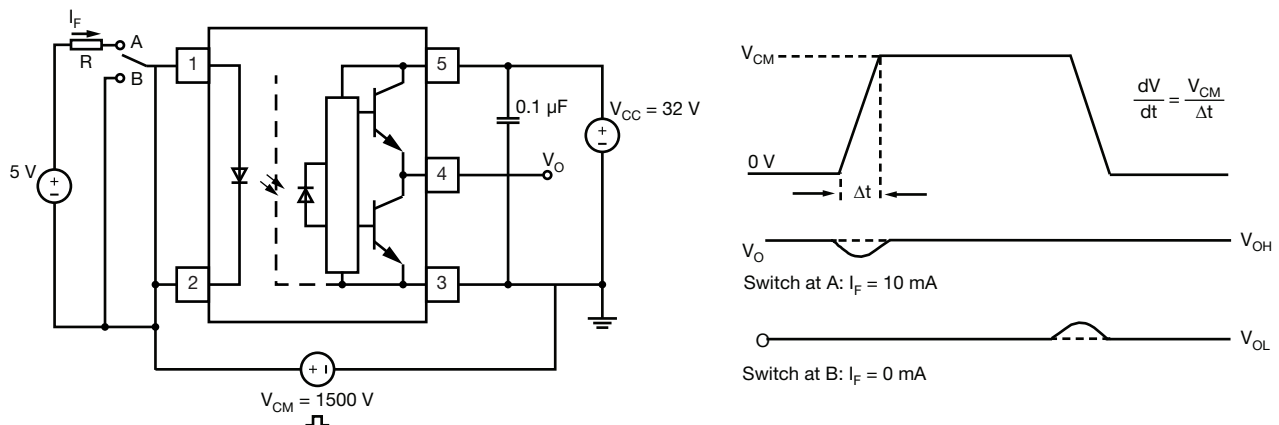


Fig. 5 - CMR Test Circuit and Waveforms

SAFETY AND INSULATION RATINGS				
PARAMETER	TEST CONDITION	SYMBOL	VALUE	UNIT
Climatic classification	According to IEC 68 part 1		40 / 100 / 21	
Comparative tracking index		CTI	175	
Maximum rated withstanding isolation voltage	t = 1 min	V _{ISO}	5300	V _{RMS}
Maximum transient isolation voltage		V _{IOTM}	8000	V
Maximum repetitive peak isolation voltage		V _{IORM}	1050	V
Isolation resistance	T _{amb} = 25 °C, V _{DC} = 500 V	R _{IO}	≥ 10 ¹²	Ω
	T _{amb} = 100 °C, V _{DC} = 500 V	R _{IO}	≥ 10 ¹¹	Ω
Output safety power		P _{SO}	900	mW
Input safety current		I _{SI}	250	mA
Safety temperature		T _S	175	°C
Creepage distance			≥ 8	mm
Clearance distance			≥ 8	mm
Insulation thickness		DTI	≥ 0.4	mm
Input to output test voltage, method B	V _{IORM} × 1.875 = V _{PR} , 100 % production test with t _M = 1 s, partial discharge < 5 pC	V _{PR}	1969	V _{peak}
Input to output test voltage, method A	V _{IORM} × 1.6 = V _{PR} , 100 % production test with t _M = 10 s, partial discharge < 5 pC	V _{PR}	1680	V _{peak}
Environment (pollution degree in accordance to DIN VDE 0109)			2	

Note

- As per IEC 60747-5-5, § 7.4.3.8.2, this optocoupler is suitable for “safe electrical insulation” only within the safety ratings. Compliance with the safety ratings shall be ensured by means of protective circuits.

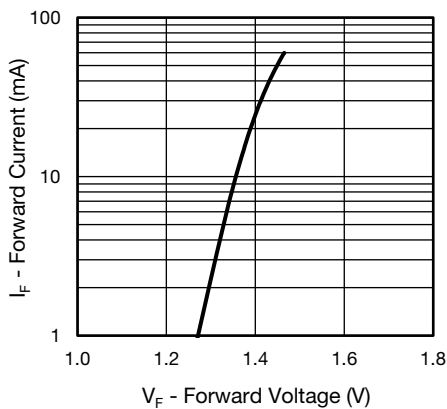
TYPICAL CHARACTERISTICS (T_{amb} = 25 °C, unless otherwise specified)


Fig. 6 - Forward Current vs. Forward Voltage

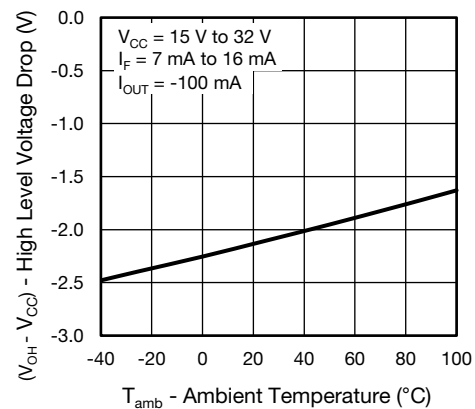


Fig. 7 - High Level Voltage Drop vs. Ambient Temperature

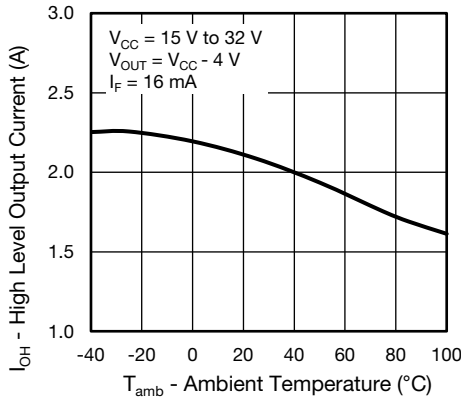


Fig. 8 - High Level Output Current vs. Ambient Temperature

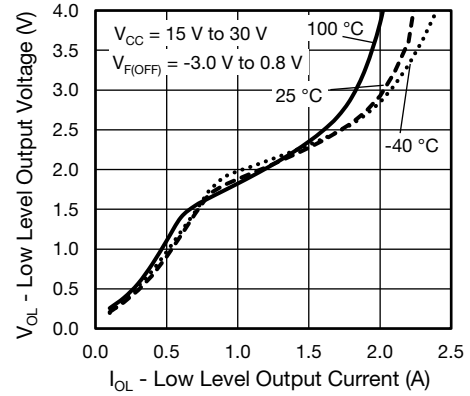


Fig. 11 - Low Level Output Voltage vs. Low Level Output Current

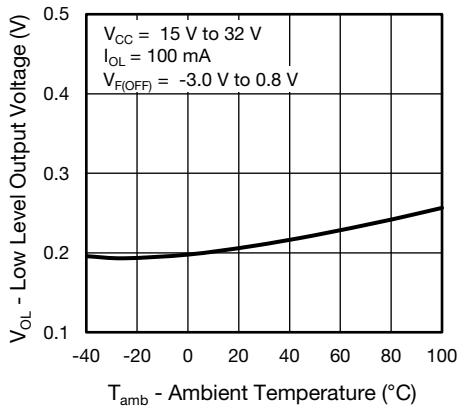


Fig. 9 - Low Level Output Voltage vs. Ambient Temperature

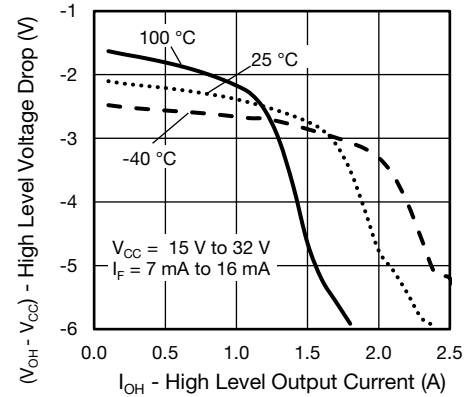


Fig. 12 - High Level Voltage Drop vs. High Level Output Current

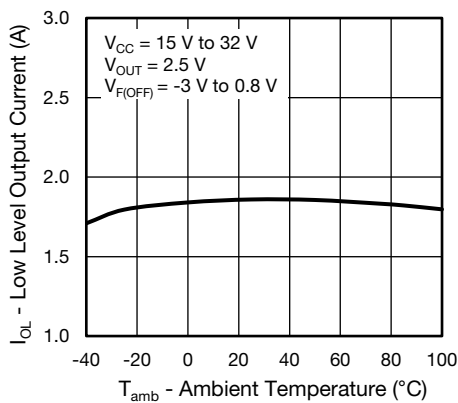


Fig. 10 - Low Level Output Current vs. Ambient Temperature

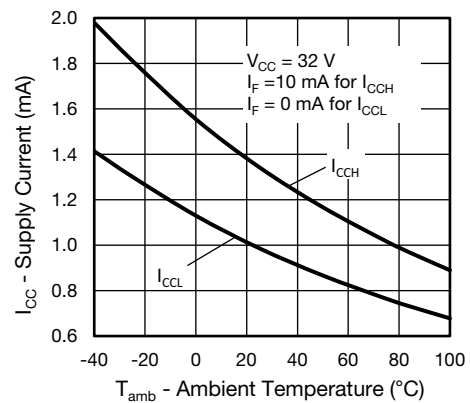


Fig. 13 - Supply Current vs. Ambient Temperature

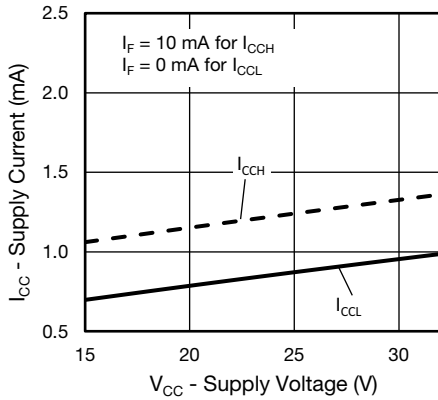


Fig. 14 - Supply Current vs. Supply Voltage

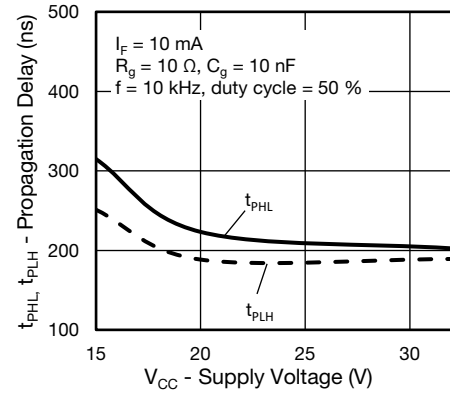


Fig. 17 - Propagation Delay vs. Supply Voltage

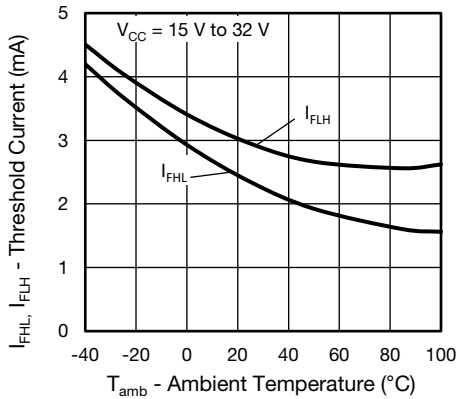


Fig. 15 - Threshold Current vs. Ambient Temperature

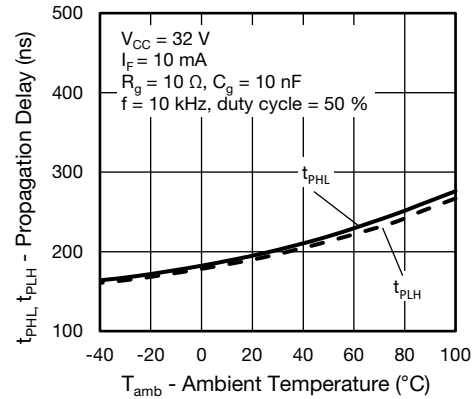


Fig. 18 - Propagation Delay vs. Ambient Temperature

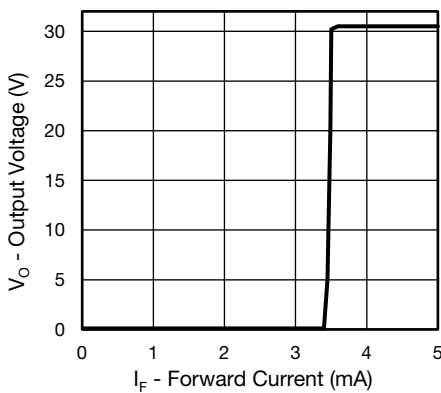


Fig. 16 - Output Voltage vs. Forward Current

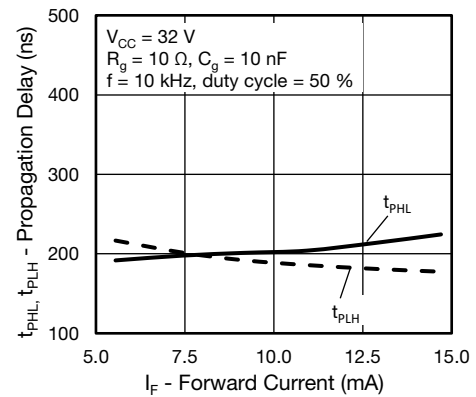


Fig. 19 - Propagation Delay vs. Forward Current

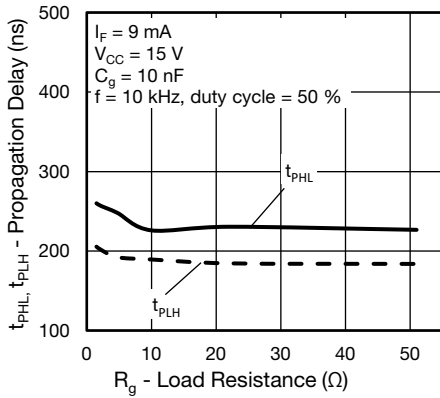


Fig. 20 - Propagation Delay vs. Load Resistance

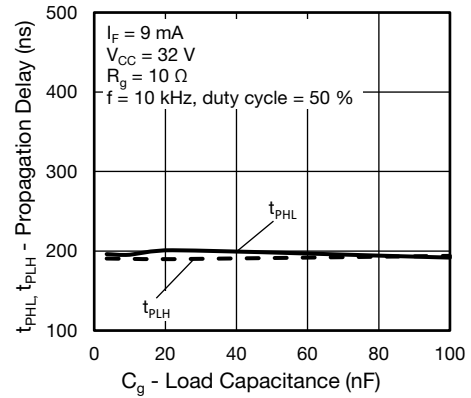


Fig. 21 - Propagation Delay vs. Load Capacitance

PACKAGE DIMENSIONS (in millimeters)

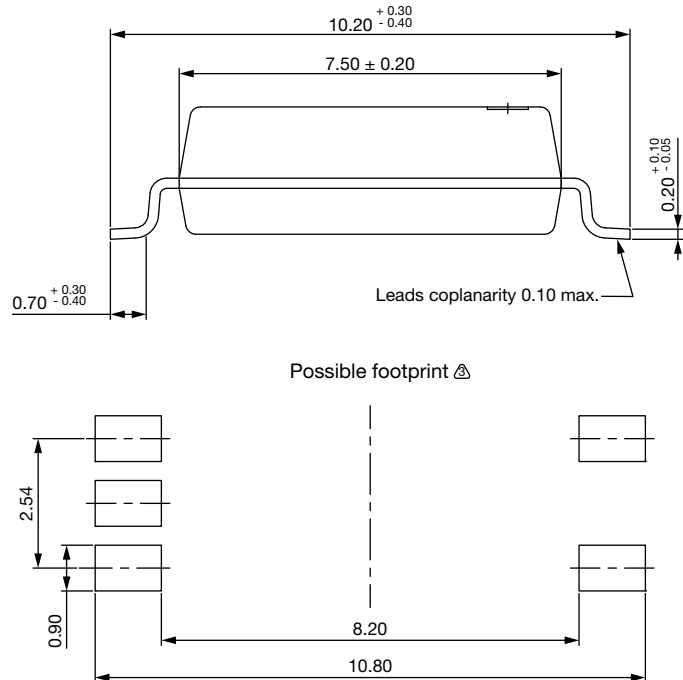
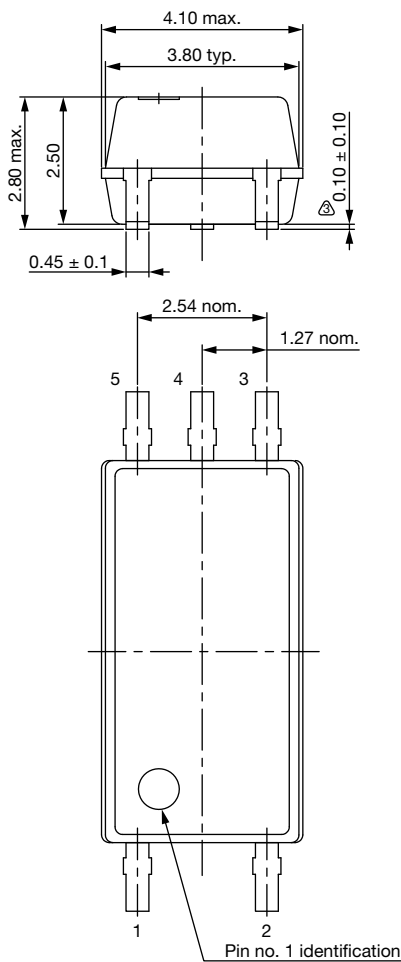


Fig. 22 - Package Drawing

PACKAGE MARKING

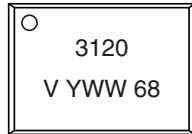


Fig. 23 - VOL3120T

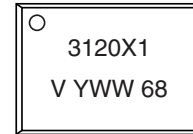


Fig. 24 - VOL3120-X001T

PACKING INFORMATION (tape and reel)

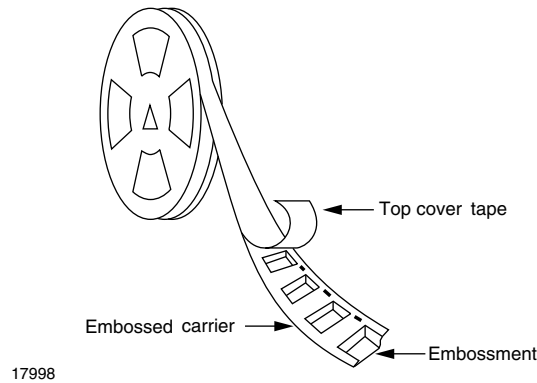
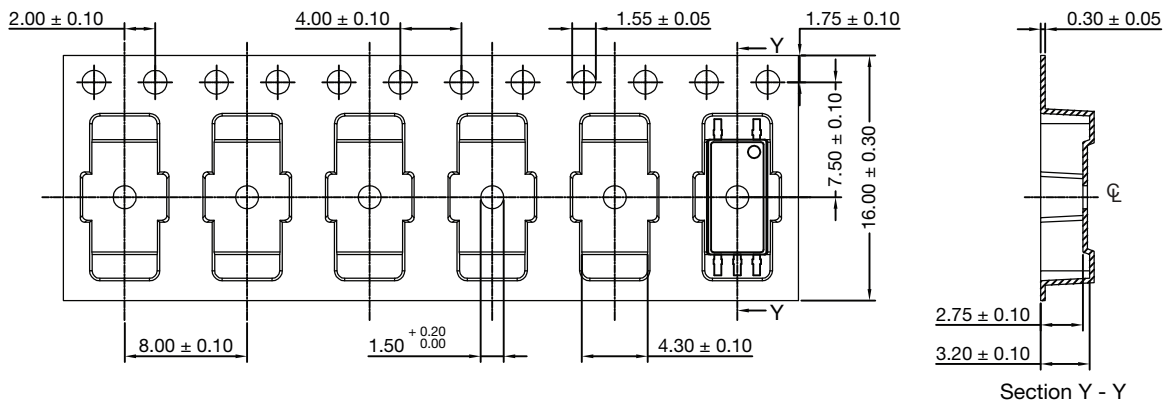


Fig. 25 - Tape and Reel Shipping Medium

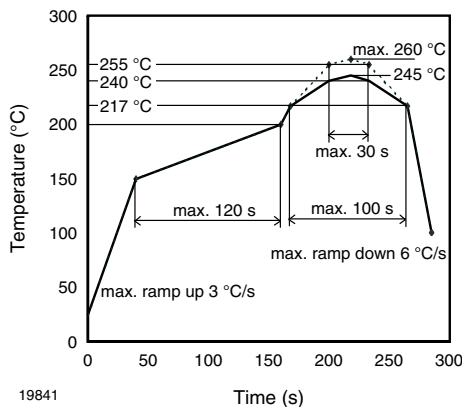


Note:

- 1. Cumulative tolerance of 10 spocket holes is ± 0.20 .

Fig. 26 - Tape and Reel Packing (2000 pieces on reel)

SOLDER PROFILE



19841

Fig. 27 - Lead (Pb)-free Reflow Solder Profile According to J-STD-020

HANDLING AND STORAGE CONDITIONS

ESD level: HBM class 2

Floor life: unlimited

Conditions: $T_{amb} < 30\text{ °C}$, $RH < 85\%$

Moisture sensitivity level 1, according to J-STD-020



Disclaimer

ALL PRODUCT, PRODUCT SPECIFICATIONS AND DATA ARE SUBJECT TO CHANGE WITHOUT NOTICE TO IMPROVE RELIABILITY, FUNCTION OR DESIGN OR OTHERWISE.

Vishay Intertechnology, Inc., its affiliates, agents, and employees, and all persons acting on its or their behalf (collectively, "Vishay"), disclaim any and all liability for any errors, inaccuracies or incompleteness contained in any datasheet or in any other disclosure relating to any product.

Vishay makes no warranty, representation or guarantee regarding the suitability of the products for any particular purpose or the continuing production of any product. To the maximum extent permitted by applicable law, Vishay disclaims (i) any and all liability arising out of the application or use of any product, (ii) any and all liability, including without limitation special, consequential or incidental damages, and (iii) any and all implied warranties, including warranties of fitness for particular purpose, non-infringement and merchantability.

Statements regarding the suitability of products for certain types of applications are based on Vishay's knowledge of typical requirements that are often placed on Vishay products in generic applications. Such statements are not binding statements about the suitability of products for a particular application. It is the customer's responsibility to validate that a particular product with the properties described in the product specification is suitable for use in a particular application. Parameters provided in datasheets and / or specifications may vary in different applications and performance may vary over time. All operating parameters, including typical parameters, must be validated for each customer application by the customer's technical experts. Product specifications do not expand or otherwise modify Vishay's terms and conditions of purchase, including but not limited to the warranty expressed therein.

Except as expressly indicated in writing, Vishay products are not designed for use in medical, life-saving, or life-sustaining applications or for any other application in which the failure of the Vishay product could result in personal injury or death. Customers using or selling Vishay products not expressly indicated for use in such applications do so at their own risk. Please contact authorized Vishay personnel to obtain written terms and conditions regarding products designed for such applications.

No license, express or implied, by estoppel or otherwise, to any intellectual property rights is granted by this document or by any conduct of Vishay. Product names and markings noted herein may be trademarks of their respective owners.