

## High Performance and Computer Grade Point-of-Use Surge Protectors

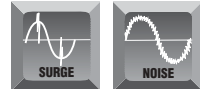

The Sentrex High Performance Surge Protector Series and the Perma Power Computer Grade Surge Protector Series include a wide range of solutions for point-of-use surge protection applications. By dissipating and diverting excess voltage, Sentrex and Perma Power surge protection devices keep your critical systems functioning properly.

Electrical surges are present in every AC power system. They can penetrate a facility via AC, telephone, and communication lines, or on any other wires that enter a building. Surges and noise are also generated inside a building by fluorescent lighting, office machines, electric motors and HVAC equipment. Surges can strike once a month or hundreds of times a day, destroying data and damaging valuable hardware.

Sentrex High Performance Cord-Ended Surge Protectors provide maximum protection for advanced electronic equipment. Perma Power Computer Grade units provide excellent point-of-use surge protection for personal computers, fax machines, home electronics and appliances.



M6BZ



SRD10N





### Features & Benefits

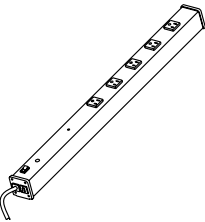

- **All lines are protected.** Units provide surge and noise protection on all three modes (L-N, L-G, and N-G). Units also have thermal protection on all three lines.
- **400V UL1449 clamping level.** Outstanding protection against harmful surges.
- **EMI/RFI noise reduction.** Protects against data disruption due to electromagnetic or radio frequency interference.
- **Rugged construction.** Durable 2" x 1 3/4" [44mm x 51mm] aluminum housing. Some Perma Power units are available with an impact resistant plastic housing.
- **Aesthetically pleasing.** Putty white finish and putty white cord blend with any decor. M5S and M5BZ feature putty white housing with black outlets and a black cord.
- **Cord properly rated to load requirements.** 15A units have a 14/3 SJT cord and a NEMA 5-15P plug. 20A units have a 12/3 SJT cord and a NEMA 5-20P plug.
- **Lighted switch.** Most units have a lighted on/off switch to control power to the unit.
- **Protection indication.** All units have protection indication light(s) to show the status of the unit.
- **Resettable circuit breaker.** Provides overload protection.
- **Up to lifetime product warranty.** With connected equipment warranty up to \$30,000.
- **UL and cUL Listed.** All units are UL Listed and meet UL1449 2nd Edition Standards for Transient Voltage Surge Suppressors dated August 15, 1996 including requirements effective February 9, 2007. All units are cUL Listed or CSA Certified except as noted.

## Sentrex High Performance Specifications

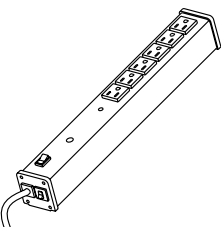
<b>Surge Protection Circuitry</b>	Patented 4 element, 4 stage hybrid circuit
<b>UL1449 Clamping Level</b>	400 Volts (L-N 330 Volts)
<b>Maximum Surge Current</b>	56,000 Amps (32,000A L-N, 12,000A L-G, 12,000A N-G)
<b>Noise Reduction</b>	50 dB
<b>Response Time</b>	Less than 1 nanosecond
<b>Product Warranty</b>	Lifetime
<b>Connected Equipment Warranty</b>	\$30,000

## Sentrex High Performance Surge Protectors

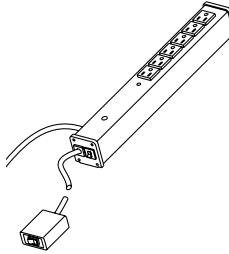
Catalog No./Item	Description/Specifications
<p><b>M5S</b></p> 	<p><b>High Performance Surge Protector</b> – Five outlets, lighted switch. Receptacles rotated 90° and spaced to accommodate transformers. 6' [1.8m] cord. Length 24" [610mm].</p> 
<p><b>M6S/M6S-15</b></p> 	<p><b>High Performance Surge Protector</b> – Six outlets, lighted switch. 6' [1.8m] or 15' [4.6m] cord. Length 15 1/4" [387mm].</p> 

Catalog No./Item	Description/Specifications
<p><b>M6SR/M6SR-15</b></p> 	<p><b>High Performance Surge Protector</b> – Six outlets, remote switch. 6' [1.8m] or 15' [4.6m] cord. Length 15 1/4" [387mm].</p> 

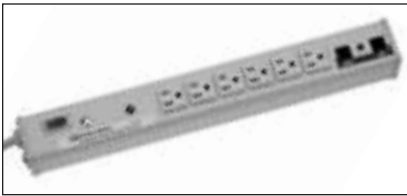

**M6BZM**

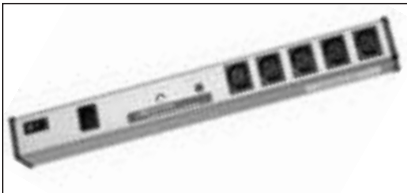

**M5BZIEC**



**M6SR**



**PR609N**

## Perma Power Computer Grade Specifications

<b>Surge Protection Circuitry</b>	Single Stage
<b>UL1449 Clamping Level</b>	400 Volts
<b>Maximum Surge Current</b>	36,000 Amps (12,000A L-N, 12,000A L-G, 12,000A N-G)
<b>Noise Reduction</b>	35 dB
<b>Response Time</b>	Less than 1 nanosecond
<b>Product Warranty</b>	5-Year
<b>Connected Equipment Warranty</b>	\$10,000

\* Except where noted

## Perma Power Computer Grade Surge Protectors

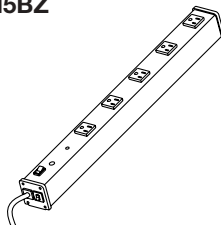
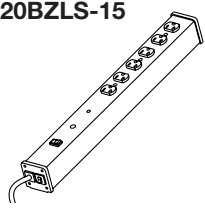
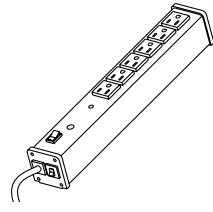
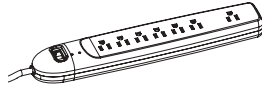
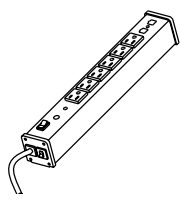
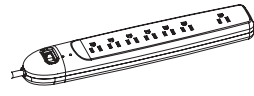
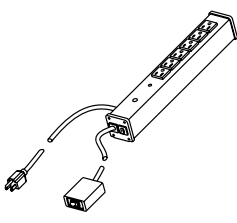
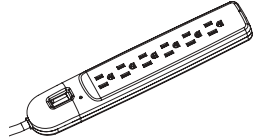
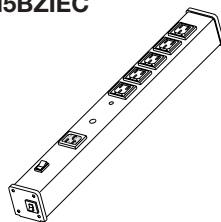
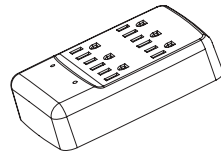
Catalog No./Item	Description/Specifications	Catalog No./Item	Description/Specifications
<b>M5BZ</b> 	<b>Computer Grade Surge Protector</b> – Five outlets, lighted switch. Receptacles rotated 90° and spaced to accommodate transformers. 6' [1.8m] cord. Length 21" [533mm].	<b>M620BZLS/ M620BZLS-15</b> 	<b>Computer Grade Surge Protector</b> – Six 20A outlets, lighted switch. 6' [1.8m] or 15' [4.6m] cord. Length 18" [457mm].
<b>M6BZ/M6BZ-15</b> 	<b>Computer Grade Surge Protector</b> – Six outlets, lighted switch. 6' [1.8m] or 15' [4.6m] cord. Length 13 1/4" [337mm].	<b>SR10N</b> 	<b>Computer Grade Surge Protector</b> – Seven outlets, lighted switch. Plastic Housing. 6' [1.8m] cord. 13 1/4" x 2 1/2" x 1 9/16" [337mm x 64mm x 40mm].
<b>M6BZM/M6BZM-15</b> 	<b>Computer Grade Surge Protector</b> – Six outlets, lighted switch. Phone/Fax protection. 6' [1.8m] or 15' [4.6m] cord. Length 16" [407mm].	<b>SRD10N</b> 	<b>Computer Grade Surge Protector</b> – Seven outlets, lighted switch. Plastic Housing. 6' [1.8m] cord. Phone/Fax protection. 13 1/4" x 2 1/2" x 1 9/16" [337mm x 64mm x 40mm].
<b>M6BZR/M6BZR-15</b> 	<b>Computer Grade Surge Protector</b> – Six outlets, remote switch. 6' [1.8m] or 15' [4.6m] cord. Length 13 1/4" [337mm].	<b>PR610N</b> 	<b>Computer Grade Surge Protector</b> – Six outlets, lighted switch. Plastic Housing. 6' [1.8m] cord. Maximum surge current 6500 Amps. 11 3/4" x 2 1/4" x 1 1/2" [298mm x 57mm x 38mm].
<b>M5BZIEC</b> 	<b>Computer Grade Surge Protector</b> – Five 250V IEC outlets, lighted switch. Gray finish, 10A single pole circuit breaker. Power cord not included. Length 18" [457mm]. UL 1950 Information Technology Listed. Not listed to UL1449.	<b>PR609N</b> 	<b>Computer Grade Surge Protector</b> – Six outlet wall plug. Maximum surge current 6500 Amps. Plastic Housing. 5" x 3 3/8" x 1 3/4" [127mm x 86mm x 44mm].
<b>NOTE:</b> No connected equipment warranty on M5BZIEC.			

**Questions? Call Technical Support today at 1-800-SENTREX.**

**WIREMOLD**



**Wiremold / Legrand**

*U.S. and International:*

60 Woodlawn Street • West Hartford, CT 06110

1-800-621-0049 • FAX 860-232-2062 • Outside U.S. 860-233-6251

*Canada:*

570 Applewood Crescent • Vaughan, Ontario L4K 4B4

1-800-723-5175 • FAX 905-738-9721

