

PLEASE CHECK WWW.MOLEX.COM FOR LATEST PART INFORMATION

Part Number: [5013301200](#)
Status: **Active**
Overview: Pico-Clasp™ Wire-to-Board Connectors
Description: 1.00mm Pitch Pico-Clasp™ Wire-to-Board Female Housing, Single Row, with Positive Lock, 12 Circuits

Documents:

3D Model	Product Specification PS-504449-001 (PDF)
Drawing (PDF)	Packaging Specification SPK-501330-001 (PDF)
Product Specification PS-501331-001 (PDF)	RoHS Certificate of Compliance (PDF)
Product Specification PS-501568-001 (PDF)	

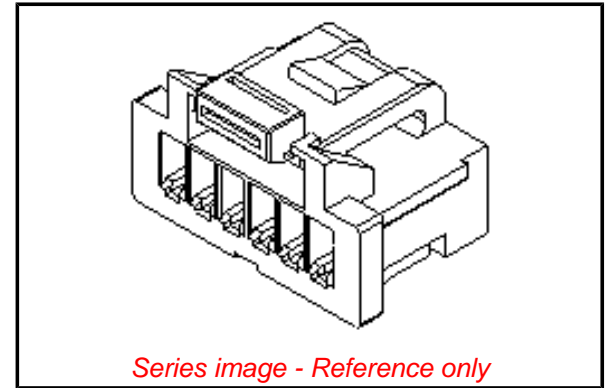

Agency Certification

UL E29179

General

Product Family	Crimp Housings
Series	501330
Application	Signal, Wire-to-Board
Overview	Pico-Clasp™ Wire-to-Board Connectors
Product Name	Pico-Clasp™
UPC	822348529537

Physical

Circuits (maximum)	12
Color - Resin	White
Gender	Female
Glow-Wire Compliant	No
Lock to Mating Part	Yes
Material - Resin	Nylon
Net Weight	100.100/mg
Number of Rows	1
Packaging Type	Bag
Panel Mount	No
Pitch - Mating Interface	1.00mm
Polarized to Mating Part	Yes
Stackable	No
Temperature Range - Operating	-40°C to +105°C

Electrical

Current - Maximum per Contact 1.0A

Material Info

Reference - Drawing Numbers

Packaging Specification	SPK-501330-001
Product Specification	PS-501331-001, PS-501568-001, PS-504449-001, RPS-501331-001, RPS-501331-002, RPS-501331-003, RPS-501331-005, RPS-501331-006, RPS-501331-007, RPS-501331-009, RPS-501331-010, RPS-501331-012, RPS-501331-013, RPS-501568-002, RPS-501568-003, RPS-501568-004, RPS-501568-005, RPS-501568-009, RPS-501568-010, RPS-501568-011, RPS-501568-012, RPS-501940-001
Sales Drawing	SD-501330-002

EU ELV

Not Relevant

EU RoHS

Compliant

REACH SVHC

Not Contained Per
-ED/79/2015 (17
December 2015)

Halogen-Free

Status

Low-Halogen

Need more information on product environmental compliance?

Email productcompliance@molex.com
Please visit the [Contact Us](#) section for any non-product compliance questions.

China ROHS
ELV

Green Image
Not Relevant

Search Parts in this Series

[501330 Series](#)

Mates With

[501331 PCB Header](#) . [501568 PCB Header](#)

Use With

[501334 Crimp Terminal](#)

This document was generated on 03/29/2016

PLEASE CHECK WWW.MOLEX.COM FOR LATEST PART INFORMATION