



SILICON LABS

# Humidity/Temp/Optical EVB UG

---

## HUMIDITY/TEMPERATURE/OPTICAL SENSOR EXPANSION BOARD USER'S GUIDE

---

### 1. Introduction

The SLSTK3201A Zero Gecko Starter Kit includes a Humidity/Temp/Optical Expansion Board (BRD8001A) and a EFM32ZG-STK3200 Zero Gecko STK. This document describes the Humidity/Temp/Optical Expansion Board and a weather station demo based on it.

The Humidity/Temp/Optical Expansion Board is a hardware plug-in card for the EFM32 starter kits (STKs). It contains the Si7013 humidity and temperature sensor as well as the Si1147 UV and proximity sensor. A weather station software demo is available to download to the Zero or Tiny Gecko STK through simplicity studio. When downloaded to the EFM32ZG-STK3200 Zero Gecko STK or the EFM32TG-STK3300 Tiny Gecko STK, the demo displays humidity, temperature, and UV index and performs gesture detection. Right or left gestures move the display type and, on the temperature screen, up or down gestures move the display between °C or °F.

#### 1.1. Features

- Si7013 Humidity and Temperature sensor
- Si1147 proximity sensor
- 3 IR LEDs for gesture detection
- 20-pin expansion header
- Battery operation with long battery life

#### 1.2. Getting Started

The first step to get started with your new Humidity/Temp/Optical Expansion board is to go to [www.silabs.com/simplicity-studio](http://www.silabs.com/simplicity-studio).

The simplicity studio software package contains all the tools, drivers, software examples and documentation needed to use the Humidity/Temp/Optical Expansion board.

You will need to connect the Humidity/Temp/Optical Expansion board to the EFM32ZG-STK3200 Zero Gecko STK or the EFM32TG-STK3300 Tiny Gecko STK. The demo code can be loaded using the USB cable and J-Link debug interface.

# Humidity/Temp/Optical EVB UG

## 2. Weather Station Demo

### 2.1. Loading the Demo

Connect the USB cable to the STK and launch Simplicity Studio. Click on “Detect connected device” then click on the Demos button (top right) and select the weather station demo from the list. Make sure the Bat/Dbg switch on the STK is set to DBG and click Start to download the demo. The following figures show the Zero Gecko STK screens.

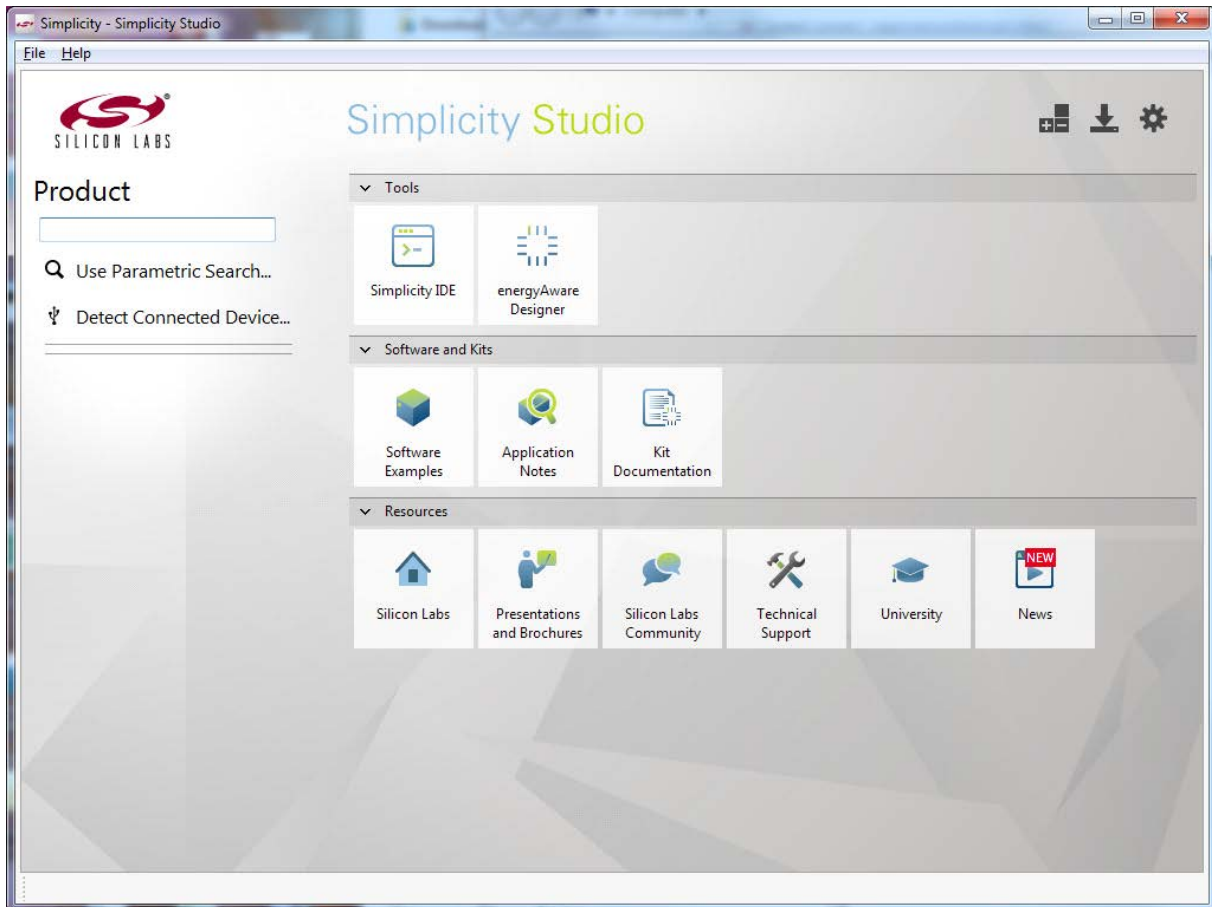

Figure 1. Simplicity Studio

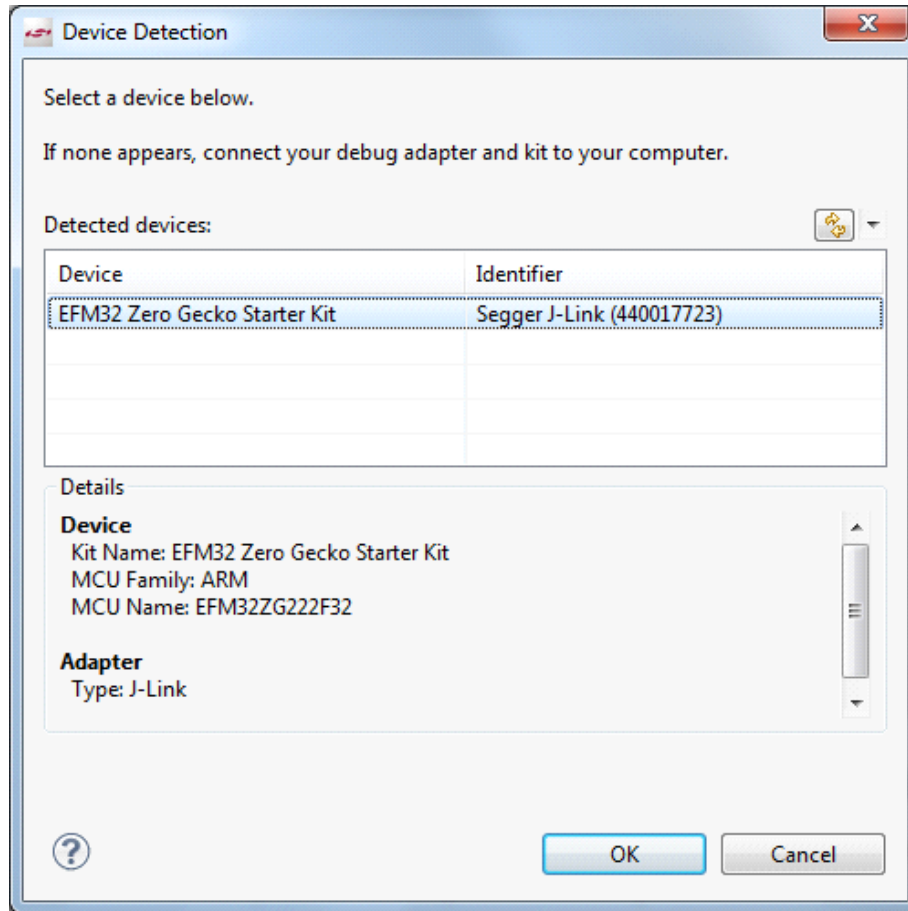

Figure 2. Device Detection

# Humidity/Temp/Optical EVB UG

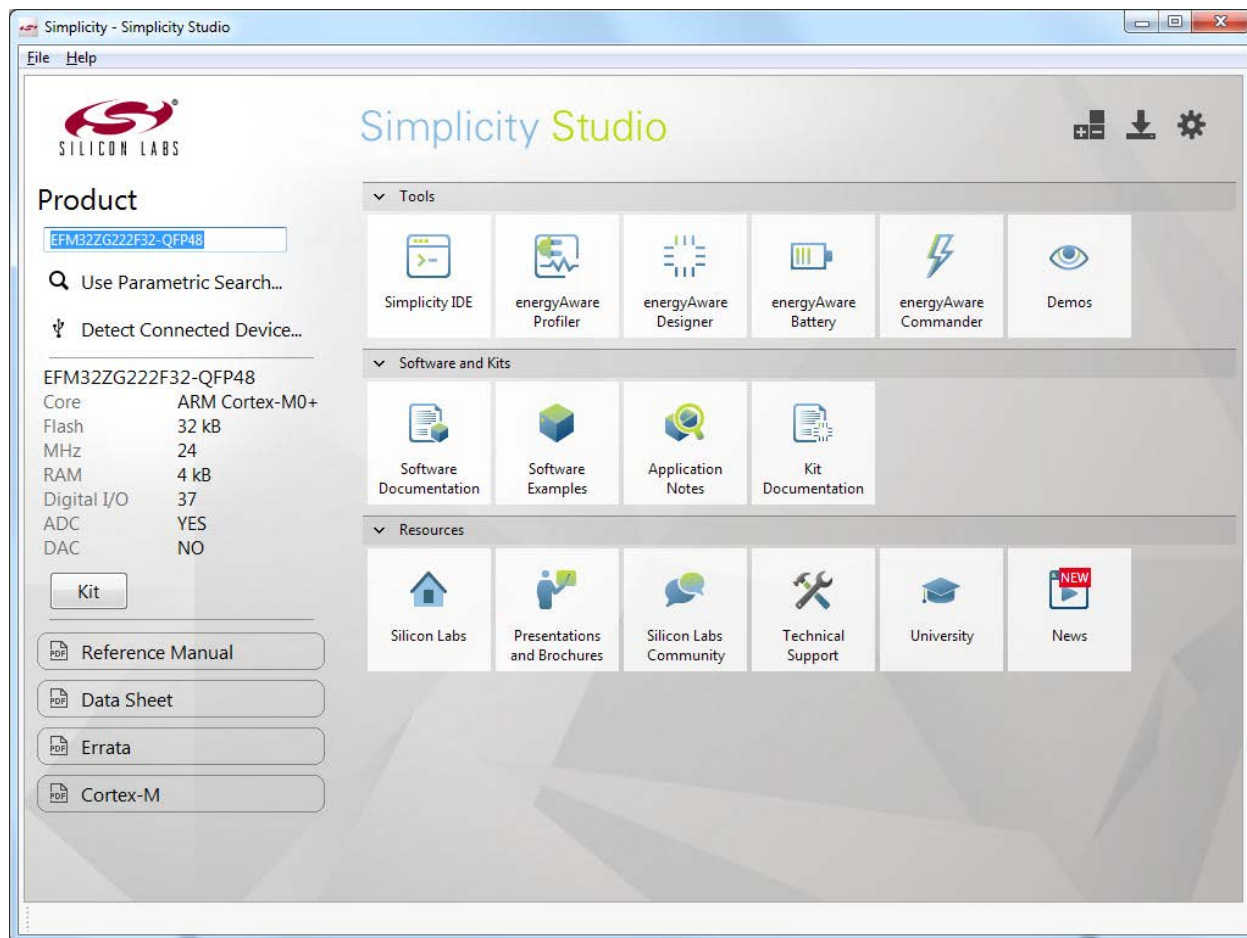

Figure 3. Select Demos

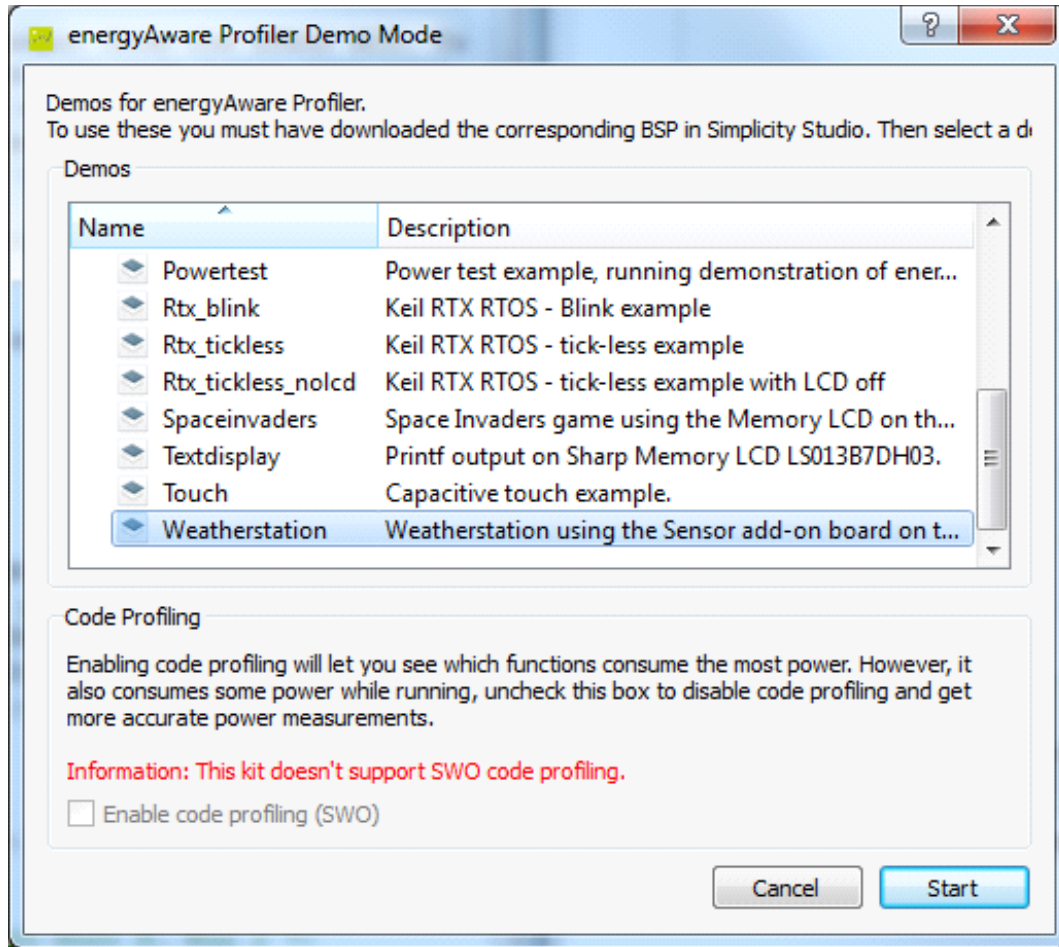

Figure 4. Demo Selection

# Humidity/Temp/Optical EVB UG

---

## 2.2. Using the Demo

After download, the USB cable can be disconnected and the demo will run from battery power by switching the Bat/Dbg switch to battery.

The demonstration will first show a start screen with some basic instructions. In order to conserve power the demonstration code wakes up every few seconds and looks for a proximity event before looking for gestures. To initiate a proximity event, hold your hand (with fingers closed) over the Humidity/Temp/Optical Expansion board. Once the proximity event has been detected, gesture detection is enabled. The gesture control state is fairly high-power compared to the idle state, so the code will automatically terminate gesture detection after one minute of inactivity. Swiping your hand across the Humidity/Temp/Optical Expansion board in left and right motions will change the display as shown in Figure 5.

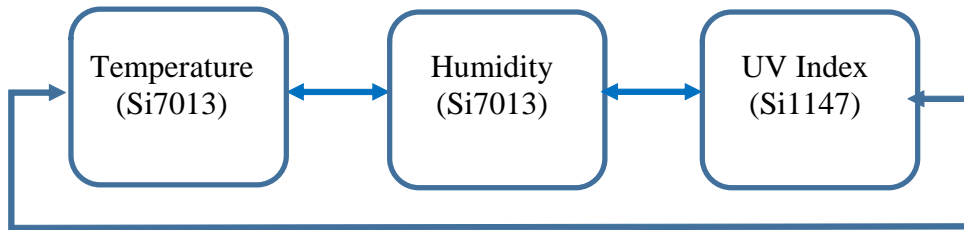

**Figure 5. Displays**

While on the temperature display, an up or down swipe motion will change the units to °C or °F.

## 3. Block Diagram

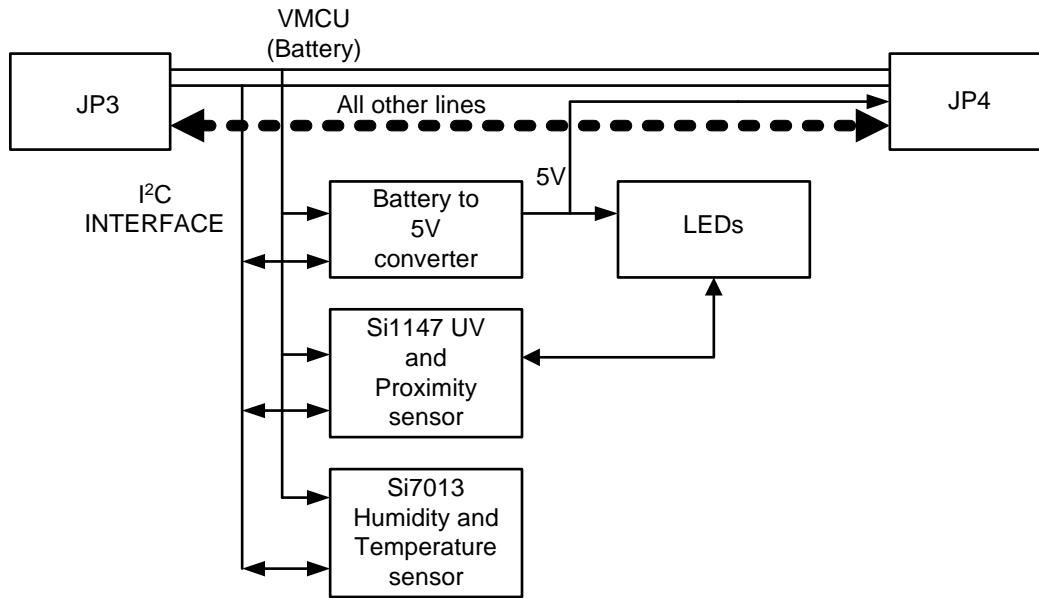

Figure 6. Humidity/Temp/Optical Expansion Board Component Layout

# Humidity/Temp/Optical EVB UG

## 4. Hardware Layout

### 4.1. Humidity/Temp/Optical Expansion Board

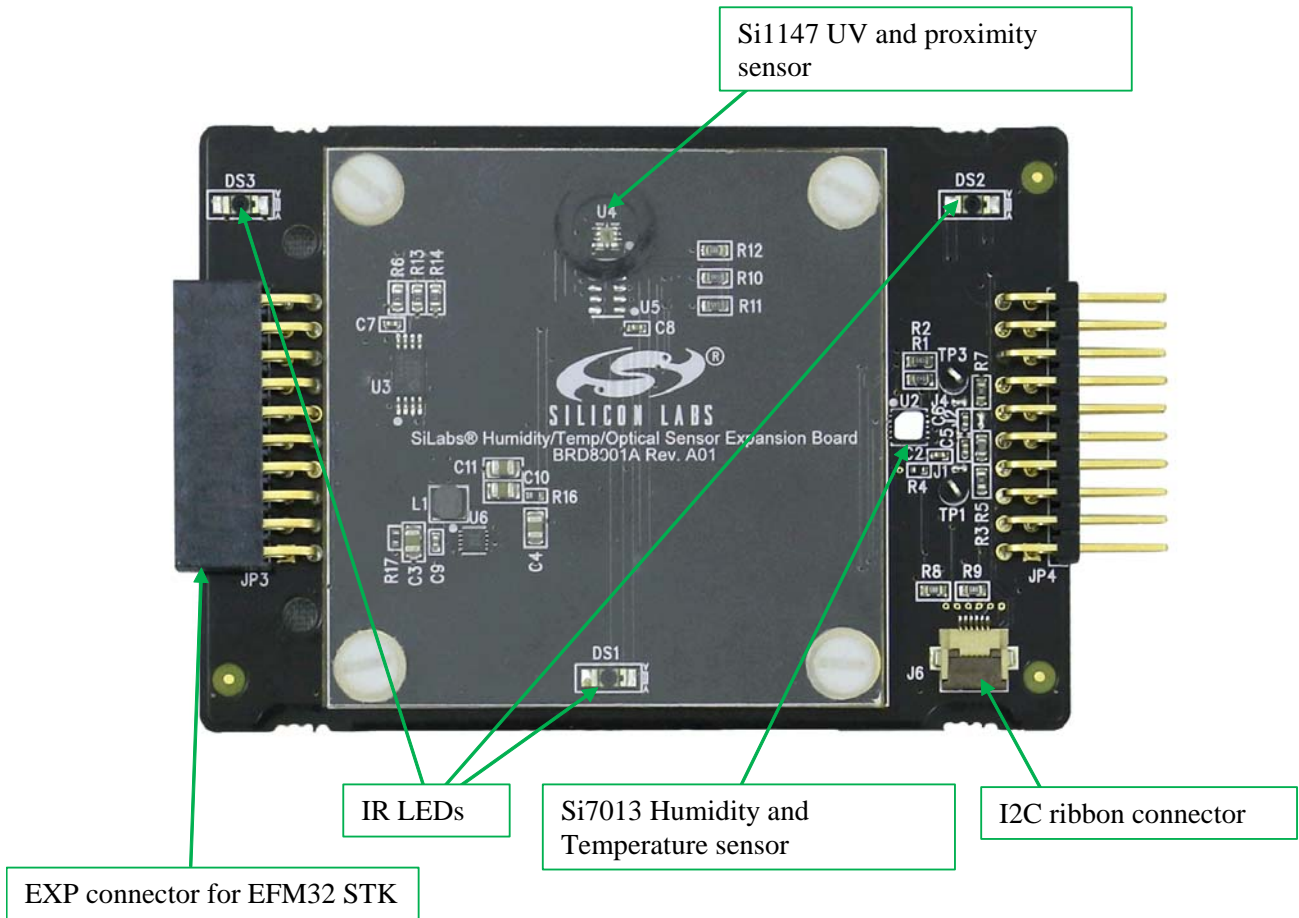
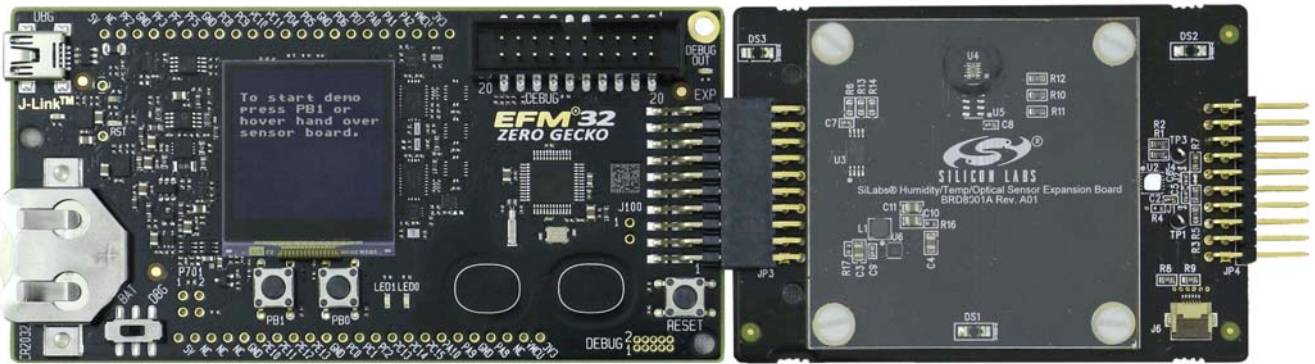

Figure 7. Assembled Demo Platform



## 4.2. Humidity/Temp/Optical Expansion Board Connected to Zero Gecko STK



**Figure 8. Humidity/Temp/Optical Expansion Board Connected to Zero Gecko STK**

Hover hand to create a proximity event (Figure 9).

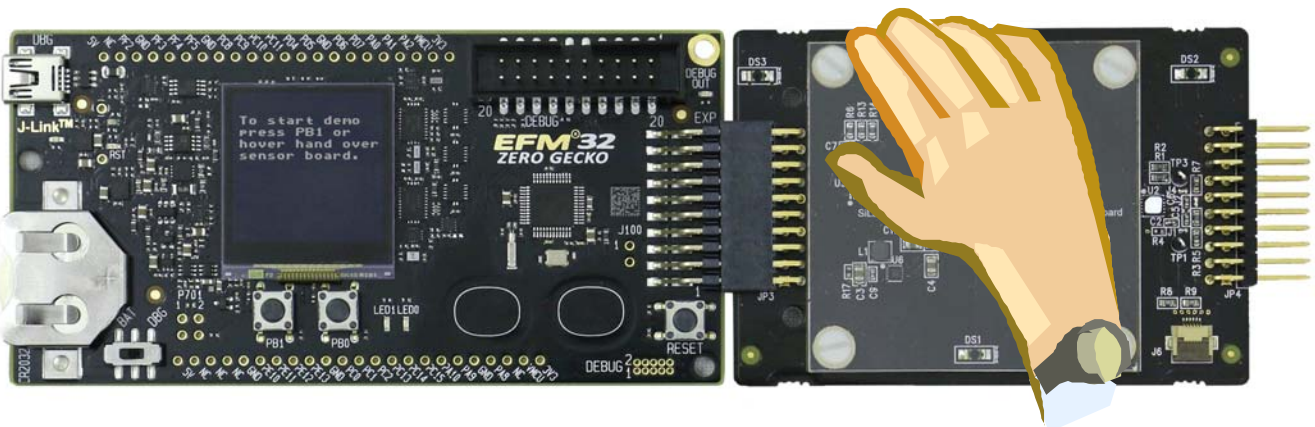

**Figure 9. Hover Gesture**

Swipe hand right or left to change display (Figure 10). Swipe up and down to change temperature display units.

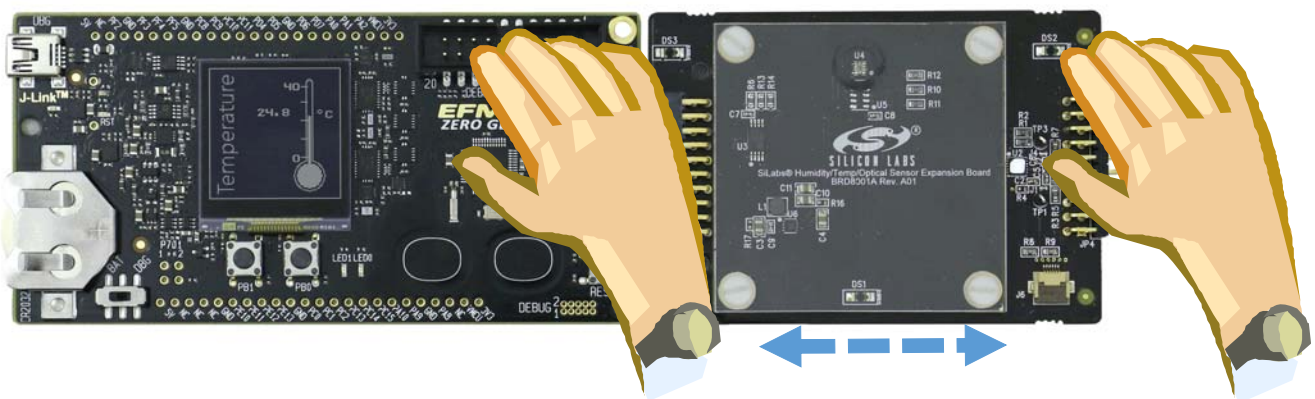

**Figure 10. Left/Right Swipe Gesture**

# Humidity/Temp/Optical EVB UG

---

## 5. Connectors

On the left hand side of the board there is a right-angle 20-pin expansion header is to allow connection to the EFM32 STK board. This connector is not currently compatible with Wonder, Giant, or Leopard Gecko STKs. However, with hardware modifications, the Humidity/Temp/Optical expansion board can be used with these STKs as well. On the right hand side of the board there is another connector to allow connection to another plug-in card. J6 is a flat ribbon cable connector to connect other devices such as additional sensors to the I<sup>2</sup>C bus.

## 6. Schematics, Assembly Drawings and BOM

The schematics, assembly drawings and bill of materials (BOM) for the Humidity/Temp/Optical expansion board are available through simplicity studio when the EXP documentation package has been installed.

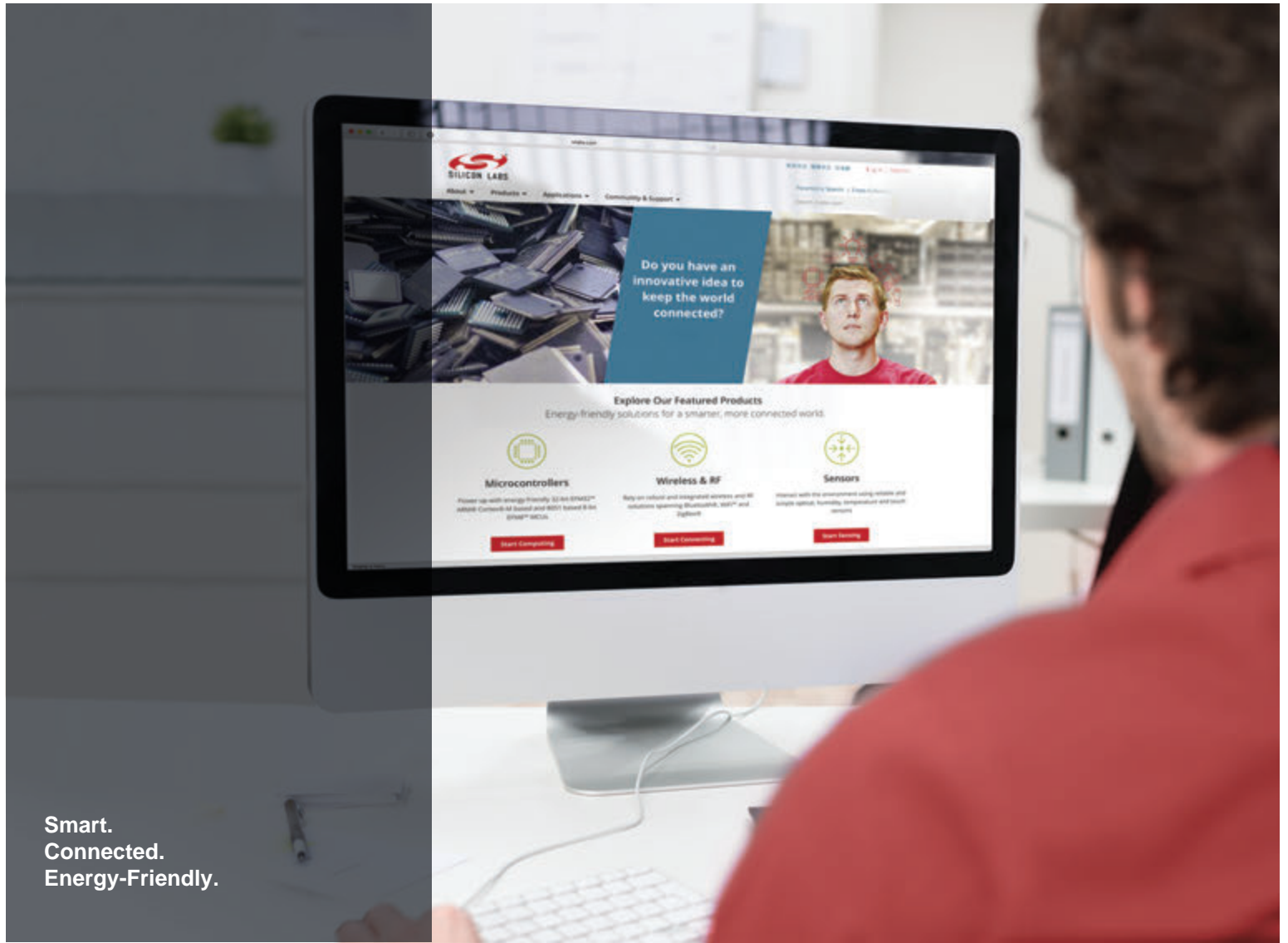

Smart.  
Connected.  
Energy-Friendly.



**Products**  
[www.silabs.com/products](http://www.silabs.com/products)



**Quality**  
[www.silabs.com/quality](http://www.silabs.com/quality)



**Support and Community**  
[community.silabs.com](http://community.silabs.com)

**Disclaimer**

Silicon Laboratories intends to provide customers with the latest, accurate, and in-depth documentation of all peripherals and modules available for system and software implementers using or intending to use the Silicon Laboratories products. Characterization data, available modules and peripherals, memory sizes and memory addresses refer to each specific device, and "Typical" parameters provided can and do vary in different applications. Application examples described herein are for illustrative purposes only. Silicon Laboratories reserves the right to make changes without further notice and limitation to product information, specifications, and descriptions herein, and does not give warranties as to the accuracy or completeness of the included information. Silicon Laboratories shall have no liability for the consequences of use of the information supplied herein. This document does not imply or express copyright licenses granted hereunder to design or fabricate any integrated circuits. The products are not designed or authorized to be used within any Life Support System without the specific written consent of Silicon Laboratories. A "Life Support System" is any product or system intended to support or sustain life and/or health, which, if it fails, can be reasonably expected to result in significant personal injury or death. Silicon Laboratories products are not designed or authorized for military applications. Silicon Laboratories products shall under no circumstances be used in weapons of mass destruction including (but not limited to) nuclear, biological or chemical weapons, or missiles capable of delivering such weapons.

**Trademark Information**

Silicon Laboratories Inc.®, Silicon Laboratories®, Silicon Labs®, SiLabs® and the Silicon Labs logo®, Bluegiga®, Bluegiga Logo®, Clockbuilder®, CMEMS®, DSPLL®, EFM®, EFM32®, EFR®, Ember®, Energy Micro, Energy Micro logo and combinations thereof, "the world's most energy friendly microcontrollers", Ember®, EZLink®, EZRadio®, EZRadioPRO®, Gecko®, ISOModem®, Precision32®, ProSLIC®, Simplicity Studio®, SiPHY®, Telegesis, the Telegesis Logo®, USBXpress® and others are trademarks or registered trademarks of Silicon Laboratories Inc. ARM, CORTEX, Cortex-M3 and THUMB are trademarks or registered trademarks of ARM Holdings. Keil is a registered trademark of ARM Limited. All other products or brand names mentioned herein are trademarks of their respective holders.



Silicon Laboratories Inc.  
400 West Cesar Chavez  
Austin, TX 78701  
USA

<http://www.silabs.com>