



Product information GSP 3 M20 schwarz/black

Industrial Connecting Solutions:Rectangular Connectors:Valve Connectors (Type A -B -C):Type A:Appliance Connectors (DIN EN 175 301-803):GSP 3 M20 schwarz/black

<https://e-catalog.hirschmann.com:443/link/57078-24228-256261-256266-256270-276255-35191/en/conf/uistate>

Name	GSP 3 M20 schwarz/black
	
	appliance connector with thread, appliance connector, threaded sleeve, grip ring, o-ring (NBR)
Delivery informations	
Availability	available
Product description	
Description	appliance connector with thread, appliance connector, threaded sleeve, grip ring, o-ring (NBR)
Type	GSP 3 M20 schwarz/black
Order No.	931 297-006
Number of contacts	3 + PE
Cable gland	M 20
Standard	DIN EN 175 301-803-A
Housing Color	black
Construction type	A
Technical data	
Rated voltage	AC/DC 400 V
Rated current	16 A
Contact resistance	<= 4 mOhm
Type of termination	solder
Mounting	screw
Material	
Contact surface material	Sn
Contact bearer material	PA
Housing material	PA
Environmental conditions	
Protection class (IEC 60529)	IP 65 (gasket necessary) (mated)
Pollution severity	3
Temperature range	-40 °C to +125 °C
Inflammability class	
Contact bearer	94 HB
Approvals	
VDE	VDE
SEV	SEV
Packing unit	
Packaging unit	200 pieces

Picture
Drawing

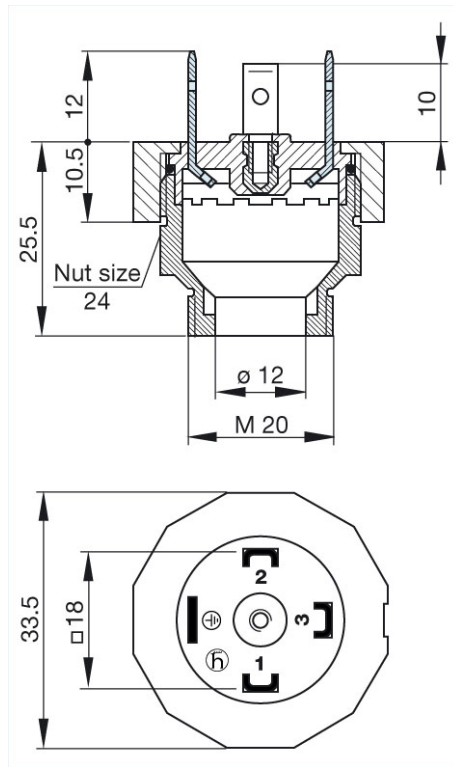

Belden Deutschland GmbH
 Im Gewerbepark 2
 58579 Schalksmühle
 Germany
 Phone: +49 7127/14-1806
 E-Mail: icos-sales@belden.com

The information published in the websites has been compiled as carefully as possible. It is subject to alteration without notice in technical as well as in price-related/commercial respect. The complete information and data were available on user documentation. Mandatory information can only be obtained by a concrete query.