



GARDTEC

Revision	Date	Approved	Name

Part Number:

SC1000-W1SS

Material: SUS304 Stainless Steel Wire
 Finish:Electrolysis
 Ring Diameter: 2.3mm
 Rib Diameter: 2.3mm
 General Tolerance Unless Noted:±0.5mm
 Unit: mm
 RoHS Compliant

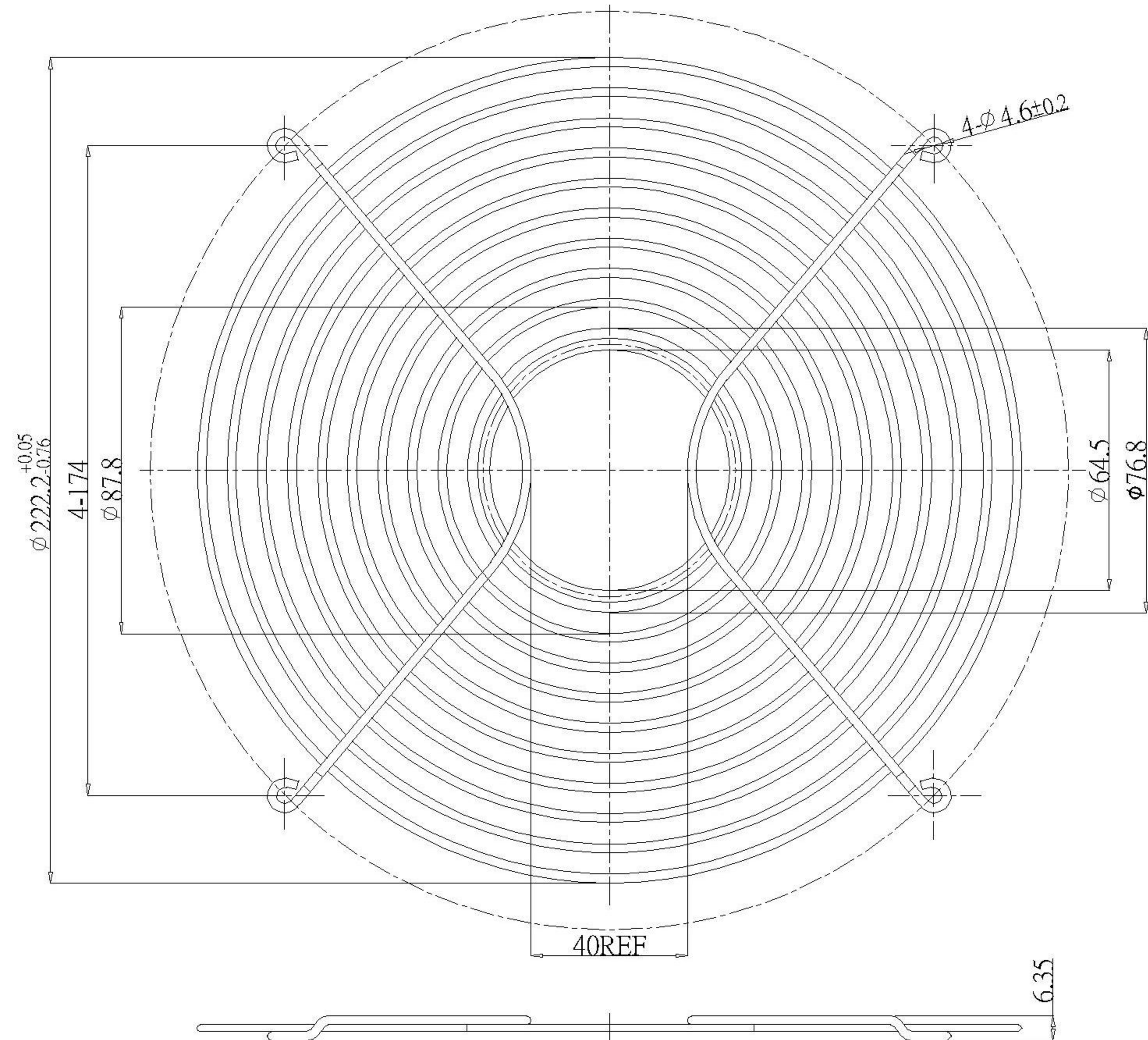

These drawings are the property of Gardtec, Inc and cannot be reproduced for or communicated to a third party without the express written permission of Gardtec, Inc.