

2 POSITION LATCHED WIRE-TO-WIRE CONNECTOR

Compact Connector with Modular Technology

TE Connectivity (TE) introduces the 2 position latched wire-to-wire connector. This connectors utilizes poke-in termination which supports easy field installation as no tools are required. The compact design makes this connector ideal for applications where space is a constraint. Suitable for indoor lighting applications, this connector comes in four different colors and one modular design enabling ease of identification and assembly.



Applications

- Indoor lighting

Electrical

- **Current rating:**
 - 16 AWG: UL2459 @ 600V 5A; UL1977 @ 600V - 8A
 - 18 AWG: UL2459 @ 600V 5A; UL1977 @ 600V - 8A
 - 22 AWG: UL2459 @ 600V 3A; UL1977 @ 600V - 3A
- **Voltage rating:** 600 VAC Max.
- **Dielectric strength:** 2200 VAC

Mechanical

- **Operating Temperature:** -40°C to +105°C
- **Durability:** 10 cycles

Specifications

- **Application Specification:** [114-137159](#)
- **Product Specification:** [108-137159](#)
- **UL1977 Approval** E28476
- **UL2459 Approval** E308110
- **Multi-pole Splicing Wire Connectors**
- **Multi-pole Splicing Wire Connectors Certified for Canada**

Materials

- **Housing:** PA, UL94 V-0
- **Contact:** Copper Alloy with Tin plating

Key Benefits









- Modular Technology enables flexibility in design
- Tool free, easy and fast installation with poke-in contact feature
- Compact size design for space saving
- Color configurations enables easy identification

Colors

- Black
- Orange
- Red
- White

2 POSITION LATCHED WIRE-TO-WIRE CONNECTOR

Product Selection Information

Type	Description	Color	Part Number	
	Plug	2 Position Latched Poke-In Wire-to-Wire Connector	Natural	2834048-1
	Receptacle	2 Position Latched Poke-In Wire-to-Wire Connector	Natural	2834049-1
	Plug	2 Position Latched Poke-In Wire-to-Wire Connector	Black	2834048-2
	Receptacle	2 Position Latched Poke-In Wire-to-Wire Connector	Black	2834049-2
	Plug	2 Position Latched Poke-In Wire-to-Wire Connector	Orange	2834048-3
	Receptacle	2 Position Latched Poke-In Wire-to-Wire Connector	Orange	2834049-3
	Plug	2 Position Latched Poke-In Wire-to-Wire Connector	Red	2834048-4
	Receptacle	2 Position Latched Poke-In Wire-to-Wire Connector	Red	2834049-4

Type	Description	Color	Part Number	
	Modular Receptacle	2 Position Latched Poke-In Wire-to-Wire Connector	Natural	1-2834049-1
	Modular Receptacle	2 Position Latched Poke-In Wire-to-Wire Connector	Black	1-2834049-2
	Modular Receptacle	2 Position Latched Poke-In Wire-to-Wire Connector	Orange	1-2834049-3
	Modular Receptacle	2 Position Latched Poke-In Wire-to-Wire Connector	Red	1-2834049-4

Dimensions

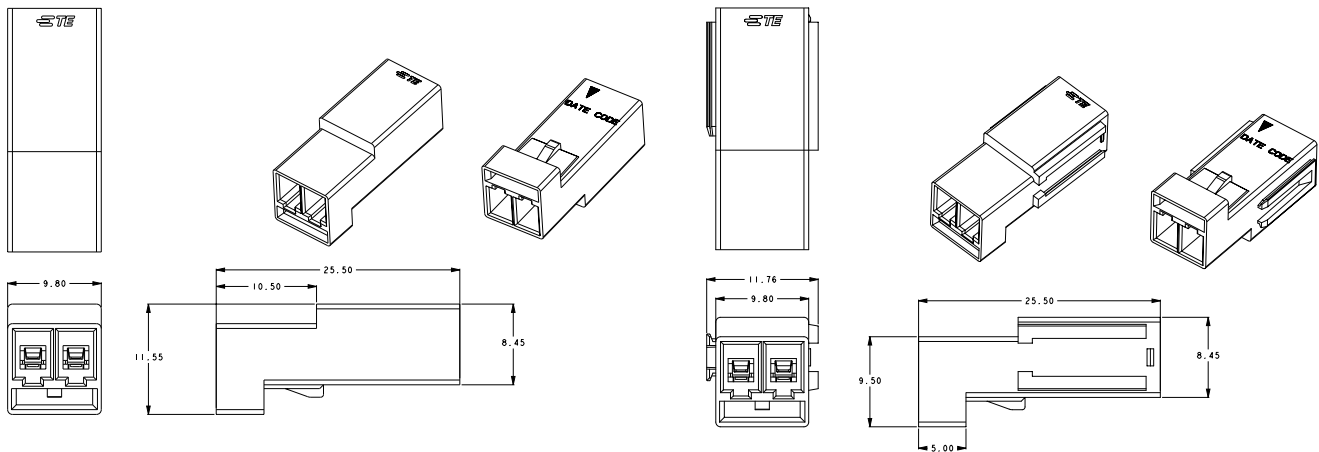

te.com

© 2016 TE Connectivity Ltd. Family of Companies. All Rights Reserved. TE, TE Connectivity, and the TE connectivity (logo) are trademarks of the TE Connectivity Ltd. family of companies. Other logos, product and Company names mentioned herein may be trademarks of their respective owners.
1-1773872-8 JN 7/2016

USA: +1 (800) 522-6752
Canada: +1 (905) 475-6222
Mexico: +52 (0) 55-1106-0800
Latin/S. America: +54 (0) 11-4733-2200
Germany: +49 (0) 6251-133-1999

UK: +44 (0) 800-267666
France: +33 (0) 1-3420-8686
The Netherlands: +31 (0) 73-6246-999
China: +86 (0) 400-820-6015