

UDS1

Dimensions (mm)	∅ 48 x 18.5
Voltage (V)	6-230
Speed (rpm) 50 Hz	500
60 Hz	600
Pole number	12
Running torque (cNm) 50 Hz	0.77
60 Hz	0.68
Power output (W) 50 Hz	0.40
60 Hz	0.43
Gear combination	D, M, B, F, V, J



Note: Running torque = Pull-out torque (starting motor at no load, then torque increase)
Running torque and Power output are minimum values, at rated voltage and motor temperature 23°C

Standard Data

Climatic class	wide-spread according to DIN IEC 60721-2-1 : 2015
Ambient temperature operation	°C -15...+60
Ambient temperature storage	°C -20...+100
Thermal resistance at f=0 R _{therm}	17 K/W
Thermal class	105 (A) according to DIN EN 60085 : 2008 for approval standard 130 (B) according to DIN EN 60085 : 2008 for approval UL/CSA
Approval	standard/UL/CSA
Mounting	any position
Electrical connection	cable
Protection	IP40 according to DIN EN 60529 : 2014
Weight	102 g
Rotor stalling	motor can be stopped when voltage is applied, without being overheated
Bearings	plastic, self-lubricating
Electric strength	according to DIN EN 60034-1/DIN EN 60335-1

Order Reference

Type	Synchronous Motor	UDS1	0	N	B4	R	N
Rotor shaft, mounting	0 centring 8 mm, shaft 1.5 mm, clip 1 centring 8 mm, shaft 2.0 mm, clip						
Approval	N Approval Standard U Approval UL/CSA						
Voltage/Frequency	See next page						
Direction	R clockwise rotation L Counter-clockwise rotation						
Cable	N cable 150 mm (other on request)						

All specifications are representative only and maybe subject to variation. For confirmation of values, please contact Johnson Electric.
Please also read "Saia Motors Important Notes" on catalog or at www.johnsonelectric.com/SaiaMotorsNotes

Technical Data

Rated frequency	Hz	50	60
Speed n	rpm	500	600
Power consumption*	W	2.4	1.8
Power output	W	0.40	0.43
Running torque	cNm	0.77	0.68
Rotor inertia J _R	gcm ²	11	
Detent torque M _s	cNm	0.23 (in direction of rotation)	
Tolerance of voltage		standard power supply system + 10% / - 10%	
Winding temperature T _{max}	°C	105 for approval Standard (N) 130 for approval UL/CSA	

Direction of rotation: clockwise or counter-clockwise

UDS1	Rated voltage U _N	V	6	12	24	36	42	48	60	110	110-120	230	110/230	24/48
	Duty cycle	%	100	100	100	100	100	100	100	100	100	100	100	100
	Resistance R ₂₀	Ω	5.5	24	78	193	285	330	500	1830	1830	7500	2180/5500	105/260
	Winding code		A6/F6	B1/G1	B4/G4	B6/G6	B8/G8	C1/H1	C2/H2	C8/H8	D1/J1	D5/J5	R1/S1	R4/S4
UDS1 Approval U	Rated voltage U _N	V	6	12	24	48	100	110	110-120	230	110/230	24/48		
	Duty cycle	%	100	100	100	100	100	100	100	100	100	100		
	Resistance R ₂₀	Ω	5.5	24	78	330	1350	1830	1830	7500	2180/5500	105/260		
	Winding code		A6/F6	B1/G1	B4/G4	C1/H1	C7/H7	C8/H8	D1/J1	D5/J5	R1/S1	R4/S4		
UDS3	Rated voltage U _N	V	6	12	24	36	42	48	60	110	230	110/230	24/48	
	Duty cycle	%	100	100	100	100	100	100	100	100	100	100	100	
	Resistance R ₂₀	Ω	5.5	24	78	193	285	330	500	1830	7500	2180/5500	105/260	
	Winding code		A6/F6	B1/G1	B4/G4	B6/G6	B8/G8	C1/H1	C2/H2	C8/H8	D5/J5	R1/S1	R4/S4	
UDS4	Rated voltage U _N	V	12	24	42	48	110-120	230						
	Duty cycle	%	100	100	100	100	100	100						
	Resistance R ₂₀	Ω	23	98	322	390	2200	8700						
	Winding code		B1/G1	B4/G4	B8/G8	C1/H1	D1/J1	D5/J5						

*can vary for different windings (rated voltages)

Dimensions

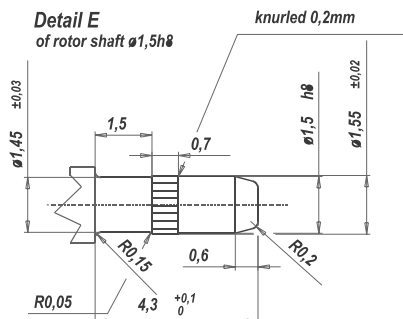
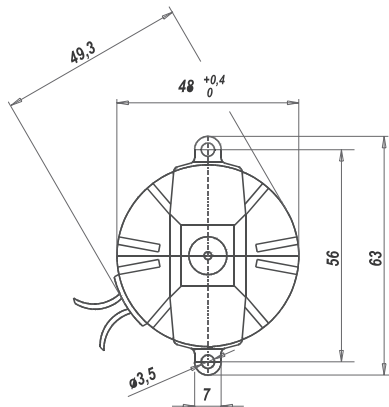

Mounting with screw clip
(item no. 4186 48200)

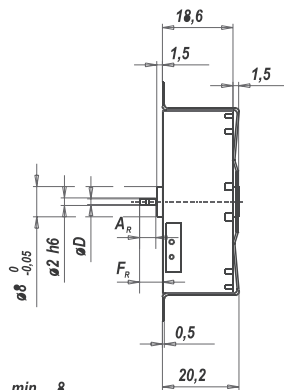

Mounting with snap-on clip
(item no. 4199 48000)

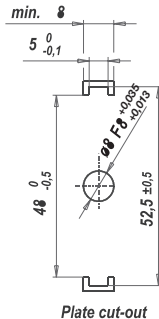
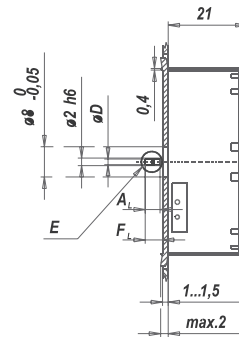

∅D Rotor shaft	Clockwise		counter clockwise	
	Dim. A _R	Dim. F _R	Dim. A _L	Dim. F _L
1,5h8 ⁰ _{-0,014}	4,3 ^{+0,1}	6,05	4,3 ^{+0,1}	6,45
2h6 ⁰ _{-0,006}	—	6,05	—	6,45