

# 2N6344A, 2N6348A, 2N6349A

Preferred Device



Expertise Applied | Answers Delivered

## Triacs

### Silicon Bidirectional Thyristors

Designed primarily for full-wave AC control applications, such as light dimmers, motor controls, heating controls and power supplies; or wherever full-wave silicon gate controlled solid-state devices are needed. Triac type thyristors switch from a blocking to a conducting state for either polarity of applied anode voltage with positive or negative gate triggering.

#### Features

- Blocking Voltage to 800 V
- All Diffused and Glass Passivated Junctions for Greater Parameter Uniformity and Stability
- Small, Rugged, Thermowatt Construction for Low Thermal Resistance, High Heat Dissipation and Durability
- Gate Triggering Guaranteed in all Four Quadrants
- For 400 Hz Operation, Consult Factory
- 8.0 A Devices Available as 2N6344 thru 2N6349
- Pb-Free Packages are Available\*

Littelfuse.com

**TRIACS**  
**12 AMPERES RMS**  
**600 thru 800 VOLTS**

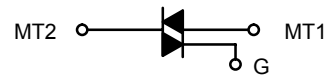

#### MARKING DIAGRAM

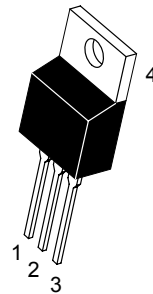

TO-220AB  
CASE 221A  
STYLE 4

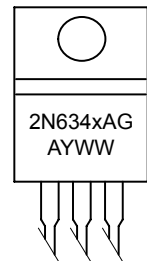

2N634xA = Device Code  
          x = 4, 8, or 9  
A = Assembly Location  
Y = Year  
WW = Work Week  
G = Pb-Free Package

#### PIN ASSIGNMENT

PIN ASSIGNMENT	
1	Main Terminal 1
2	Main Terminal 2
3	Gate
4	Main Terminal 2

#### ORDERING INFORMATION

See detailed ordering and shipping information in the package dimensions section on page 2 of this data sheet.

**Preferred** devices are recommended choices for future use and best overall value.

## 2N6344A, 2N6348A, 2N6349A

### MAXIMUM RATINGS

Characteristics	Symbol	Value	Unit
*Peak Repetitive Off-State Voltage (Note 1) (Gate Open, $T_J = -40$ to $+110^\circ\text{C}$ , Sine Wave 50 to 60 Hz, Gate Open) 2N6344A, 2N6348A 2N6349A	$V_{\text{DRM}}$ , $V_{\text{RRM}}$	600 800	V
*On-State RMS Current (Full Cycle Sine Wave 50 to 60 Hz)  ( $T_C = +80^\circ\text{C}$ ) ( $T_C = +95^\circ\text{C}$ )	$I_{\text{T(RMS)}}$	12 6.0	A
*Peak Non-repetitive Surge Current (One Full Cycle, 60 Hz, $T_C = +80^\circ\text{C}$ ) Preceded and followed by rated current	$I_{\text{TSM}}$	100	A
Circuit Fusing Consideration ( $t = 8.3$ ms)	$I^2t$	59	$\text{A}^2\text{s}$
*Peak Gate Power ( $T_C = +80^\circ\text{C}$ , Pulse Width = 2.0 $\mu\text{s}$ )	$P_{\text{GM}}$	20	W
*Average Gate Power ( $T_C = +80^\circ\text{C}$ , $t = 8.3$ ms)	$P_{\text{G(AV)}}$	0.5	W
*Peak Gate Current (Pulse Width = 2.0 $\mu\text{s}$ ; $T_C = +80^\circ\text{C}$ )	$I_{\text{GM}}$	2.0	A
*Peak Gate Voltage (Pulse Width = 2.0 $\mu\text{s}$ ; $T_C = +80^\circ\text{C}$ )	$V_{\text{GM}}$	$\pm 10$	V
*Operating Junction Temperature Range	$T_J$	-40 to +125	$^\circ\text{C}$
*Storage Temperature Range	$T_{\text{stg}}$	-40 to +150	$^\circ\text{C}$

Stresses exceeding Maximum Ratings may damage the device. Maximum Ratings are stress ratings only. Functional operation above the Recommended Operating Conditions is not implied. Extended exposure to stresses above the Recommended Operating Conditions may affect device reliability.

\*Indicates JEDEC Registered Data.

1.  $V_{\text{DRM}}$  and  $V_{\text{RRM}}$  for all types can be applied on a continuous basis. Blocking voltages shall not be tested with a constant current source such that the voltage ratings of the devices are exceeded.

### THERMAL CHARACTERISTICS

Characteristic	Symbol	Max	Unit
*Thermal Resistance, Junction-to-Case	$R_{\theta\text{JC}}$	2.0	$^\circ\text{C/W}$
Maximum Lead Temperature for Soldering Purposes 1/8" from Case for 10 Seconds	$T_L$	260	$^\circ\text{C}$

### ORDERING INFORMATION

Device	Package	Shipping
2N6344A	TO-220AB	500 Units / Box
2N6344AG	TO-220AB (Pb-Free)	
2N6348A	TO-220AB	
2N6348AG	TO-220AB (Pb-Free)	
2N6349A	TO-220AB	
2N6349AG	TO-220AB (Pb-Free)	

## 2N6344A, 2N6348A, 2N6349A

### ELECTRICAL CHARACTERISTICS ( $T_C = 25^\circ\text{C}$ unless otherwise noted; Electricals apply in either direction)

Characteristic	Symbol	Min	Typ	Max	Unit
----------------	--------	-----	-----	-----	------

#### OFF CHARACTERISTICS

*Peak Repetitive Blocking Current ( $V_D = \text{Rated } V_{DRM}, V_{RRM}; \text{ Gate Open}$ )	$I_{DRM},$ $I_{RRM}$	-	-	10 2.0	$\mu\text{A}$ mA
$T_J = 25^\circ\text{C}$					
$T_J = 110^\circ\text{C}$					

#### ON CHARACTERISTICS

*Peak On-State Voltage ( $I_{TM} = \pm 17 \text{ A Peak}; \text{ Pulse Width} = 1 \text{ to } 2 \text{ ms}, \text{ Duty Cycle} \leq 2\%$ )	$V_{TM}$	-	1.3	1.75	V
Gate Trigger Current (Continuous dc) ( $V_D = 12 \text{ Vdc}, R_L = 100 \Omega$ )	$I_{GT}$				mA
Quadrant I: MT2(+), G(+) <span style="float: right;">All</span>		-	6.0	50	
Quadrant II: MT2(+), G(-) <span style="float: right;">2N6348A and 2N6349A only</span>		-	6.0	75	
Quadrant III: MT2(-), G(-) <span style="float: right;">All</span>		-	10	50	
Quadrant IV: MT2(-), G(+) <span style="float: right;">2N6348A and 2N6349A only</span>		-	25	75	
*MT2(+), G(+); MT2(-), G(-) $T_C = -40^\circ\text{C}$		-	-	100	
*MT2(+), G(-); MT2(-), G(+) $T_C = -40^\circ\text{C}$		-	-	125	
Gate Trigger Voltage (Continuous dc) ( $V_D = 12 \text{ Vdc}, R_L = 100 \Omega$ )	$V_{GT}$				V
Quadrant I: MT2(+), G(+) <span style="float: right;">All</span>		-	0.9	2.0	
Quadrant II: MT2(+), G(-) <span style="float: right;">2N6348A and 2N6349A only</span>		-	0.9	2.5	
Quadrant III: MT2(-), G(-) <span style="float: right;">All</span>		-	1.1	2.0	
Quadrant IV: MT2(-), G(+) <span style="float: right;">2N6348A and 2N6349A only</span>		-	1.4	2.5	
*MT2(+), G(+); MT2(-), G(-) $T_C = -40^\circ\text{C}$		-	-	2.5	
*MT2(+), G(-); MT2(-), G(+) $T_C = -40^\circ\text{C}$		-	-	3.0	
Gate Non-Trigger Voltage ( $V_D = \text{Rated } V_{DRM}, R_L = 10 \text{ k } \Omega, T_J = 110^\circ\text{C}$ ) *MT2(+), G(+); MT2(-), G(-); MT2(+), G(-); MT2(-), G(+)	$V_{GD}$	0.2	-	-	V
Holding Current ( $V_D = 12 \text{ Vdc}, \text{ Gate Open}$ ) Initiating Current = $\pm 200 \text{ mA}$	$I_H$	-	6.0	40	mA
$T_C = 25^\circ\text{C}$				75	
$*T_C = -40^\circ\text{C}$					
*Turn-On Time ( $V_D = \text{Rated } V_{DRM}, I_{TM} = 17 \text{ A}, I_{GT} = 120 \text{ mA},$ Rise Time = $0.1 \mu\text{s}$ , Pulse Width = $2 \mu\text{s}$ )	$t_{gt}$	-	1.5	2.0	$\mu\text{s}$

#### DYNAMIC CHARACTERISTICS

Critical Rate of Rise of Commutation Voltage ( $V_D = \text{Rated } V_{DRM}, I_{TM} = 17 \text{ A}, \text{ Commutating } di/dt = 6.1 \text{ A/ms},$ Gate Unenergized, $T_C = 80^\circ\text{C}$ )	$dv/dt(c)$	-	5.0	-	V/ $\mu\text{s}$
--	------------	---	-----	---	------------------

\*Indicates JEDEC Registered Data.

# 2N6344A, 2N6348A, 2N6349A

## Voltage Current Characteristic of Triacs (Bidirectional Device)

Symbol	Parameter
$V_{DRM}$	Peak Repetitive Forward Off State Voltage
$I_{DRM}$	Peak Forward Blocking Current
$V_{RRM}$	Peak Repetitive Reverse Off State Voltage
$I_{RRM}$	Peak Reverse Blocking Current
$V_{TM}$	Maximum On State Voltage
$I_H$	Holding Current

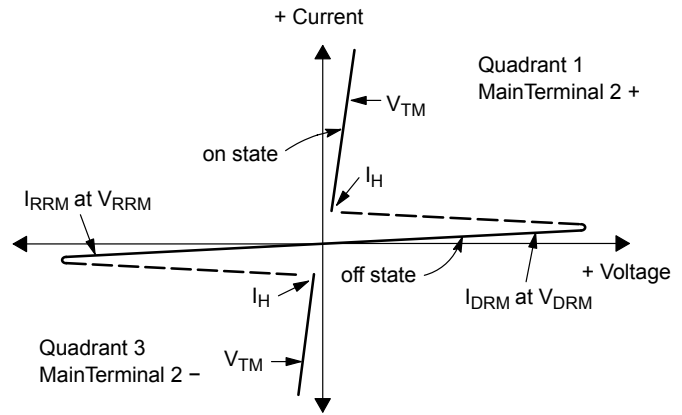

### Quadrant Definitions for a Triac

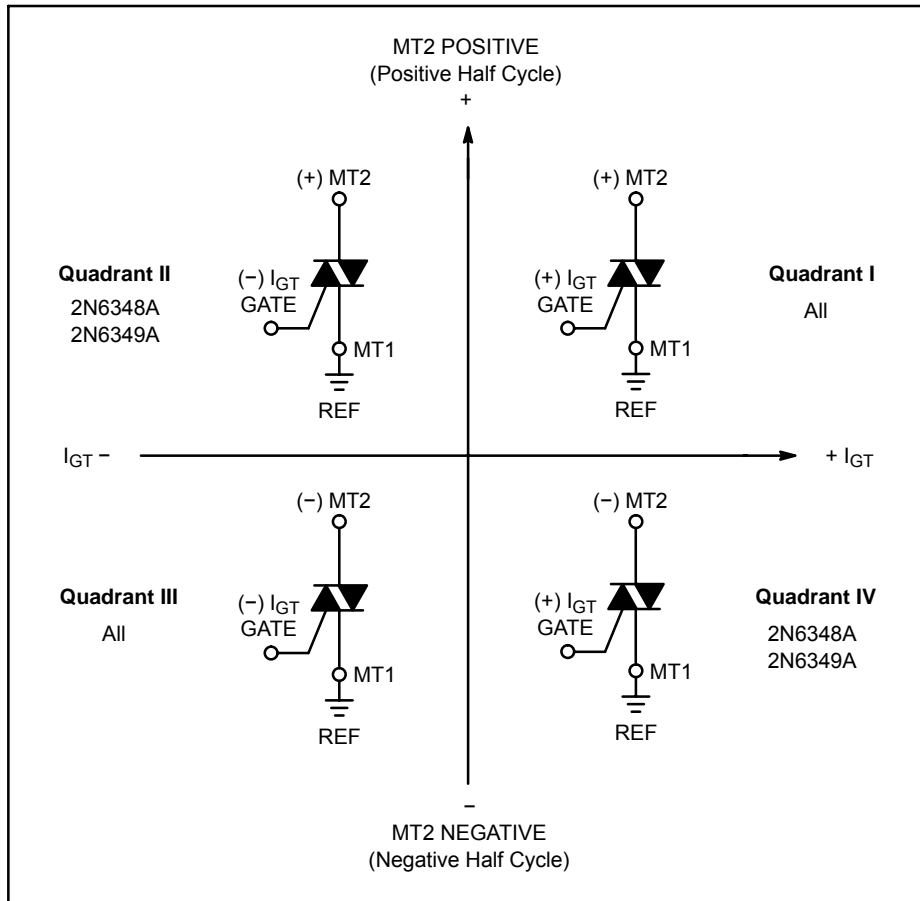

All polarities are referenced to MT1.  
With in-phase signals (using standard AC lines) quadrants I and III are used.

# 2N6344A, 2N6348A, 2N6349A

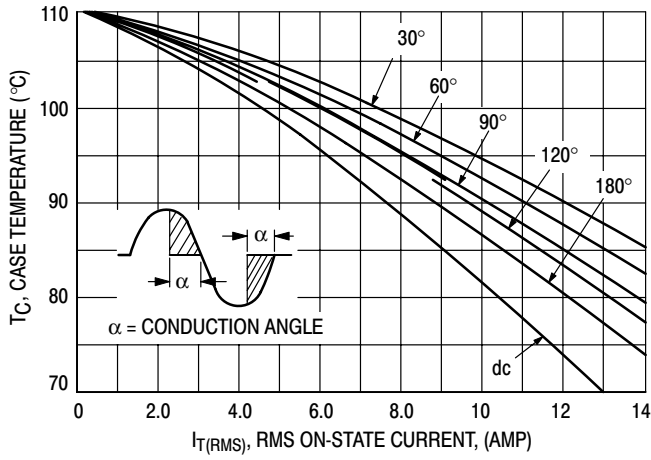

Figure 1. RMS Current Derating

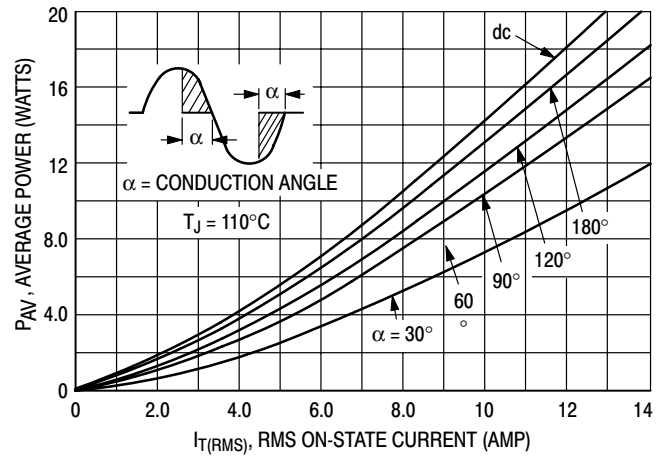

Figure 2. On-State Power Dissipation

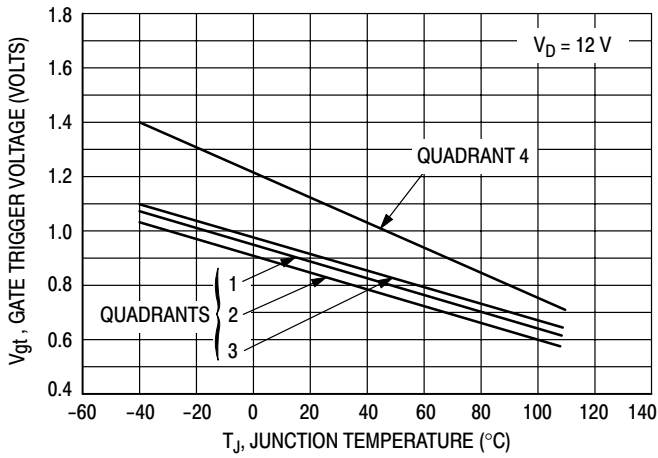

Figure 3. Typical Gate Trigger Voltage

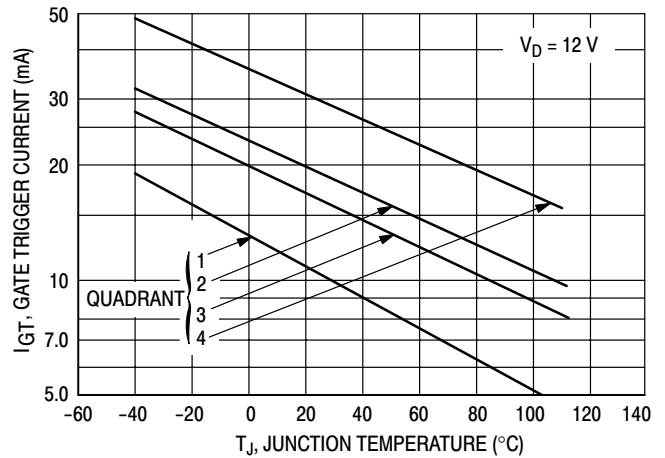

Figure 4. Typical Gate Trigger Current

# 2N6344A, 2N6348A, 2N6349A

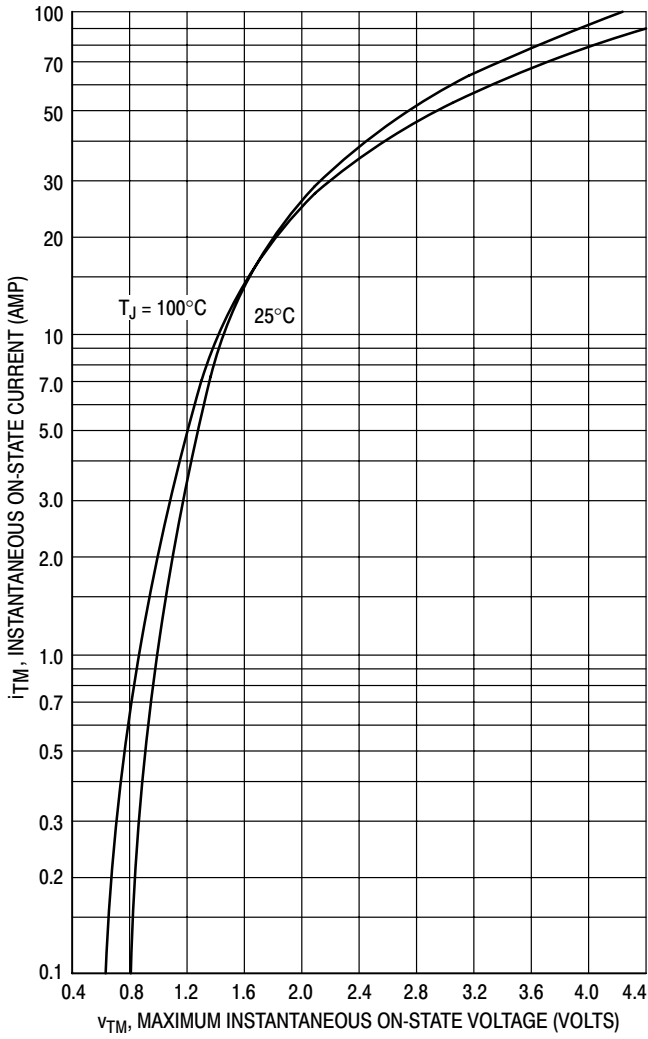

Figure 5. On-State Characteristics

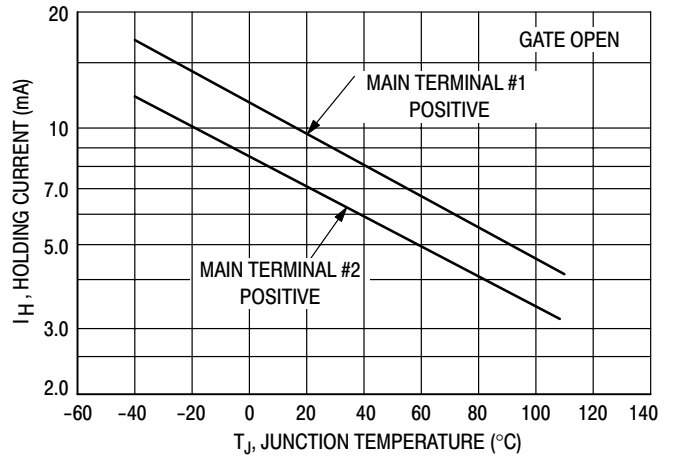

Figure 6. Typical Holding Current

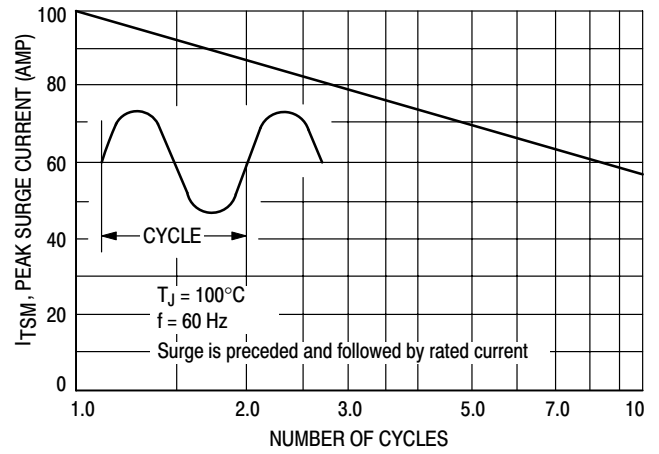

Figure 7. Maximum Non-Repetitive Surge Current

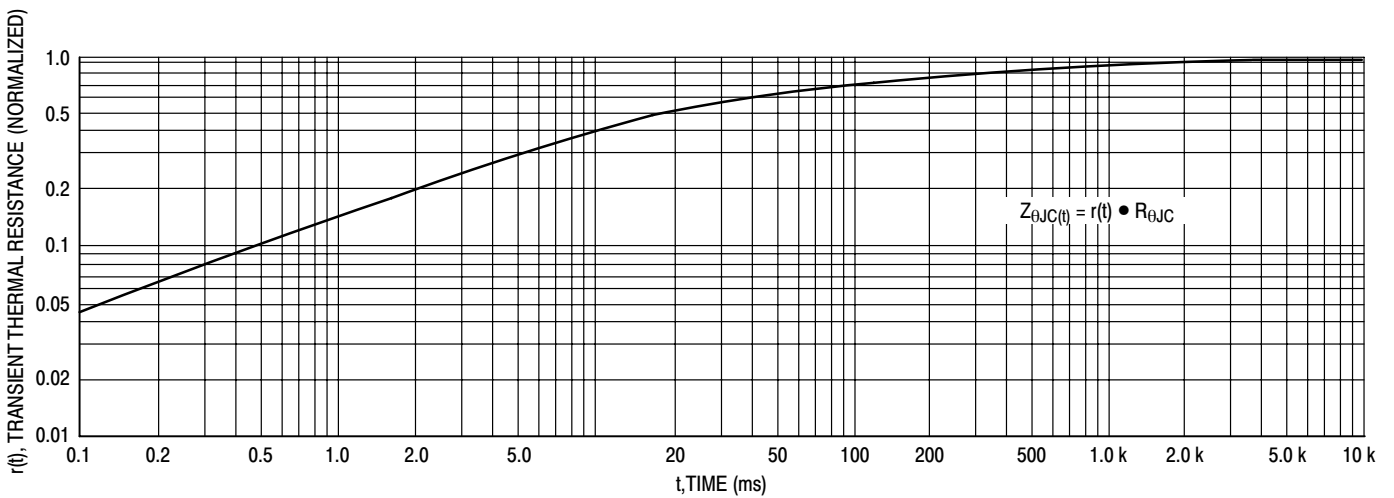
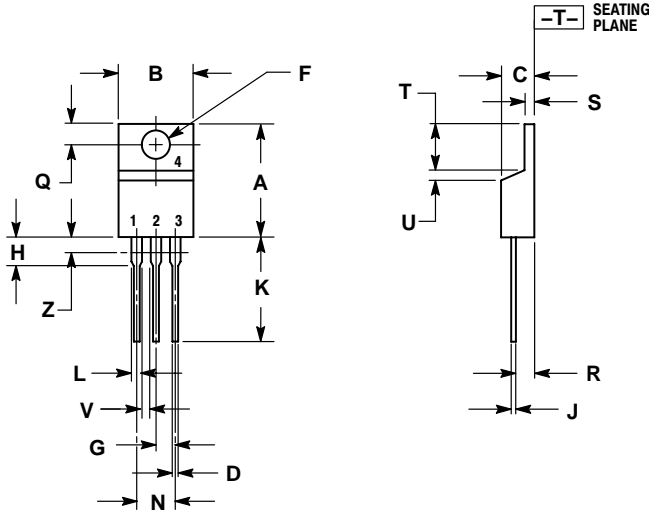

Figure 8. Typical Thermal Response

# 2N6344A, 2N6348A, 2N6349A

## PACKAGE DIMENSIONS

### TO-220AB CASE 221A-07 ISSUE AA



#### NOTES:

1. DIMENSIONING AND TOLERANCING PER ANSI Y14.5M, 1982.
2. CONTROLLING DIMENSION: INCH.
3. DIMENSION Z DEFINES A ZONE WHERE ALL BODY AND LEAD IRREGULARITIES ARE ALLOWED.

DIM	INCHES		MILLIMETERS	
	MIN	MAX	MIN	MAX
A	0.570	0.620	14.48	15.75
B	0.380	0.405	9.66	10.28
C	0.160	0.190	4.07	4.82
D	0.025	0.035	0.64	0.88
F	0.142	0.147	3.61	3.73
G	0.095	0.105	2.42	2.66
H	0.110	0.155	2.80	3.93
J	0.014	0.022	0.36	0.55
K	0.500	0.562	12.70	14.27
L	0.045	0.060	1.15	1.52
N	0.190	0.210	4.83	5.33
Q	0.100	0.120	2.54	3.04
R	0.080	0.110	2.04	2.79
S	0.045	0.055	1.15	1.39
T	0.235	0.255	5.97	6.47
U	0.000	0.050	0.00	1.27
V	0.045	---	1.15	---
Z	---	0.080	---	2.04

#### STYLE 4:

- PIN 1. MAIN TERMINAL 1
2. MAIN TERMINAL 2
3. GATE
4. MAIN TERMINAL 2

Littelfuse products are not designed for, and shall not be used for, any purpose (including, without limitation, automotive, military, aerospace, medical, life-saving, life-sustaining or nuclear facility applications, devices intended for surgical implant into the body, or any other application in which the failure or lack of desired operation of the product may result in personal injury, death, or property damage) other than those expressly set forth in applicable Littelfuse product documentation. Warranties granted by Littelfuse shall be deemed void for products used for any purpose not expressly set forth in applicable Littelfuse documentation. Littelfuse shall not be liable for any claims or damages arising out of products used in applications not expressly intended by Littelfuse as set forth in applicable Littelfuse documentation. The sale and use of Littelfuse products is subject to Littelfuse Terms and Conditions of Sale, unless otherwise agreed by Littelfuse.

Littelfuse.com