

# VJ 3505 UHF Chip Antenna for Mobile Devices

**RoHS**  
COMPLIANT

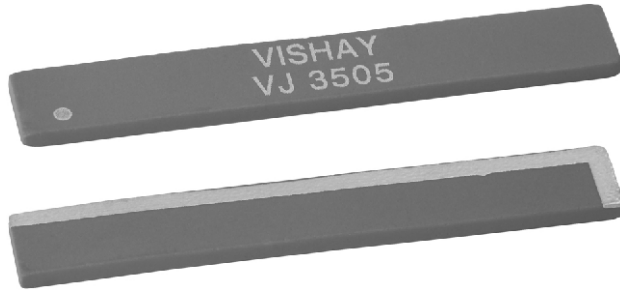

The company's products are covered by one or more of the following:

WO2008250262 (A1), US2008303720 (A1),  
US2008305750 (A1), WO2008154173 (A1).

Other patents pending.

## DESCRIPTION

The VJ 3505 multi-layer ceramic chip antenna is a small form-factor, high-performance, chip-antenna designed for TV reception in mobile devices in the UHF band. It allows mobile TV device manufacturers to design high quality products that do not bear the penalty of a large external antenna. Utilizing Vishay's unique materials and manufacturing technologies, this product complies with the MBRAI standard while maintaining a small outline.

Focusing on consumer applications, the antenna is designed to be assembled onto a PC board in the standard reflow process.

Target customers of the VJ 3505 are mobile phone makers, portable multimedia device makers, notebook OEMs and ODMs, and accessory card OEMs and ODMs.

## FEATURES

- Small outline (35 mm x 5 mm x 1.2 mm)
- Omni-directional, linear polarization
- Complies with MBRAI standard
- Complete UHF band coverage (470 MHz to 860 MHz) up to 1.1 GHz
- Requires a tuning circuit and ground plane for optimal performance
- Standard SMT assembly
- 50 Ω unbalanced interface
- Operating temperature range (-40 °C to +85 °C)
- Reference design and evaluation boards available upon request
- Material categorization: for definitions of compliance please see [www.vishay.com/doc?99912](http://www.vishay.com/doc?99912)

## APPLICATIONS

- Mobile UHF TV receivers including DVB-T, DVB-H, ISDB-T, CMMB, ATSC, and MediaFLO devices

## ANTENNA PERFORMANCE

### Peak Gain and Efficiency

The antenna radiation characteristics are influenced by several factors including ground plane dimensions and impedance matching network.

The antenna parameters presented hereafter were simulated according to the ground plane configuration suggested by the VJ 3505 evaluation board.

Fig 1. shows simulated peak gain and radiation efficiency over frequency throughout the UHF band, compared with the MBRAI requirements.

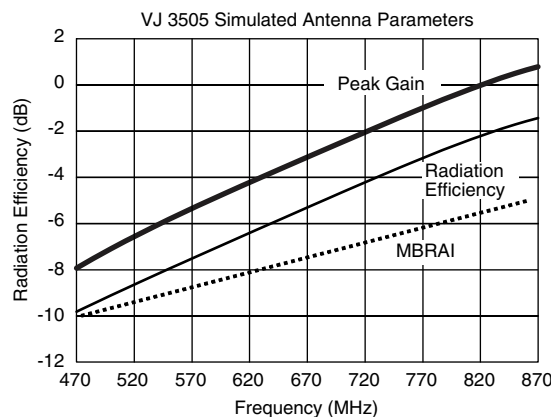

Fig. 1 - Peak Gain and Efficiency vs. Frequency

QUICK REFERENCE DATA			
SERIES	FREQUENCY (MHz)	MAX. GAIN (dBi)	AVERAGE GAIN (dBi)
VJ3505M011SXMSRA0	470 to 860	-0.5	-1

**RADIATION PATTERN**

The 3D planes of VJ 3505 are defined in Fig 2.

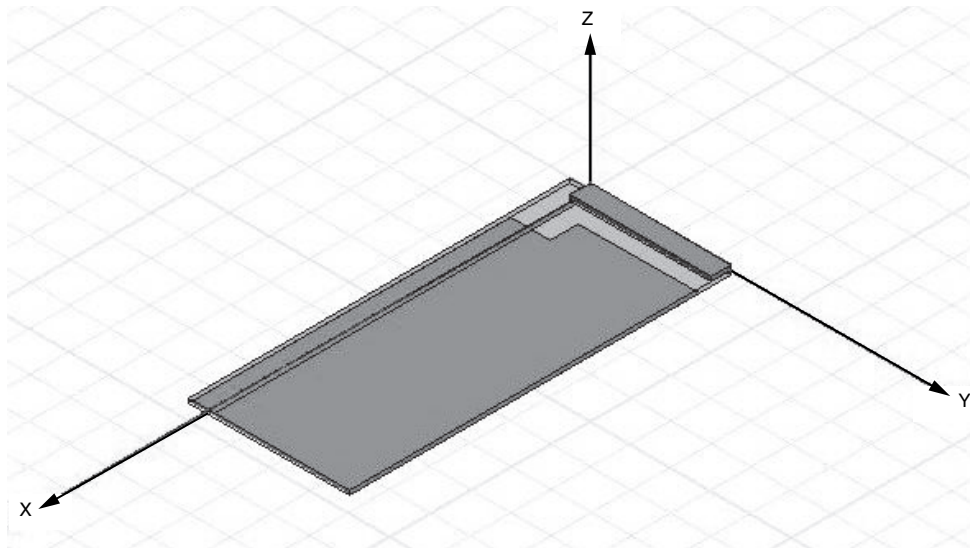

Fig. 2 - VJ 3505 3D Plane Definition

Fig 3. displays the simulated 3D radiation pattern at 550 MHz. The general pattern shape does not change with frequency.

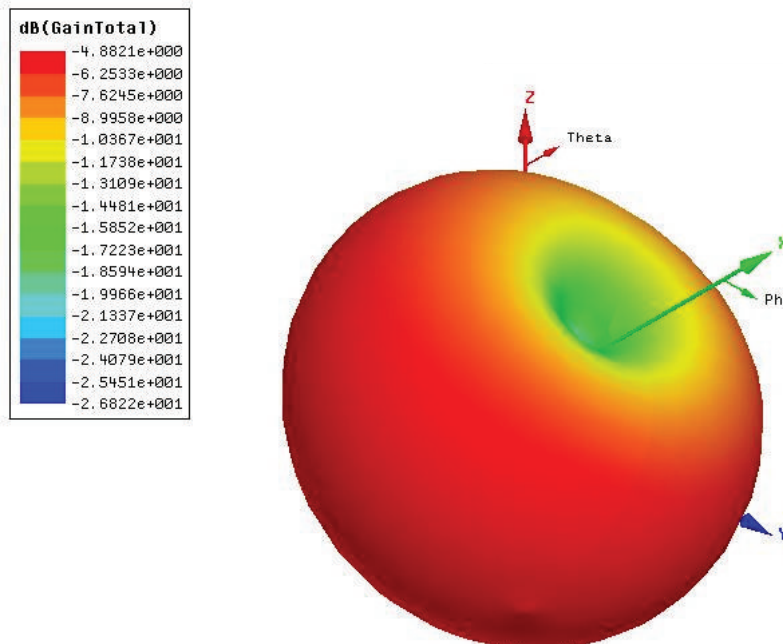

Fig. 3 - Simulated Radiation Pattern at 550 MHz

Fig. 4 displays the measured radiation patterns of VJ 3505 evaluation board in the YZ plane as defined in Fig. 2. Zero degrees is defined at the Z axis, stepping clockwise.

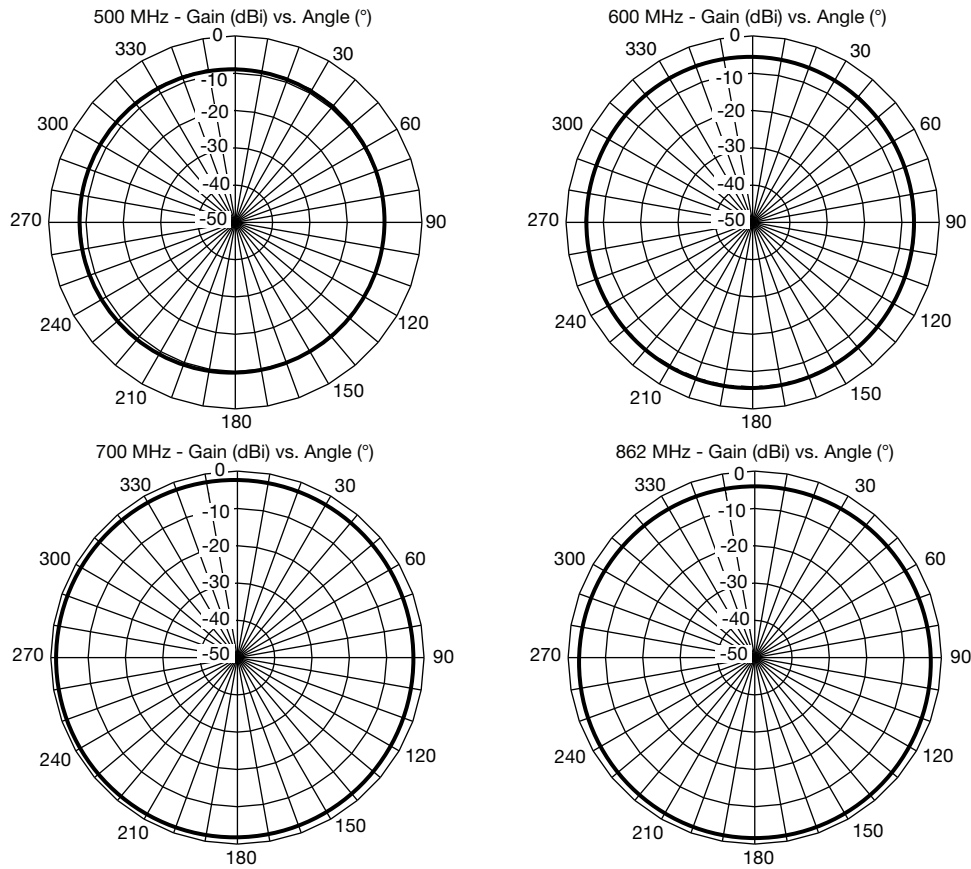

Fig. 4 - Measured Radiation Pattern

**FOOTPRINT AND MECHANICAL DIMENSIONS**

The antenna footprint and mechanical dimensions are presented in Fig 5. For mechanical support, it is recommended to add one or two drops of heat curing epoxy glue. The glue dot should not overlap with any of the soldering pads. It is recommended to apply the glue dot at the center of the antenna, as shown by the diagonal pattern. For more details see “VJ 3505 Assembly Guidelines” section below.

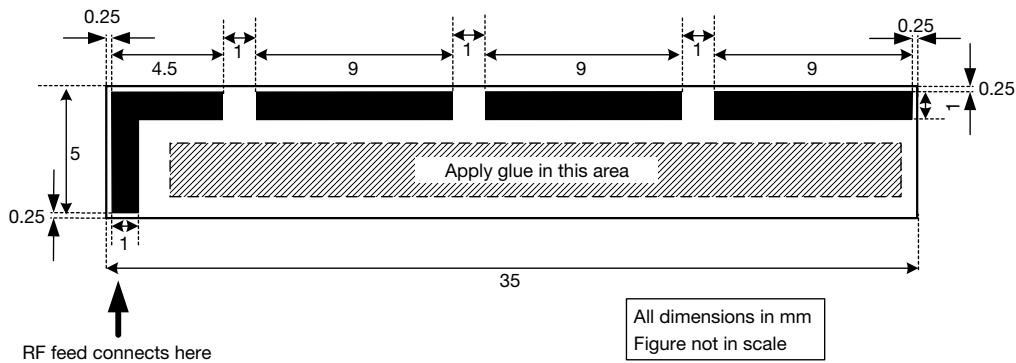

Fig. 5 - VJ 3505 Footprint

DIMENSIONS	(mm)
Length	35 + 0.5 / - 0
Width	5 + 0.5 / - 0
Height	1.2 ± 0.1

**VJ 3505 ASSEMBLY GUIDELINES**

1. Mounting of antennas on a printed circuit board should be done by reflow soldering. The reflow soldering profiles are shown below.
2. In order to provide the adequate strength between the antenna and the PCB the application of a dot of heat cured epoxy glue in the center of the footprint of the antenna prior to the antenna's soldering to the board should be done. An example for such glue could be Heraeus PD 860002 SA. The weight of the dot should be 5 mg to 10 mg.

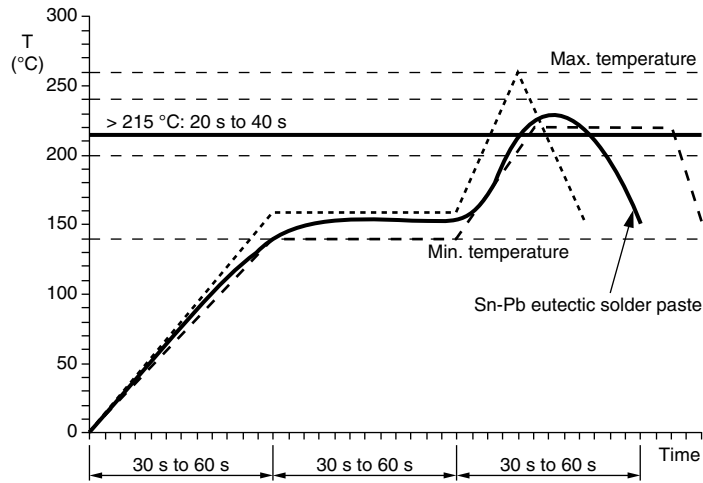

Fig. 6 - Soldering IR Reflow with SnPb Solder

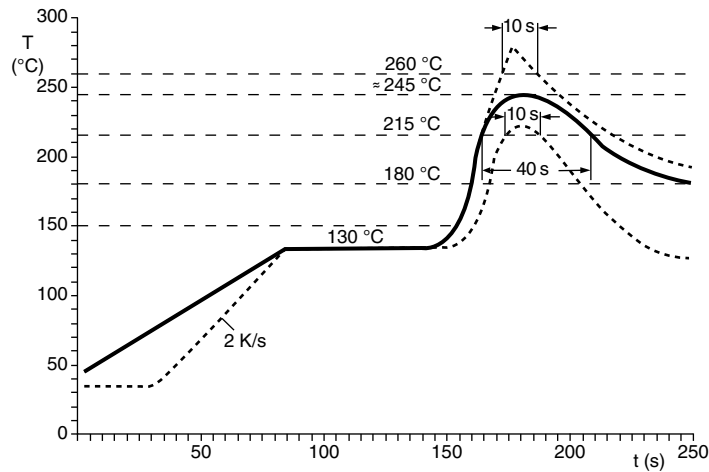

Fig. 7 - Soldering Reflow with Sn Solder

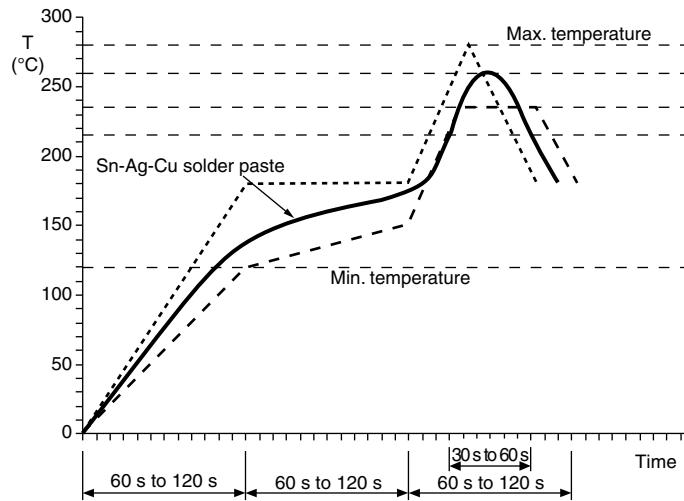

Fig. 8 - Soldering IR Reflow with SnAgCu Solder

ORDERING INFORMATION	VISHAY MATERIAL	PACKAGING QUANTITY
VJ 3505	VJ3505M011SXMSRA0	1000 pieces



## **Disclaimer**

ALL PRODUCT, PRODUCT SPECIFICATIONS AND DATA ARE SUBJECT TO CHANGE WITHOUT NOTICE TO IMPROVE RELIABILITY, FUNCTION OR DESIGN OR OTHERWISE.

Vishay Intertechnology, Inc., its affiliates, agents, and employees, and all persons acting on its or their behalf (collectively, "Vishay"), disclaim any and all liability for any errors, inaccuracies or incompleteness contained in any datasheet or in any other disclosure relating to any product.

Vishay makes no warranty, representation or guarantee regarding the suitability of the products for any particular purpose or the continuing production of any product. To the maximum extent permitted by applicable law, Vishay disclaims (i) any and all liability arising out of the application or use of any product, (ii) any and all liability, including without limitation special, consequential or incidental damages, and (iii) any and all implied warranties, including warranties of fitness for particular purpose, non-infringement and merchantability.

Statements regarding the suitability of products for certain types of applications are based on Vishay's knowledge of typical requirements that are often placed on Vishay products in generic applications. Such statements are not binding statements about the suitability of products for a particular application. It is the customer's responsibility to validate that a particular product with the properties described in the product specification is suitable for use in a particular application. Parameters provided in datasheets and / or specifications may vary in different applications and performance may vary over time. All operating parameters, including typical parameters, must be validated for each customer application by the customer's technical experts. Product specifications do not expand or otherwise modify Vishay's terms and conditions of purchase, including but not limited to the warranty expressed therein.

Except as expressly indicated in writing, Vishay products are not designed for use in medical, life-saving, or life-sustaining applications or for any other application in which the failure of the Vishay product could result in personal injury or death. Customers using or selling Vishay products not expressly indicated for use in such applications do so at their own risk. Please contact authorized Vishay personnel to obtain written terms and conditions regarding products designed for such applications.

No license, express or implied, by estoppel or otherwise, to any intellectual property rights is granted by this document or by any conduct of Vishay. Product names and markings noted herein may be trademarks of their respective owners.