



ETQP-M Series Inductor Product Guide

# Metal Composite Type Power Choke Coils

AEC-Q200 Compliant For Use  
In Harsh Environments

- Vibration Resistance of 10G ~ 30G (5Hz – 2kHz)
- Maximum Operating Temperature of 150°C
- Up to 40% Smaller 25% Lighter
- Thermal Shock -40 ~ +150°C
- Metal Composite Core



# Table of Contents

## Overview

Introduction

1

Applications

1

## Features And Benefits

High Current, High Heat Resistance And Excellent Thermal Stability

2

Acoustic Noise Reduction

3

Low Leakage Flux

3

AEC-Q200 Compliant For Use In Harsh Environments

4

Facilitates Smaller And Lighter Designs

4

Unique Terminal Structure

5

Excellent Withstanding Voltage Characteristics

5

## Comparison

Panasonic's ETQP-M Series Vs. Alternative Products

6

## Explanation of Part Numbers

Panasonic's ETQP-M Series Part Number Breakdown

7

## Selection Guide

Panasonic's ETQP-M Series Selection Guide

8

# Overview

## Introduction

Panasonic's ETQP-M Series Metal Composite Type Power Choke Coils are suited for filter, step-down and step-up circuits for DC/DC converters. They are AEC-Q200 Compliant offering reliability when exposed to high temperatures along with a high tolerance to vibration.

### DC / DC Converter Application Example

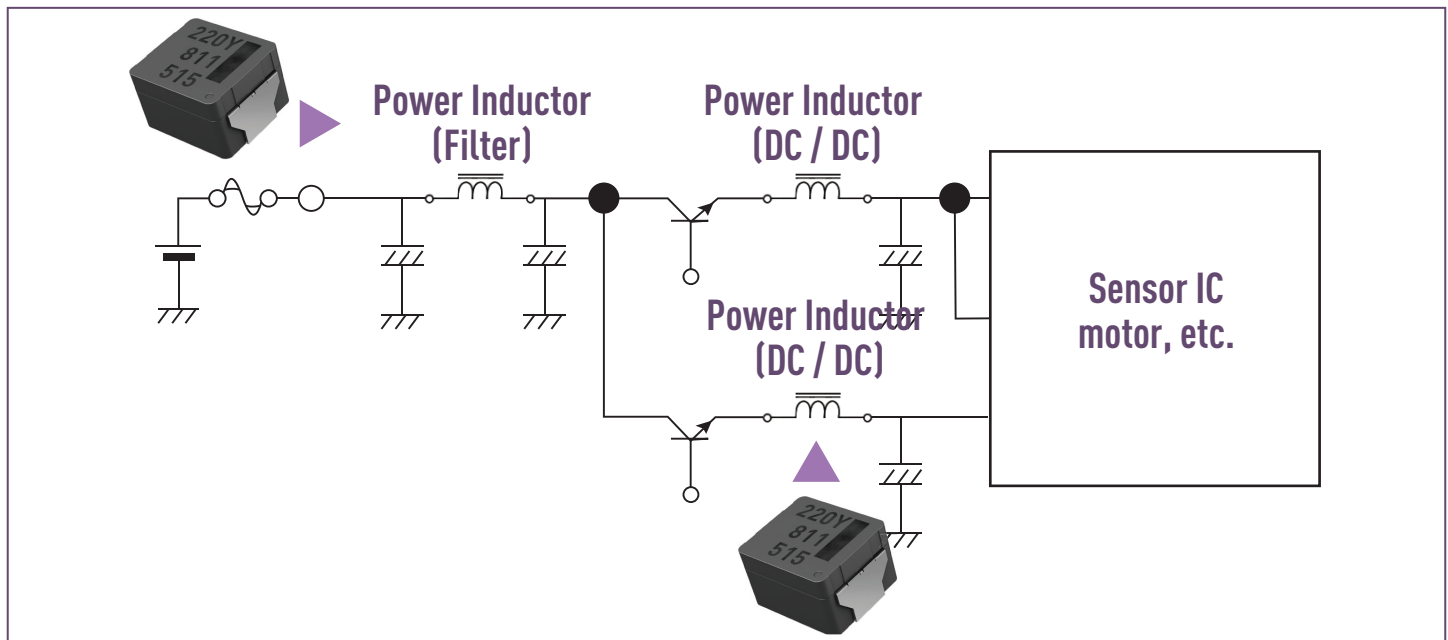

## Applications

- Noise Filter For Drive Circuits
- DC/DC Converter
- Voltage Regulator
- Buck/Boost Converters
- Server
- Router
- CPU Driver
- Notebook, Tablet
- Power Supply Module
- LED Driver

# Features And Benefits

## High Current, High Heat Resistance and Excellent Thermal Stability

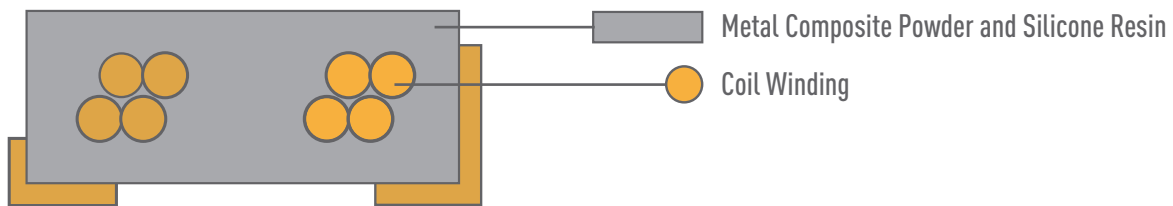

Cross-section view of an ETQP-M Power Choke Coil.

- The ETQP-M Power Inductor consists of metal powder, silicone resin and coil winding. The magnetic material, which is created from Fe-based powder, enables high current, high heat resistance and excellent thermal stability.
- Excellent magnetic saturation characteristics (i.e. Ferrite core = 0.4T vs. Metal Composite Type=above 1.5T) make it difficult to magnetically saturate, resulting in good inductance vs. current performance without substantial drop off.
- By using a high temperature capable resin material, an operating temperature up to 150°C is achievable.

### Frequency Characteristics of AC Resistance

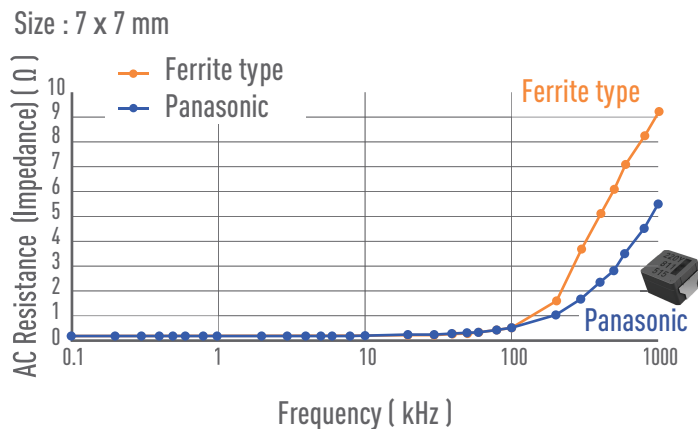

The metal composite molded structure has a distributed gap rather than a discrete gap resulting in low AC resistance (impedance) at higher frequencies.

### Effect of DC Bias Current on Inductance

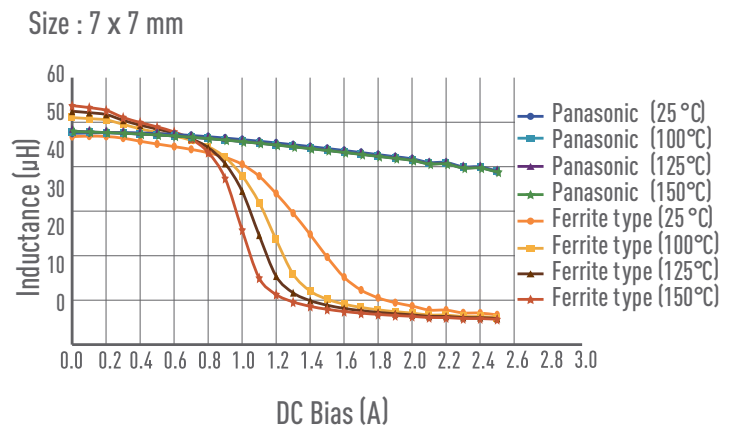

The ETQP-M Inductor allows for large currents. The inductance levels do not drop significantly as the current increases regardless of the temperature.

Comparison of Panasonic vs. Ferrite Type (At The Same Inductance (Current) Capability)

Manufacturer	Panasonic Metal Composite	Ferrite (Alternative Product)
Series	M0645	Ferrite Type
Size (mm)	6.5 × 6.0	7.4 × 6.9
Height (mm)	4.5 max	4.7 max
Volume (mm) <sup>3</sup>	187	240
Core Material	Metal Composite	Ferrite
L1 (μH) at 100kHz	47.0 (0.8A)	47.0 (0.7A)
ISAT (A) at 125°C, L-10%	1.3	0.7
DCR (mΩ)	210	158
Performance Index Per Volume	100%	60%
Max Operating Temperature	150°C	125°C

Achieved 22% downsizing

Temperature condition 125°C

## Acoustic Noise Reduction

Troublesome acoustic noise at audible frequencies is reduced by having a distributed gap structure where the resin replaces the air gap. This enables a large reduction of acoustic noise compared to Ferrite Types.

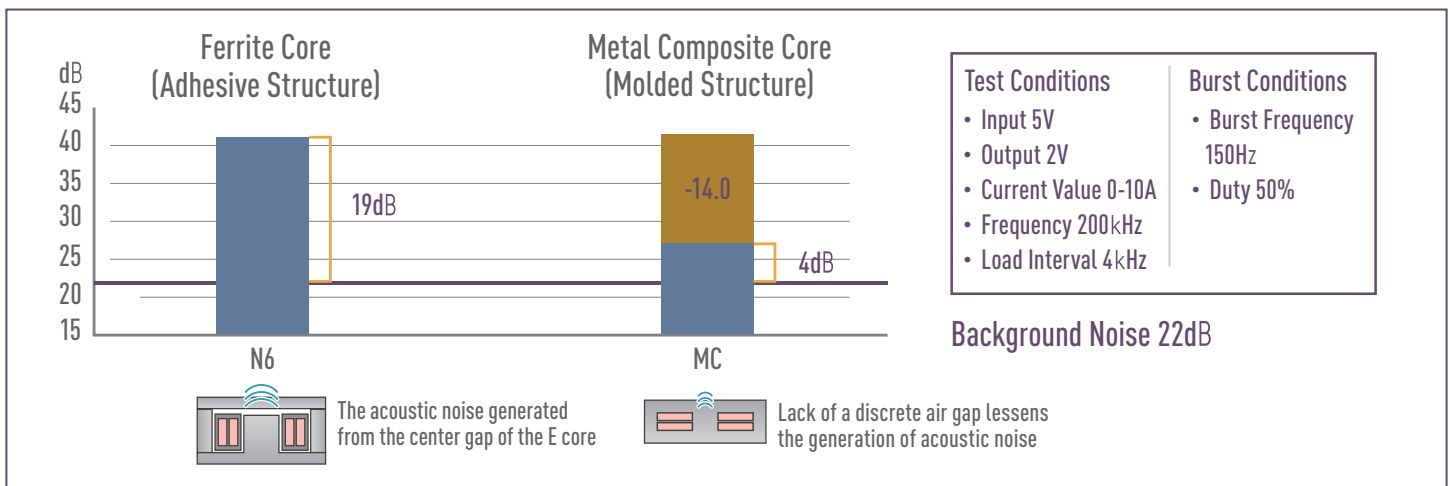

## Low Leakage Flux

The integrated molded structure of the Metal Composite Type with its distributed gap has low leakage flux from the core resulting in noise and interference reduction, facilitating high density layouts.

## AEC-Q200 Compliant For Use In Harsh Environments

Through the previously mentioned improvements, the ETQP-M Series product provides 150°C temperature (peak 180) and excellent vibration resistance characteristics.

### Reliability Results for AEC-Q200 Compliance

Item	Condition	Time	Remark
Thermal Shock	-40 ~ +150°C (Each for 10 minutes)	2000cycles	<ul style="list-style-type: none"> <li>Inductance is ±10% from initial value</li> <li>DCR is ±10% from initial value</li> <li>Insulation resistance is above 10KΩ</li> <li>Nothing abnormal on appearance and structures</li> <li>No open wire or mechanical damage</li> </ul>
Vibration Resistance	10G ~ 30G (5Hz - 2kHz)	XYZ (Each for 2 hours)	
Heat Resistance	150°C	2000 hours	
High Temperature Lifetime	150°C (Rated current applied)		
Anti-Humidity	85°C, 85%RH	2000 hours	
Anti-Humidity Lifetime Test	85°C, 85%RH (Rated current applied)		
Low Temperature Test	-40°C	2000 hours	

## Facilitates Smaller And Lighter Designs

Panasonic Metal Composite Core Types facilitate smaller designs compared with Ferrite Type Choke Coils. Around 20-40% down in size and 5-25% down in weight.

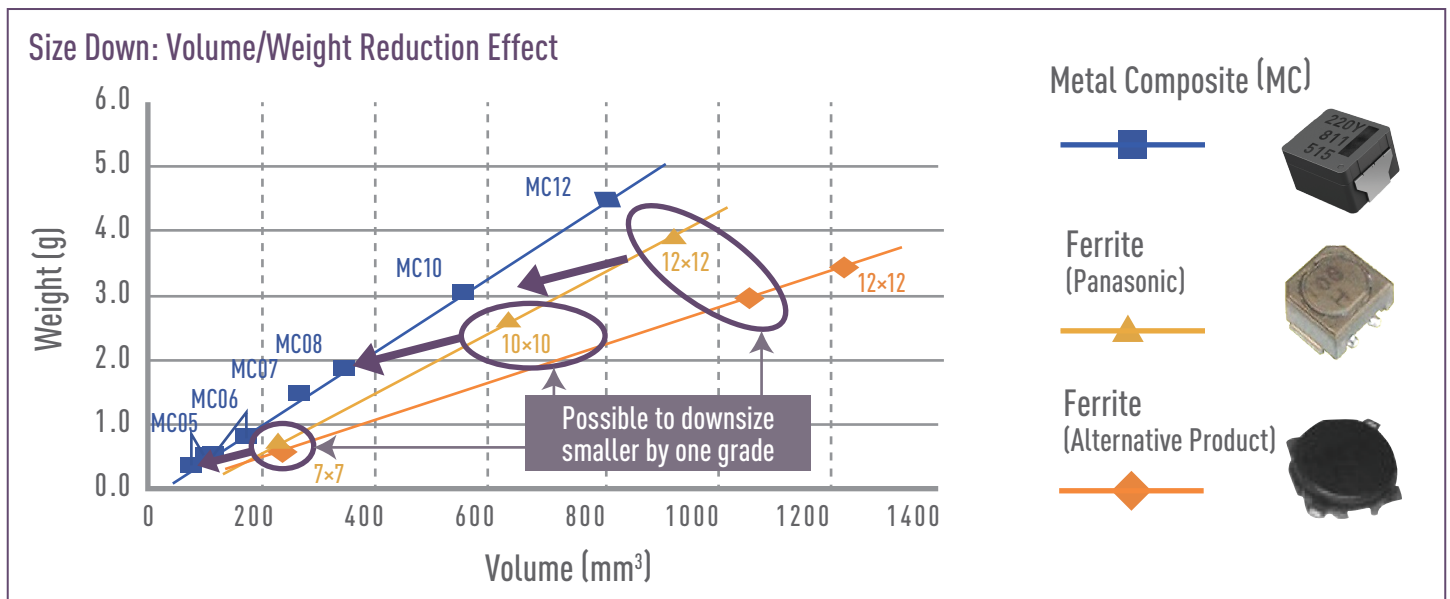

## Unique Terminal Structure

The copper wire of the internal coil is brought out directly to the terminal mounting part to ensure the reliability of mounting to the PCB. Other products make the connection inside the Metal Composite, thus it is hard to verify the connection condition and long-term reliability issues may occur with environmental stresses.

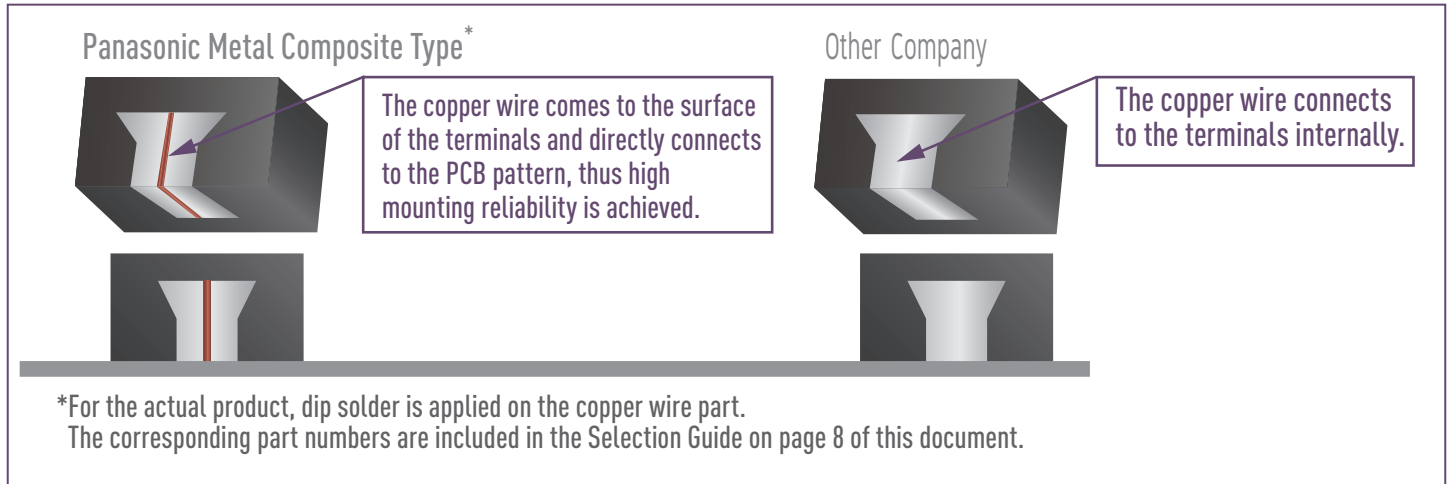

## Excellent Withstanding Voltage Characteristics

ETQP-M Series Metal Composite Type achieves excellent withstanding voltage characteristics that can be used in various applications.

Rated Voltage Table

Size mm \ Inductance $\mu$ H	0.68	1	1.5	2.2	3.3	4.7	6.8	10	15	22	33	47	68	100
10.9×10.0×6.0mm	70V			70V										
10.9×10.0×5.0mm	70V			70V										
10.7×10.0×5.4mm				70V								65V	45V	
8.5×8.0×5.4mm				60V								65V	45V	
7.5×7.0×5.4mm				50V									25V	
6.5×6.0×4.5mm				40V	35V							25V		
6.5×6.0×3.0mm	40V			35V										
5.5×5.0×4.0mm						40V	35V							
5.5×5.0×3.0mm				40V	35V									

# Comparison

## Panasonic's ETQP-M Series Vs. Alternative Products

With unique metal magnetic material technology, the ETQP-M Series displays low loss and downsizing compared with alternative products.

Panasonic Vs. Alternative Products						
Manufacturer	Panasonic		Alternative Products	Panasonic		Alternative Products
Power Inductor	8 × 8.5 × 5.4 ETQP5M220YFK	10 × 10.7 × 5.4 ETQP5M220YFC	10 × 10.7 × 4.0 22μH	8 × 8.5 × 5.4 ETQP5M470YFK	10 × 10.7 × 5.4 ETQP5M470YFC	10 × 10.7 × 4.0 47μH
Frequency	400kHz	400kHz	400kHz	400kHz	400kHz	400kHz
DCR 20°C	63mΩ	45mΩ	70mΩ	125mΩ	96mΩ	165mΩ
ACR	1190mΩ	861mΩ	1254mΩ	2416mΩ	2171mΩ	2805mΩ
Rated Current	4.33A	4.33A	4.33A	2.47A	2.47A	2.47A
I <sub>ac</sub> (Ripple)	1.11A	1.11A	1.11A	0.52A	0.52A	0.52A
I <sub>dc</sub> RMS	4.42A	4.42A	4.42A	2.51A	2.51A	2.51A
I <sub>ac</sub> RMS	0.64A	0.64A	0.64A	0.30A	0.30A	0.30A
DC Loss	1.65W	1.18W	1.83W	1.06W	0.81W	1.39W
AC Loss	0.46W	0.34W	0.52W	0.22W	0.20W	0.25W
Total Loss	2.11W	1.51W	2.35W	1.27W	1.01W	1.65W
ΔT (Top)	78.1K	49.9K	80.9K	47.1K	33.2K	56.8K
ΔT (Terminal)	58.0K	35.5K	58.6K	35.0K	23.6K	41.1K



# Explanation of Part Numbers

## Panasonic's ETQP-M Series Part Number Breakdown

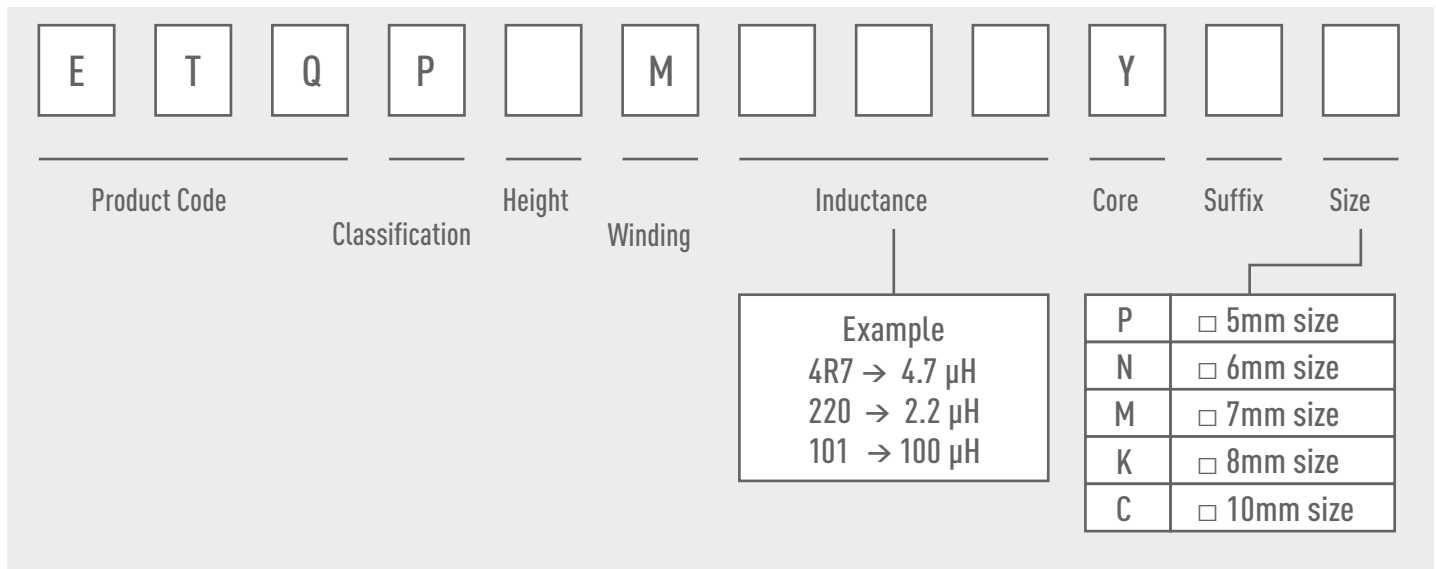

# Selection Guide

## Panasonic's ETQP-M Series Selection Guide

Panasonic's ETQP-M Series Selection Guide

Type	5x5 ETQP*MxxxYFP		6x6 ETQP*MxxxYFN		7x7 ETQP5MxxxYFM		8x8 ETQP*MxxxY*K		10x10 ETQP*MxxxY*C		10x10 (Low DCR) ETQP*MxxxYLC	
(Size) WxLxT Height=t	5.5x5.0mm t=3.0mm (<4.7μH) t=4.0mm (≥4.7μH)		6.5x6.0mm t=3.0mm (<6.8μH) t=4.5mm (≥6.8μH)		7.5x7.0mm t=5.4mm (<95μH) t=5.0mm (≥95μH)		8.5x8.0 t=5.4mm (<97μH) t=5.0mm (≥97μH)		10.7x10.0mm t=5.4mm (<95μH) t=5.0mm (≥95μH)		10.9x10.0mm t=5.0mm (<1.5μH) t=6.0mm (≥1.5μH)	
LO (μH)	Rated Current (A)	DCR (mΩ)	Rated Current (A)	DCR (mΩ)	Rated Current (A)	DCR (mΩ)	Rated Current (A)	DCR (mΩ)	Rated Current (A)	DCR (mΩ)	Rated Current (A)	DCR (mΩ)
100					1.4(*1)	348	1.7	302	2.2(*2)	208		
68									3.0(*7)	136		
47			1.8	210	2.3(*3)	156	2.9(*3)	125	3.5	99		
33					2.6	120			4.2	68.5		
22	1.9	163	2.3	126	3.0	92.0	4.1	63.0	5.2(*5)	45.0		
15							4.7	48.2				
10			3.5	54.2	4.7	37.6	5.7	33.4	7.1	23.8		
6.8			4.1	39.3	5.5	26.7						
4.7	4.0	36.0			6.3	20.4			10.9	10.2	11.8	8.7
3.3	4.0	32.3							13.1	7.1	14.2(*6)	6.0
2.2	4.8	22.6					11.9(*4)	7.6	15.1(*4)	5.3	16.3(*4)	4.55
1.5									17.9	3.8	19.6	3.2
1.0			8.8	7.9							23.0	2.3
0.68			9.8	6.3							26.3	1.75
0.33												

Note: Current value (Rated Current) is the typical value when overall temperature rise is 40k  
 (\*1) 95μH (\*2) 97μH (\*3) 48μH (\*4) 2.5μH (\*5) 21.5μH (\*6) 3.2μH (\*7) 66μH

