



## Features

- High voltage rating
- High current rating
- Bidirectional
- Surge protection
- Fast response time
- RoHS compliant\*
- Agency listing: us

## Applications

- Power supplies
- Power systems
- Line voltage
- Telecom systems
- White goods / appliances

# MOV-14DxxxK Series - Metal Oxide Varistor

### General Information

The MOV-14DxxxK Series of 14 mm radial leaded varistor devices protects against overvoltage transients such as lightning, power contact and power induction. The metal oxide varistors offer a choice of varistor voltages from 18 V to 1800 V and  $V_{rms}$  voltages from 11 V to 1100 V.

The devices have a high current handling, high energy absorption capability and fast response times to protect against transient faults up to rated limits.

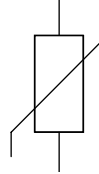

### Industry Standard Compliance

| Standard    | UL 1449 |
|-------------|---------|
| File Number | E313168 |

### Absolute Maximum Ratings (@ $T_A = 25^\circ\text{C}$ Unless Otherwise Noted)

| Parameter                                | Symbol    | Min. | Typ. | Max. | Unit                 |
|--|-----------|------|------|------|----------------------|
| Operating Temperature                    | TOPR      | -40  | 25   | +85  | $^\circ\text{C}$     |
| Storage Temperature                      | TSTG      | -40  | 25   | +125 | $^\circ\text{C}$     |
| Rated Wattage                            | $P_w$     |      |      | 0.60 | Watt                 |
| Varistor Voltage Temperature Coefficient | VTC       | 0    | 0.1  | 0.05 | % / $^\circ\text{C}$ |
| Response Time                            | $T_r$     |      | 10   | 25   | ns                   |
| Varistor Voltage Tolerance               | $V_{tol}$ | -10  | 0    | 10   | %                    |

### Electrical Characteristics (@ $T_A = 25^\circ\text{C}$ Unless Otherwise Noted)

| Bourns Part No. | Max. Continuous Voltage (V) |      | Voltage @ 1 mA DC (V) |      |      | Voltage @ Class Current (8/20 $\mu\text{s}$ ) |                           | Max. Peak Current (8/20 $\mu\text{s}$ ) | Max. Energy (J)    | Max. Cap. (pF) |
|-----------------|-----------------------------|------|-----------------------|------|------|---|---------------------------|---|--------------------|----------------|
|                 | r.m.s.                      | d.c. | Min.                  | Nom. | Max. | Class Current (A)                             | Max. Clamping Voltage (V) | One Time                                | 8/20 $\mu\text{s}$ | 1 kHz          |
|                 |                             |      |                       |      |      |   |                           |   |                    |                |
| MOV-14D180K     | 11                          | 14   | 16                    | 18   | 20   | 10  | 36                        | 1000                                    | 4.0                | 11100          |
| MOV-14D220K     | 14                          | 18   | 20                    | 22   | 24   | 10  | 43                        | 1000                                    | 5.0                | 9100           |
| MOV-14D270K     | 17                          | 22   | 24                    | 27   | 30   | 10  | 53                        | 1000                                    | 6.0                | 7400           |
| MOV-14D330K     | 20                          | 26   | 30                    | 33   | 36   | 10  | 65                        | 1000                                    | 7.5                | 6100           |
| MOV-14D390K     | 25                          | 31   | 35                    | 39   | 43   | 10  | 77                        | 1000                                    | 8.6                | 5100           |
| MOV-14D470K     | 30                          | 38   | 42                    | 47   | 52   | 10  | 93                        | 1000                                    | 10.0               | 4300           |
| MOV-14D560K     | 35                          | 45   | 50                    | 56   | 62   | 10  | 110                       | 1000                                    | 11.0               | 3600           |
| MOV-14D680K     | 40                          | 56   | 61                    | 68   | 75   | 10  | 135                       | 1000                                    | 14.0               | 2900           |
| MOV-14D820K     | 50                          | 65   | 74                    | 82   | 90   | 50  | 135                       | 4500                                    | 22.0               | 2400           |
| MOV-14D101K     | 60                          | 85   | 90                    | 100  | 110  | 50  | 165                       | 4500                                    | 28.0               | 2000           |
| MOV-14D121K     | 75                          | 100  | 108                   | 120  | 132  | 50  | 200                       | 4500                                    | 32.0               | 1700           |
| MOV-14D151K     | 95                          | 125  | 135                   | 150  | 165  | 50  | 250                       | 4500                                    | 40.0               | 1300           |
| MOV-14D181K     | 115                         | 150  | 162                   | 180  | 198  | 50  | 300                       | 4500                                    | 50.0               | 1100           |
| MOV-14D201K     | 130                         | 170  | 185                   | 200  | 225  | 50  | 340                       | 4500                                    | 57.0               | 1000           |
| MOV-14D221K     | 140                         | 180  | 198                   | 220  | 242  | 50  | 360                       | 4500                                    | 60.0               | 900            |
| MOV-14D241K     | 150                         | 200  | 216                   | 240  | 264  | 50  | 395                       | 4500                                    | 63.0               | 830            |
| MOV-14D271K     | 175                         | 225  | 243                   | 270  | 297  | 50  | 455                       | 4500                                    | 70.0               | 740            |
| MOV-14D301K     | 190                         | 250  | 270                   | 300  | 330  | 50  | 500                       | 4500                                    | 77.0               | 670            |
| MOV-14D331K     | 210                         | 275  | 297                   | 330  | 363  | 50  | 550                       | 4500                                    | 85.0               | 610            |
| MOV-14D361K     | 230                         | 300  | 324                   | 360  | 396  | 50  | 595                       | 4500                                    | 93.0               | 560            |
| MOV-14D391K     | 250                         | 320  | 351                   | 390  | 429  | 50  | 650                       | 4500                                    | 100.0              | 510            |
| MOV-14D431K     | 275                         | 350  | 387                   | 430  | 473  | 50  | 710                       | 4500                                    | 115.0              | 460            |
| MOV-14D471K     | 300                         | 385  | 423                   | 470  | 517  | 50  | 775                       | 4500                                    | 125.0              | 430            |
| MOV-14D511K     | 320                         | 415  | 459                   | 510  | 561  | 50  | 845                       | 4500                                    | 125.0              | 390            |
| MOV-14D561K     | 350                         | 460  | 504                   | 560  | 616  | 50  | 925                       | 4500                                    | 125.0              | 360            |
| MOV-14D621K     | 385                         | 505  | 558                   | 620  | 682  | 50  | 1025                      | 4500                                    | 125.0              | 320            |
| MOV-14D681K     | 420                         | 560  | 612                   | 680  | 748  | 50  | 1120                      | 4500                                    | 130.0              | 290            |
| MOV-14D751K     | 460                         | 615  | 675                   | 750  | 825  | 50  | 1240                      | 4500                                    | 143.0              | 270            |
| MOV-14D781K     | 485                         | 640  | 702                   | 780  | 858  | 50  | 1290                      | 4500                                    | 148.0              | 260            |
| MOV-14D821K     | 510                         | 670  | 738                   | 820  | 902  | 50  | 1355                      | 4500                                    | 157.0              | 240            |
| MOV-14D911K     | 550                         | 745  | 819                   | 910  | 1001 | 50  | 1500                      | 4500                                    | 175.0              | 220            |
| MOV-14D102K     | 625                         | 825  | 900                   | 1000 | 1100 | 50  | 1650                      | 4500                                    | 190.0              | 200            |
| MOV-14D112K     | 680                         | 895  | 990                   | 1100 | 1210 | 50  | 1815                      | 4500                                    | 213.0              | 180            |
| MOV-14D152K     | 940                         | 1200 | 1350                  | 1500 | 1650 | 50  | 2475                      | 4500                                    | 329.0              | 150            |
| MOV-14D182K     | 1100                        | 1465 | 1620                  | 1800 | 1980 | 50  | 2970                      | 4500                                    | 335.0              | 100            |

\*RoHS Directive 2002/95/EC Jan. 27, 2003 including annex and RoHS Recast 2011/65/EU June 8, 2011.

Specifications are subject to change without notice.

The device characteristics and parameters in this data sheet can and do vary in different applications and actual device performance may vary over time. Users should verify actual device performance in their specific applications.

# MOV-14DxxxK Series - Metal Oxide Varistor

**BOURNS®**

## Product Dimensions

This is an RoHS compliant molded radial package with 100 % Sn plating on the terminations.

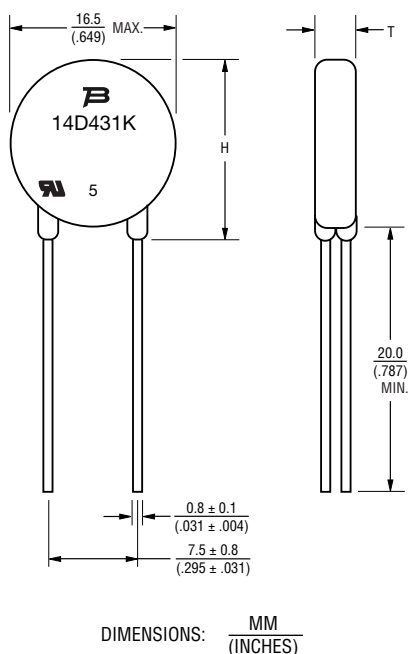

| Part Number | Dim. H (Max.)         | Dim. T (Max.)        |
|-------------|-----------------------|----------------------|
| MOV-14D180K | $\frac{20.0}{(.787)}$ | $\frac{3.8}{(.150)}$ |
| MOV-14D220K | $\frac{20.0}{(.787)}$ | $\frac{3.9}{(.154)}$ |
| MOV-14D270K | $\frac{20.0}{(.787)}$ | $\frac{4.2}{(.165)}$ |
| MOV-14D330K | $\frac{20.0}{(.787)}$ | $\frac{3.8}{(.150)}$ |
| MOV-14D390K | $\frac{20.0}{(.787)}$ | $\frac{4.0}{(.157)}$ |
| MOV-14D470K | $\frac{20.0}{(.787)}$ | $\frac{4.2}{(.165)}$ |
| MOV-14D560K | $\frac{20.0}{(.787)}$ | $\frac{4.3}{(.169)}$ |
| MOV-14D680K | $\frac{20.0}{(.787)}$ | $\frac{4.4}{(.173)}$ |
| MOV-14D820K | $\frac{20.0}{(.787)}$ | $\frac{3.8}{(.150)}$ |
| MOV-14D101K | $\frac{20.0}{(.787)}$ | $\frac{4.0}{(.157)}$ |
| MOV-14D121K | $\frac{20.0}{(.787)}$ | $\frac{4.2}{(.165)}$ |
| MOV-14D151K | $\frac{20.0}{(.787)}$ | $\frac{4.4}{(.173)}$ |
| MOV-14D181K | $\frac{20.0}{(.787)}$ | $\frac{3.6}{(.142)}$ |
| MOV-14D201K | $\frac{20.0}{(.787)}$ | $\frac{3.8}{(.150)}$ |
| MOV-14D221K | $\frac{20.0}{(.787)}$ | $\frac{3.9}{(.154)}$ |
| MOV-14D241K | $\frac{20.0}{(.787)}$ | $\frac{4.0}{(.157)}$ |
| MOV-14D271K | $\frac{20.0}{(.787)}$ | $\frac{4.2}{(.165)}$ |
| MOV-14D301K | $\frac{20.0}{(.787)}$ | $\frac{4.4}{(.173)}$ |

| Part Number  | Dim. H (Max.)         | Dim. T (Max.)         |
|--------------|-----------------------|-----------------------|
| MOV-14D331K  | $\frac{20.0}{(.787)}$ | $\frac{4.6}{(.181)}$  |
| MOV-14D361K  | $\frac{20.0}{(.787)}$ | $\frac{4.8}{(.189)}$  |
| MOV-14D391K  | $\frac{20.0}{(.787)}$ | $\frac{5.0}{(.197)}$  |
| MOV-14D431K  | $\frac{20.0}{(.787)}$ | $\frac{5.2}{(.205)}$  |
| MOV-14D471K  | $\frac{20.0}{(.787)}$ | $\frac{5.4}{(.213)}$  |
| MOV-14D511K  | $\frac{20.0}{(.787)}$ | $\frac{5.5}{(.217)}$  |
| MOV-14D561K  | $\frac{22.0}{(.866)}$ | $\frac{6.0}{(.236)}$  |
| MOV-14D621K  | $\frac{22.0}{(.866)}$ | $\frac{6.4}{(.252)}$  |
| MOV-14D681K  | $\frac{22.0}{(.866)}$ | $\frac{6.5}{(.256)}$  |
| MOV-14D751K  | $\frac{22.0}{(.866)}$ | $\frac{6.7}{(.264)}$  |
| MOV-14D781K  | $\frac{22.0}{(.866)}$ | $\frac{6.9}{(.272)}$  |
| MOV-14D821K  | $\frac{22.0}{(.866)}$ | $\frac{7.3}{(.287)}$  |
| MOV-14D911K* | $\frac{22.0}{(.866)}$ | $\frac{7.7}{(.303)}$  |
| MOV-14D102K* | $\frac{22.0}{(.866)}$ | $\frac{8.2}{(.323)}$  |
| MOV-14D112K* | $\frac{22.0}{(.866)}$ | $\frac{8.7}{(.343)}$  |
| MOV-14D152K* | $\frac{22.0}{(.866)}$ | $\frac{9.7}{(.382)}$  |
| MOV-14D182K* | $\frac{22.0}{(.866)}$ | $\frac{11.7}{(.461)}$ |

\* Not available in Tape & Reel packaging.

## How to Order

### MOV - 14D nn (n) K (TR)

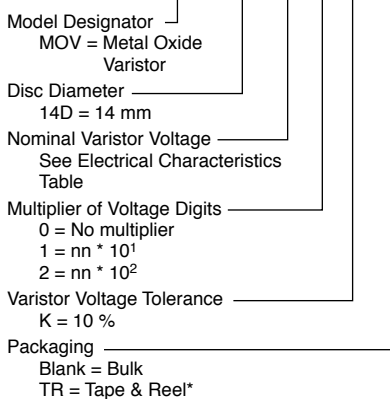

Examples: MOV-14D270K = 27 V, Bulk Pack  
MOV-14D331KTR = 330 V, Tape & Reel

\* Models MOV-14D911K, 102K, 112K, 152K and 182K are not available in Tape & Reel packaging.

## Internal Construction

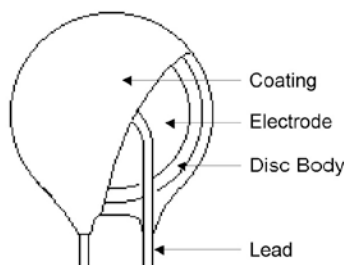

Specifications are subject to change without notice. The device characteristics and parameters in this data sheet can and do vary in different applications and actual device performance may vary over time. Users should verify actual device performance in their specific applications.

# MOV-14DxxxK Series - Metal Oxide Varistor



## Performance Graphs

### V-I Characteristics

MOV-14D180K to MOV-14D680K

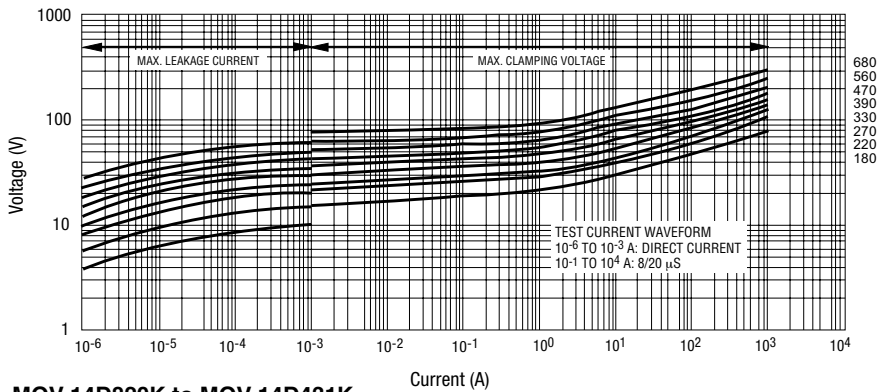

MOV-14D820K to MOV-14D431K

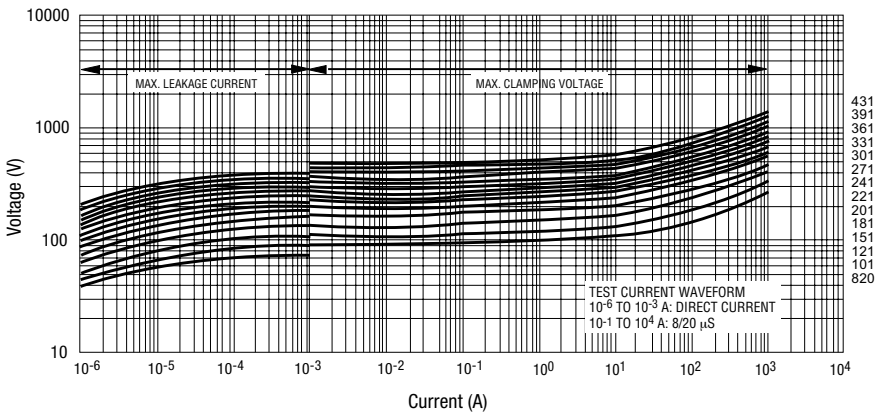

MOV-14D471K to MOV-14D182K

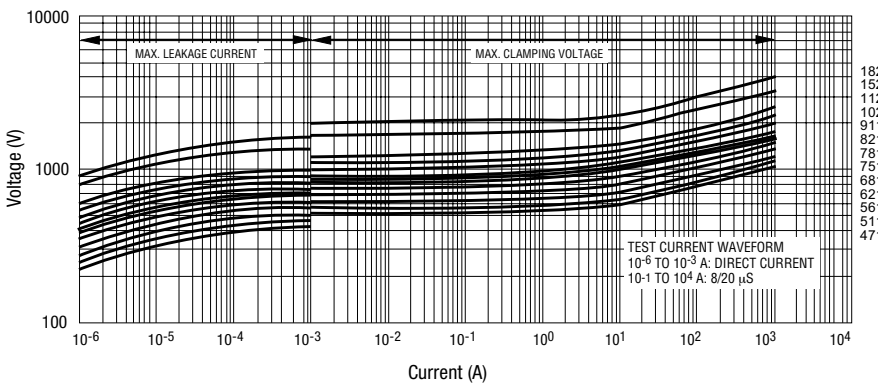

## Typical Part Marking

| Bourns Part Number | Bourns Part Marking |
|--------------------|---------------------|
| MOV-14D180K        | 14D180K             |
| MOV-14D220K        | 14D220K             |
| MOV-14D270K        | 14D270K             |
| MOV-14D330K        | 14D330K             |
| MOV-14D390K        | 14D390K             |
| MOV-14D470K        | 14D470K             |
| MOV-14D560K        | 14D560K             |
| MOV-14D680K        | 14D680K             |
| MOV-14D820K        | 14D820K             |
| MOV-14D101K        | 14D101K             |
| MOV-14D121K        | 14D121K             |
| MOV-14D151K        | 14D151K             |
| MOV-14D181K        | 14D181K             |
| MOV-14D201K        | 14D201K             |
| MOV-14D221K        | 14D221K             |
| MOV-14D241K        | 14D241K             |
| MOV-14D271K        | 14D271K             |
| MOV-14D301K        | 14D301K             |
| MOV-14D331K        | 14D331K             |
| MOV-14D361K        | 14D361K             |
| MOV-14D391K        | 14D391K             |
| MOV-14D431K        | 14D431K             |
| MOV-14D471K        | 14D471K             |
| MOV-14D511K        | 14D511K             |
| MOV-14D561K        | 14D561K             |
| MOV-14D621K        | 14D621K             |
| MOV-14D681K        | 14D681K             |
| MOV-14D751K        | 14D751K             |
| MOV-14D781K        | 14D781K             |
| MOV-14D821K        | 14D821K             |
| MOV-14D911K        | 14D911K             |
| MOV-14D102K        | 14D102K             |
| MOV-14D112K        | 14D112K             |
| MOV-14D152K        | 14D152K             |
| MOV-14D182K        | 14D182K             |

NOTE: The "5" marking on MOV products is for traceability of production assembly for quality assurance compliance.

Specifications are subject to change without notice. The device characteristics and parameters in this data sheet can and do vary in different applications and actual device performance may vary over time. Users should verify actual device performance in their specific applications.

# MOV-14DxxxK Series - Metal Oxide Varistor

# BOURNS®

## Packaging Information

### TAPE & REEL

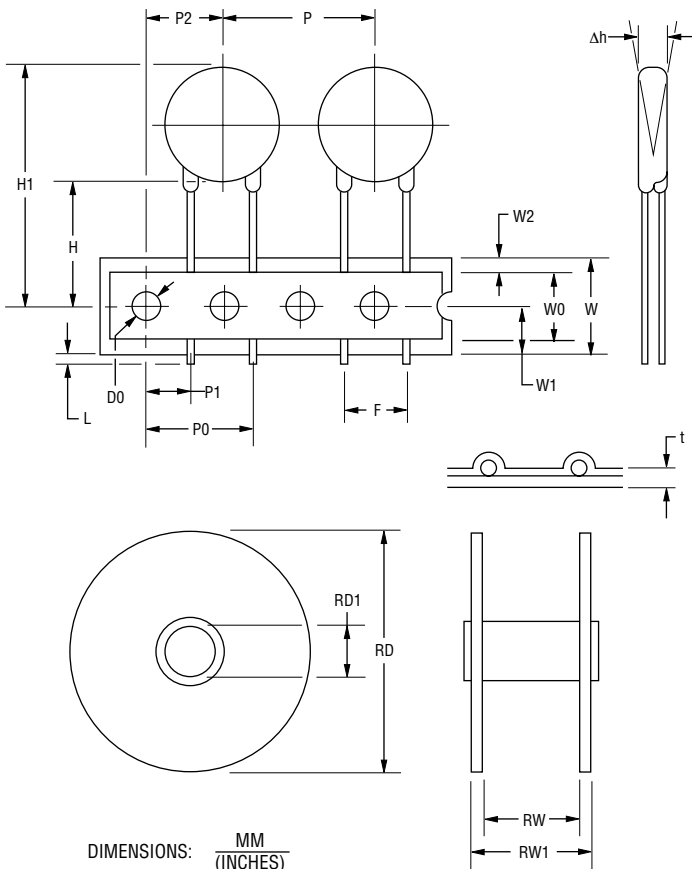

DIMENSIONS:  $\frac{\text{MM}}{\text{(INCHES)}}$

NOTE: Models MOV-14D911K, 102K, 112K, 152K and 182K are not available in Tape & Reel packaging.

| Item                                 | Symbol     | 14 mm Disc                             |
|--------------------------------------|------------|--|
| Reel Outside Diameter                | RD         | $\frac{355}{(13.98)}$                  |
| Reel Inner Diameter                  | RD1        | $\frac{30}{(11.81)}$                   |
| Tape Width                           | RW         | $\frac{55}{(2.165)}$                   |
| Reel Width                           | RW1        | $\frac{63}{(2.48)}$                    |
| Pitch of Component                   | P          | $\frac{25.4 \pm 1.0}{(1.00 \pm 0.04)}$ |
| Feed Hole Pitch                      | P0         | $\frac{12.7 \pm 1.0}{(0.50 \pm 0.04)}$ |
| Feed Hole Center to Pitch            | P1         | $\frac{8.95 \pm 0.7}{(0.352 \pm 0.3)}$ |
| Feed Hole Center to Component Center | P2         | $\frac{12.7 \pm 1.0}{(0.50 \pm 0.04)}$ |
| Lead to Lead Distance                | F          | $\frac{7.50 \pm 0.8}{(0.30 \pm 0.03)}$ |
| Component Alignment                  | $\Delta h$ | $\frac{4.0}{(0.157)}$ max.             |
| Tape Width                           | W          | $\frac{18.0 \pm 0.5}{(0.71 \pm 0.02)}$ |
| Hole Down Tape Width                 | W0         | $\frac{12.0 \pm 0.8}{(0.47 \pm 0.03)}$ |
| Hole Position                        | W1         | $\frac{9.0 \pm 0.5}{(0.35 \pm 0.02)}$  |
| Hole Down Tape Position              | W2         | $\frac{3.0}{(0.12)}$ max.              |
| Height From Center to Component Base | H          | $\frac{19.0 \pm 1.0}{(0.75 \pm 0.04)}$ |
| Seating Plane Height                 | H0         | $\frac{16.0 \pm 0.5}{(0.63 \pm 0.02)}$ |
| Component Height                     | H1         | $\frac{40.0}{(1.57)}$ max.             |
| Crimp Length                         | C          | $\frac{2.60}{(0.10)}$ typ.             |
| Feed Hole Diameter                   | D0         | $\frac{4.0 \pm 0.2}{(0.16 \pm 0.08)}$  |
| Total Tape Thickness                 | t          | $\frac{0.6 \pm 0.3}{(0.02 \pm 0.01)}$  |
| Length of Clipped Height             | L          | $\frac{1.0}{(0.04)}$ max.              |
| Quantity per Reel                    | -          | 1000                                   |
| MOV-14D180K - 14D391K                | -          | 500                                    |
| MOV-14D431K - 14D821K                | -          |  |

### BULK

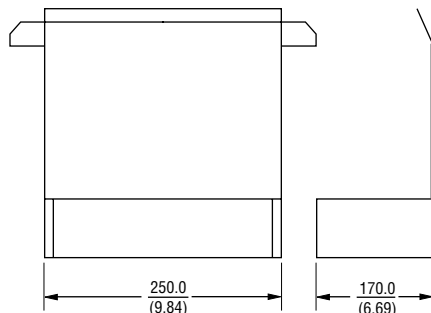

#### QUANTITY:

MOV-14D180K - MOV14D391K = 1000 PCS. PER BOX  
 MOV-14D431K - MOV14D182K = 500 PCS. PER BOX

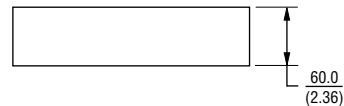

REV. 02/17

Specifications are subject to change without notice.

The device characteristics and parameters in this data sheet can and do vary in different applications and actual device performance may vary over time. Users should verify actual device performance in their specific applications.