



Is Now Part of



**ON Semiconductor®**

To learn more about ON Semiconductor, please visit our website at  
[www.onsemi.com](http://www.onsemi.com)

ON Semiconductor and the ON Semiconductor logo are trademarks of Semiconductor Components Industries, LLC dba ON Semiconductor or its subsidiaries in the United States and/or other countries. ON Semiconductor owns the rights to a number of patents, trademarks, copyrights, trade secrets, and other intellectual property. A listing of ON Semiconductor's product/patent coverage may be accessed at [www.onsemi.com/site/pdf/Patent-Marking.pdf](http://www.onsemi.com/site/pdf/Patent-Marking.pdf). ON Semiconductor reserves the right to make changes without further notice to any products herein. ON Semiconductor makes no warranty, representation or guarantee regarding the suitability of its products for any particular purpose, nor does ON Semiconductor assume any liability arising out of the application or use of any product or circuit, and specifically disclaims any and all liability, including without limitation special, consequential or incidental damages. Buyer is responsible for its products and applications using ON Semiconductor products, including compliance with all laws, regulations and safety requirements or standards, regardless of any support or applications information provided by ON Semiconductor. "Typical" parameters which may be provided in ON Semiconductor data sheets and/or specifications can and do vary in different applications and actual performance may vary over time. All operating parameters, including "Typicals" must be validated for each customer application by customer's technical experts. ON Semiconductor does not convey any license under its patent rights nor the rights of others. ON Semiconductor products are not designed, intended, or authorized for use as a critical component in life support systems or any FDA Class 3 medical devices or medical devices with a same or similar classification in a foreign jurisdiction or any devices intended for implantation in the human body. Should Buyer purchase or use ON Semiconductor products for any such unintended or unauthorized application, Buyer shall indemnify and hold ON Semiconductor and its officers, employees, subsidiaries, affiliates, and distributors harmless against all claims, costs, damages, and expenses, and reasonable attorney fees arising out of, directly or indirectly, any claim of personal injury or death associated with such unintended or unauthorized use, even if such claim alleges that ON Semiconductor was negligent regarding the design or manufacture of the part. ON Semiconductor is an Equal Opportunity/Affirmative Action Employer. This literature is subject to all applicable copyright laws and is not for resale in any manner.



# USB1T20 — Universal Serial Bus Transceiver

## Features

- Complies with Universal Serial Bus Specification 2.0 for FS/LS Applications
- Utilizes Digital Inputs and Outputs to Transmit and Receive USB Cable Data
- Supports 12Mbit/s Full Speed (FS) and 1.5Mbit/s Low Speed (LS) Serial Data Transmission
- Supports Single-ended and Differential Data Interface as Function of MODE
- Single 3.3 V Supply
- ESD Performance: Human Body Model
  - 9.5 kV on D-, D+ Pins Only
  - 4.0 kV on All Other Pins

## Description

USB1T20 is a generic USB 2.0 compliant transceiver. Using a single voltage supply, the USB1T20 provides an ideal USB interface solution for any electronic device able to supply 3.0 V to 3.6 V. It is designed to allow 5.0 V or 3.3 V programmable and standard logic to interface with the physical layer of the Universal Serial Bus (USB). It is capable of transmitting and receiving serial data at both full speed (12Mbit/s) and low speed (1.5Mbit/s) data rates.

Packaged in industry-standard TSSOP package. The USB1T20 is ideal for mobile electronics and other space-constrained applications.

## Ordering Information

Part Number	Operating Temperature Range	Package	Packing Method
USB1T20MTCX	-40° to +85°C	14-Lead, Thin-Shrink Small-Outline Package (TSSOP) JEDEC MO-153, 4.4mm Wide	Tape and Reel

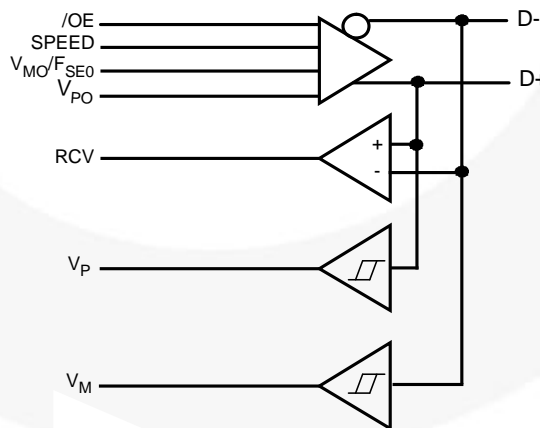

Figure 1. Logic Diagram

## Pin Configuration

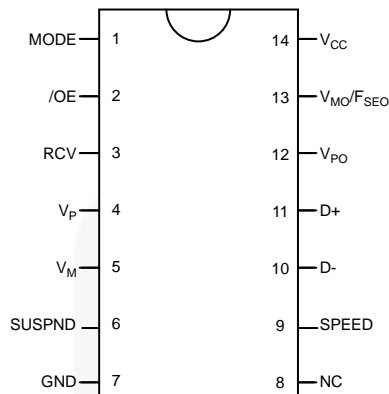

Figure 2. Pin Configuration (Top View)

## Pin Definitions

Pin #	Name	I/O	Description			
1	MODE	I	<b>Mode.</b> When left unconnected, a weak pull-up transistor pulls mode pin to $V_{CC}$ and, in this GND, the $V_{MO}/F_{SEO}$ pin takes the function of $F_{SEO}$ (force SEO).			
2	/OE	I	<b>Output Enable.</b> Active LOW; enables the transceiver to transmit data on the bus. When not active, the transceiver is in receive mode.			
3	RCV	O	<b>Receive Data.</b> CMOS-Level output for USB differential input.			
4, 5	$V_P, V_M$	O	Gated version of D- and D+. Outputs are logic "0" and logic "1." Used to detect single ended zero (/SEO), error conditions, and interconnected speed. (Input to SIE).			
			<b><math>V_P</math></b>	<b><math>V_M</math></b>	<b>RESULT</b>	
			0	0	/SEO	
			0	1	Low Speed	
			1	0	Full Speed	
6	SUSPND	I	<b>Suspend.</b> Enables a low-power state while the USB bus is inactive. While the suspend pin is active, it drives the RCV pin to a logic "0" state. Both D+ and D- are 3-state.			
7	GND		Ground reference.			
8	NC		No connect.			
9	SPEED	I	<b>Edge Rate Control.</b> Logic "1" operates at edge rates for full speed. Logic "0" operates edge rates for low speed.			
10, 11	D-, D+	AI/O	Data+, Data-. Differential data bus conforming to the Universal Serial Bus standard.			
12, 13	$V_{PO}, V_{MO}/F_{SEO}$	I	Inputs to differential driver. (Outputs from SIE.)			
			<b>Mode</b>	<b><math>V_{PO}</math></b>	<b><math>V_{MO}/F_{SEO}</math></b>	<b>RESULT</b>
			0	0	0	Logic "0"
				0	1	/SEO
				1	0	Logic "1"
				1	1	/SEO
			1	0	0	/SEO
				0	1	Logic "0"
				1	0	Logic "1"
1	1	1	Illegal Code			
14	$V_{CC}$		3.0 to 3.6 power supply.			

### Functional Truth Table

Input					I/O		Outputs			
Mode	V <sub>PO</sub>	V <sub>MO</sub> /F <sub>SEO</sub>	/OE	SUSPND	D+	D-	RCV	V <sub>P</sub>	V <sub>M</sub>	Result
0	0	0	0	0	0	1	0	0	1	Logic "0"
0	0	1	0	0	0	0	Undefined State	0	0	/SEO
0	1	0	0	0	1	0	1	1	0	Logic "1"
0	1	1	0	0	0	0	Undefined State	0	0	/SEO
1	0	0	0	0	0	0	Undefined State	0	0	/SEO
1	0	1	0	0	0	1	0	0	1	Logic "0"
1	1	0	0	0	1	0	1	1	0	Logic "1"
1	1	1	0	0	1	1	Undefined State	Undefined State	Undefined State	Illegal Code
Don't Care	Don't Care	Don't Care	1	0	3-State	3-State	Undefined State	Undefined State	Undefined State	D+/D-Hi-Z
Don't Care	Don't Care	Don't Care	1	1	3-State	3-State	Undefined State	Undefined State	Undefined State	D+/D-Hi-Z

## Absolute Maximum Ratings

Stresses exceeding the absolute maximum ratings may damage the device. The device may not function or be operable above the recommended operating conditions and stressing the parts to these levels is not recommended. In addition, extended exposure to stresses above the recommended operating conditions may affect device reliability. The absolute maximum ratings are stress ratings only.

Symbol	Parameter	Min.	Max.	Unit	
$V_{CC}$	DC Supply Voltage	-0.5	7.0	V	
$I_{IK}$	DC Input Diode Current, $V_{IN} < 0$ V		-50	mA	
$V_{IN}$	Input Voltage <sup>(1)</sup>	-0.5	5.5	V	
$V_{I/O}$	Input / Output Voltage	-0.5	$V_{CC} + 0.5$	V	
$I_{OK}$	Output Diode Current, $V_O > V_{CC}$ or $V_O < 0$ V		$\pm 50$	mA	
$V_O$	Output Voltage <sup>(1)</sup>	-0.5	$V_{CC} + 0.5$	V	
$I_O$	Output Source or Sink Current ( $V_O = 0$ to $V_{CC}$ )	$V_P, V_M, RCV$ Pins		$\pm 15$	mA
		D+/D- Pins		$\pm 50$	
$I_{CC} / I_{GND}$	$V_{CC} / GND$ Current		$\pm 100$	mA	
$T_{STG}$	Storage Temperature Range	-60	+150	°C	

### Note:

- The input and output negative voltage ratings may be exceeded if the input and output diode current ratings are observed.

## Recommended Operating Conditions

The Recommended Operating Conditions table defines the conditions for actual device operation. Recommended operating conditions are specified to ensure optimal performance to the datasheet specifications. Fairchild does not recommend exceeding them or designing to Absolute Maximum Ratings.

Symbol	Parameter	Min.	Max.	Unit
$V_{CC}$	Supply Voltage	3.0	3.6	V
$V_{IN}$	Input Voltage	0	5.5	V
$V_{AI/O}$	Input Range for AI/O	0	$V_{CC}$	V
$V_O$	Output Voltage	0	$V_{CC}$	V
$T_A$	Operating Ambient Temperature, Free Air	-40	+85	°C

## DC Electrical Characteristics Digital Pins

Over the recommended range of supply voltage and operating free air temperature unless otherwise noted.  $V_{CC} = 3.0\text{ V to }3.6\text{ V}$ .

Symbol	Parameter	Conditions	$T_A = -40\text{ to }+85^\circ\text{C}$			Units
			Min.	Typ.	Max.	
<b>Input Levels</b>						
$V_{IL}$	Low-Level Input Voltage				0.8	V
$V_{IH}$	High-Level Input Voltage		2			V
<b>Output Levels</b>						
$V_{OL}$	Low-Level Output Voltage	$I_{OL} = 4\text{ mA}$			0.4	V
		$I_{OL} = 20\text{ }\mu\text{A}$			0.1	
$V_{OH}$	High-Level Output Voltage	$I_{OH} = 4\text{ mA}$	2.4			V
		$I_{OH} = 20\text{ }\mu\text{A}$	$V_{CC}-0.1$			
<b>Leakage Current</b>						
$I_{IN}$	Input Leakage Current	$V_{CC} = 3.0\text{ to }3.6\text{ V}$			$\pm 5$	$\mu\text{A}$
$I_{CCFS}$	Supply Current, Full Speed	$V_{CC} = 3.0\text{ to }3.6\text{ V}$			5	mA
$I_{CCLS}$	Supply Current, Low Speed	$V_{CC} = 3.0\text{ to }3.6\text{ V}$			5	mA
$I_{CCQ}$	Quiescent Supply Current	$V_{CC} = 3.0\text{ to }3.6\text{ V}$ , $V_{IN} = V_{CC}\text{ or GND}$			5	mA
$I_{CCS}$	Supply Current in Suspend	$V_{CC} = 3.0\text{ to }3.6\text{ V}$ , Mode = $V_{CC}$			10	$\mu\text{A}$

## DC Electrical Characteristics D+/D- Pins

Over the recommended range of supply voltage and operating free air temperature unless otherwise noted.  $V_{CC} = 3.0\text{ V to }3.6\text{ V}$ .

Symbol	Parameter	Conditions	$T_A = -40\text{ to }+85^\circ\text{C}$			Units
			Min.	Typ.	Max.	
<b>Input Levels</b>						
$V_{DI}$	Differential Input Sensitivity	$ (D+) - (D-) $	0.2			V
$V_{CM}$	Differential Common-Mode Range	Includes $V_{DI}$ Range	0.8		2.5	V
$V_{SE}$	Single-Ended Receiver Threshold		0.8		2.0	V
<b>Output Levels</b>						
$V_{OL}$	Static Output Low-Voltage	$R_L$ of $1.5\text{ k}\Omega$ to $3.6\text{ V}$			0.3	V
$V_{OH}$	Static Output High-Voltage	$R_L$ of $1.5\text{ k}\Omega$ to GND	2.8		3.6	V
$V_{CR}$	Differential Crossover		1.3		2.0	V
<b>Leakage Current</b>						
$I_{OZ}$	High-Z State Data Line Leakage Current	$0\text{ V} < V_{IN} < 3.3\text{ V}$			$\pm 5$	$\mu\text{A}$
<b>Capacitance</b>						
$C_{IN}$	Transceiver Capacitance <sup>(2)</sup>	Pin to GND			10	pF
	Capacitance Match <sup>(2)</sup>				10	%
<b>Output Resistance</b>						
$Z_{DRV}$	Driver Output Resistance <sup>(3)</sup>	Steady-State Drive	4		20	$\Omega$
	Resistance Match <sup>(3)</sup>				10	%

### Notes:

- This specification is guaranteed by design and statistical process distribution.
- Excludes external resistor. To comply with USB specification 1.1, external series resistors of  $24\text{ }\Omega \pm 1\%$  each on D+ and D- are recommended.

## AC Electrical Characteristics D+/D- Pins, Full Speed

Over the recommended range of supply voltage and operating free air temperature unless otherwise noted.  
 $V_{CC} = 3.0\text{ V to }3.6\text{ V}$ ;  $C_L = 50\text{ pF}$ ;  $R_L = 1.5\text{ k}\Omega$  on D+ to  $V_{CC}$ .

Symbol	Parameter	Conditions	$T_A = -40\text{ to }+85^\circ\text{C}$			Units
			Min.	Typ.	Max.	
<b>Driver Characteristics</b>						
$t_R, t_F$	Rise and Fall Time	10 and 90%, Figure 3	4		20	ns
$t_{RFM}$	Rise/Fall Time Matching	$t_r / t_f$	90		110	%
$V_{CRS}$	Output Signal Crossover Voltage		1.3		2.0	V
<b>Driver Timings</b>						
$t_{PLH}$	Driver Propagation Delay ( $V_{PO}, V_{MO}/F_{SEO}$ to D+/D-)	Figure 4			18	ns
$t_{PHZ}, t_{PLZ}$	Driver Disable Delay (/OE to D+/D-)	Figure 6			13	ns
$t_{PZH}, t_{PZL}$	Driver Enable Delay (/OE to D+/D-)	Figure 6			17	ns
<b>Receiver Timings</b>						
$t_{PLH}$	Receiver Propagation Delay D+/D- to RVC	Figure 5			16	ns
$t_{PHL}$					19	ns
$t_{PLH}, t_{PHL}$	Single-ended Receiver Delay (D+, D- to $V_P, V_M$ )	Figure 5			8	ns

## AC Electrical Characteristics D+/D- Pins, Low Speed

Over the recommended range of supply voltage and operating free air temperature unless otherwise noted.  
 $V_{CC} = 3.0\text{ V to }3.6\text{ V}$ ;  $C_L = 200\text{ pF to }600\text{ pF}$ ;  $R_L = 1.5\text{ k}\Omega$  on D- to  $V_{CC}$ .

Symbol	Parameter	Conditions	$T_A = -40\text{ to }+85^\circ\text{C}$			Units
			Min.	Typ.	Max.	
<b>Driver Characteristics</b>						
$t_{LR}, t_{LF}$	Rise and Fall Time	10 and 90%, Figure 3	75		300	ns
$t_{RFM}$	Rise/Fall Time Matching	$t_r / t_f$	80		120	%
$V_{CRS}$	Output Signal Crossover Voltage		1.3		2.0	V
<b>Driver Timings</b>						
$t_{PLH}, t_{PHL}$	Driver Propagation Delay ( $V_{PO}, V_{MO}/F_{SEO}$ to D+/D-)	Figure 4			300	ns
$t_{PHZ}, t_{PLZ}$	Driver Disable Delay (/OE to D+/D-)	Figure 6			13	ns
$t_{PZH}, t_{PZL}$	Driver Enable Delay (/OE to D+/D-)	Figure 6			205	ns
<b>Receiver Timings</b>						
$t_{PLH}, t_{PHL}$	Receiver Propagation Delay (D+/D- to RVC)	Figure 5			18	ns
$t_{PLH}, t_{PHL}$	Single-ended Receiver Delay (D+, D- to $V_P, V_M$ )	Figure 5			28	ns

### AC Loadings and Waveforms

$V_{OL}$  and  $V_{OH}$  are the typical output voltage drops that occur with the output load.  $V_{CC}$  never goes below 3.0 V.

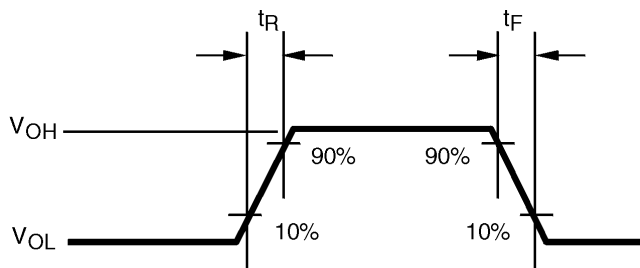

Figure 3. Rise and Fall Times

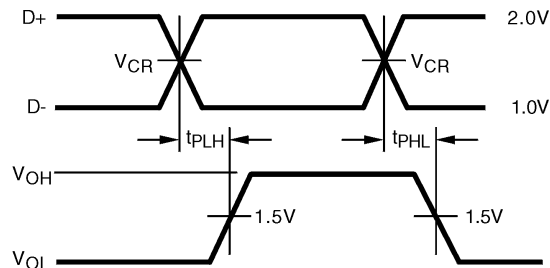

Figure 4.  $V_{PO}$ ,  $V_{MO}/F_{SEO}$  to D+/D-

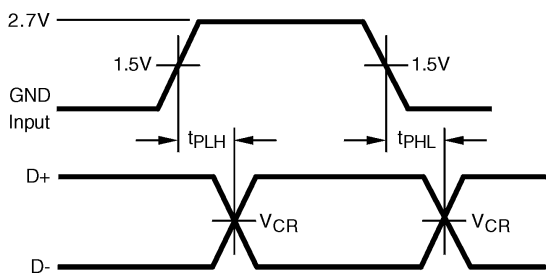

Figure 5. D+/D- to RCV,  $V_F/V_M$

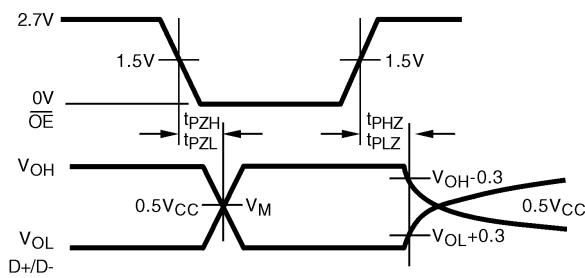

Figure 6. /OE to D+/D-

### Test Circuits and Waveforms

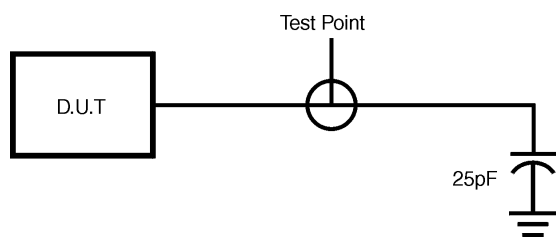

Figure 7. Load for  $V_M/V_P$  and RCV

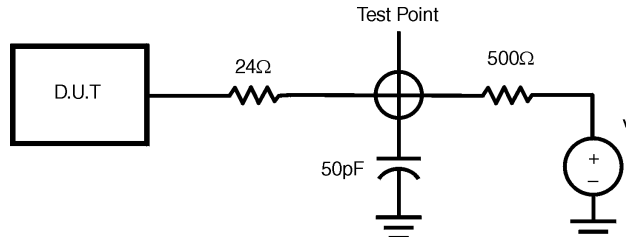
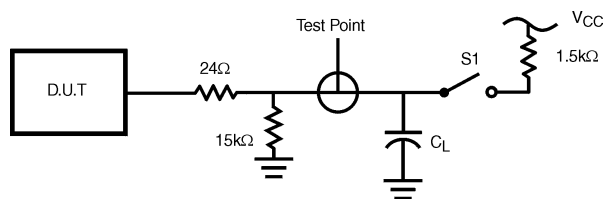

Figure 8. Load for Enable and Disable Times



Test	S1
D-/LS	Close
D+/LS	Open
D-/FS	Open
D+/FS	Close

$C_L=50\text{pF}$ , Full Speed  
 $C_L=200\text{pF}$ , Low Speed (Minimum Timing)  
 $C_L=600\text{pF}$ , Low Speed (Maximum Timing)  
 1.5kΩ on D- (Low Speed) or D+ (Full Speed) only

Figure 9. Load for D+/D-





**NOTES:**

- A. CONFORMS TO JEDEC REGISTRATION MO-153, VARIATION AB, REF NOTE 6
- B. DIMENSIONS ARE IN MILLIMETERS.
- C. DIMENSIONS ARE EXCLUSIVE OF BURRS, MOLD FLASH, AND TIE BAR EXTRUSIONS
- D. DIMENSIONING AND TOLERANCES PER ANSI Y14.5M, 2009.
- E. LANDPATTERN STANDARD: SOP65P640X110-14M.
- F. DRAWING FILE NAME: MKT-MTC14rev7.



ON Semiconductor and  are trademarks of Semiconductor Components Industries, LLC dba ON Semiconductor or its subsidiaries in the United States and/or other countries. ON Semiconductor owns the rights to a number of patents, trademarks, copyrights, trade secrets, and other intellectual property. A listing of ON Semiconductor's product/patent coverage may be accessed at [www.onsemi.com/site/pdf/Patent-Marking.pdf](http://www.onsemi.com/site/pdf/Patent-Marking.pdf). ON Semiconductor reserves the right to make changes without further notice to any products herein. ON Semiconductor makes no warranty, representation or guarantee regarding the suitability of its products for any particular purpose, nor does ON Semiconductor assume any liability arising out of the application or use of any product or circuit, and specifically disclaims any and all liability, including without limitation special, consequential or incidental damages. Buyer is responsible for its products and applications using ON Semiconductor products, including compliance with all laws, regulations and safety requirements or standards, regardless of any support or applications information provided by ON Semiconductor. "Typical" parameters which may be provided in ON Semiconductor data sheets and/or specifications can and do vary in different applications and actual performance may vary over time. All operating parameters, including "Typicals" must be validated for each customer application by customer's technical experts. ON Semiconductor does not convey any license under its patent rights nor the rights of others. ON Semiconductor products are not designed, intended, or authorized for use as a critical component in life support systems or any FDA Class 3 medical devices or medical devices with a same or similar classification in a foreign jurisdiction or any devices intended for implantation in the human body. Should Buyer purchase or use ON Semiconductor products for any such unintended or unauthorized application, Buyer shall indemnify and hold ON Semiconductor and its officers, employees, subsidiaries, affiliates, and distributors harmless against all claims, costs, damages, and expenses, and reasonable attorney fees arising out of, directly or indirectly, any claim of personal injury or death associated with such unintended or unauthorized use, even if such claim alleges that ON Semiconductor was negligent regarding the design or manufacture of the part. ON Semiconductor is an Equal Opportunity/Affirmative Action Employer. This literature is subject to all applicable copyright laws and is not for resale in any manner.

## PUBLICATION ORDERING INFORMATION

### LITERATURE FULFILLMENT:

Literature Distribution Center for ON Semiconductor  
19521 E. 32nd Pkwy, Aurora, Colorado 80011 USA  
**Phone:** 303-675-2175 or 800-344-3860 Toll Free USA/Canada  
**Fax:** 303-675-2176 or 800-344-3867 Toll Free USA/Canada  
**Email:** [orderlit@onsemi.com](mailto:orderlit@onsemi.com)

**N. American Technical Support:** 800-282-9855 Toll Free  
USA/Canada  
**Europe, Middle East and Africa Technical Support:**  
Phone: 421 33 790 2910  
**Japan Customer Focus Center**  
Phone: 81-3-5817-1050

**ON Semiconductor Website:** [www.onsemi.com](http://www.onsemi.com)  
**Order Literature:** <http://www.onsemi.com/orderlit>  
For additional information, please contact your local  
Sales Representative