



Is Now Part of



ON Semiconductor®

To learn more about ON Semiconductor, please visit our website at
www.onsemi.com

ON Semiconductor and the ON Semiconductor logo are trademarks of Semiconductor Components Industries, LLC dba ON Semiconductor or its subsidiaries in the United States and/or other countries. ON Semiconductor owns the rights to a number of patents, trademarks, copyrights, trade secrets, and other intellectual property. A listing of ON Semiconductor's product/patent coverage may be accessed at www.onsemi.com/site/pdf/Patent-Marking.pdf. ON Semiconductor reserves the right to make changes without further notice to any products herein. ON Semiconductor makes no warranty, representation or guarantee regarding the suitability of its products for any particular purpose, nor does ON Semiconductor assume any liability arising out of the application or use of any product or circuit, and specifically disclaims any and all liability, including without limitation special, consequential or incidental damages. Buyer is responsible for its products and applications using ON Semiconductor products, including compliance with all laws, regulations and safety requirements or standards, regardless of any support or applications information provided by ON Semiconductor. "Typical" parameters which may be provided in ON Semiconductor data sheets and/or specifications can and do vary in different applications and actual performance may vary over time. All operating parameters, including "Typicals" must be validated for each customer application by customer's technical experts. ON Semiconductor does not convey any license under its patent rights nor the rights of others. ON Semiconductor products are not designed, intended, or authorized for use as a critical component in life support systems or any FDA Class 3 medical devices or medical devices with a same or similar classification in a foreign jurisdiction or any devices intended for implantation in the human body. Should Buyer purchase or use ON Semiconductor products for any such unintended or unauthorized application, Buyer shall indemnify and hold ON Semiconductor and its officers, employees, subsidiaries, affiliates, and distributors harmless against all claims, costs, damages, and expenses, and reasonable attorney fees arising out of, directly or indirectly, any claim of personal injury or death associated with such unintended or unauthorized use, even if such claim alleges that ON Semiconductor was negligent regarding the design or manufacture of the part. ON Semiconductor is an Equal Opportunity/Affirmative Action Employer. This literature is subject to all applicable copyright laws and is not for resale in any manner.

BS270 N-Channel Enhancement Mode Field Effect Transistor

General Description

These N-Channel enhancement mode field effect transistors are produced using Fairchild's proprietary, high cell density, DMOS technology. These products have been designed to minimize on-state resistance while provide rugged, reliable, and fast switching performance. They can be used in most applications requiring up to 500mA DC. These products are particularly suited for low voltage, low current applications such as small servo motor control, power MOSFET gate drivers, and other switching applications.

Features

- 400mA, 60V. $R_{DS(ON)} = 2\Omega @ V_{GS} = 10V$.
- High density cell design for low $R_{DS(ON)}$.
- Voltage controlled small signal switch.
- Rugged and reliable.
- High saturation current capability.

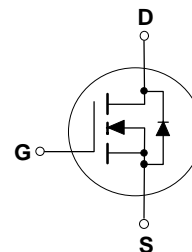
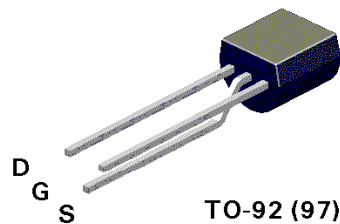

Absolute Maximum Ratings $T_A = 25^\circ\text{C}$ unless otherwise noted

| Symbol | Parameter | BS270 | Units |
|----------------|---|------------|----------------------|
| V_{DSS} | Drain-Source Voltage | 60 | V |
| V_{DGR} | Drain-Gate Voltage ($R_{GS} \leq 1M\Omega$) | 60 | V |
| V_{GSS} | Gate-Source Voltage - Continuous - Non Repetitive ($t_p < 50\mu\text{s}$) | ± 20 | V |
| | | ± 40 | |
| I_D | Drain Current - Continuous - Pulsed | 400 | mA |
| | | 2000 | |
| P_D | Maximum Power Dissipation Derate Above 25°C | 625 | mW |
| | | 5 | mW/ $^\circ\text{C}$ |
| T_J, T_{STG} | Operating and Storage Temperature Range | -55 to 150 | $^\circ\text{C}$ |
| T_L | Maximum Lead Temperature for Soldering Purposes, 1/16" from Case for 10 Seconds | 300 | $^\circ\text{C}$ |

THERMAL CHARACTERISTICS

| | | | |
|-----------------|---|-----|--------------------|
| $R_{\theta JA}$ | Thermal Resistacne, Junction-to-Ambient | 200 | $^\circ\text{C/W}$ |
|-----------------|---|-----|--------------------|

Electrical Characteristics ($T_A = 25^\circ\text{C}$ unless otherwise noted)

| Symbol | Parameter | Conditions | Min | Typ | Max | Units |
|---|---|---|---|------|-------|---------------|
| OFF CHARACTERISTICS | | | | | | |
| BV_{DSS} | Drain-Source Breakdown Voltage | $V_{GS} = 0\text{ V}, I_D = 10\ \mu\text{A}$ | 60 | | | V |
| I_{DSS} | Zero Gate Voltage Drain Current | $V_{DS} = 60\text{ V}, V_{GS} = 0\text{ V}$ $T_J = 125^\circ\text{C}$ | | | 1 | μA |
| | | | | | 500 | μA |
| I_{GSSF} | Gate - Body Leakage, Forward | $V_{GS} = 20\text{ V}, V_{DS} = 0\text{ V}$ | | | 10 | nA |
| I_{GSSF} | Gate - Body Leakage, Reverse | $V_{GS} = -20\text{ V}, V_{DS} = 0\text{ V}$ | | | -10 | nA |
| ON CHARACTERISTICS (Note 1) | | | | | | |
| $V_{GS(th)}$ | Gate Threshold Voltage | $V_{DS} = V_{GS}, I_D = 250\ \mu\text{A}$ | 1 | 2.1 | 2.5 | V |
| $R_{DS(on)}$ | Static Drain-Source On-Resistance | $V_{GS} = 10\text{ V}, I_D = 500\text{ mA}$ $T_J = 125^\circ\text{C}$ | | 1.2 | 2 | Ω |
| | | | $V_{GS} = 4.5\text{ V}, I_D = 75\text{ mA}$ | | 1.8 | 3 |
| $V_{DS(on)}$ | Drain-Source On-Voltage | $V_{GS} = 10\text{ V}, I_D = 500\text{ mA}$ $V_{GS} = 4.5\text{ V}, I_D = 75\text{ mA}$ | | 0.6 | 1 | V |
| | | | | 0.14 | 0.225 | |
| $I_{D(on)}$ | On-State Drain Current | $V_{GS} = 10\text{ V}, V_{DS} \geq 2 V_{DS(on)}$ $V_{GS} = 4.5\text{ V}, V_{DS} \geq 2 V_{DS(on)}$ | 2000 | 2700 | | mA |
| | | | 400 | 600 | | |
| g_{FS} | Forward Transconductance | $V_{DS} \geq 2 V_{DS(on)}, I_D = 200\text{ mA}$ | 100 | 320 | | mS |
| DYNAMIC CHARACTERISTICS | | | | | | |
| C_{iss} | Input Capacitance | $V_{DS} = 25\text{ V}, V_{GS} = 0\text{ V},$ $f = 1.0\text{ MHz}$ | | 20 | 50 | pF |
| C_{oss} | Output Capacitance | | | 11 | 25 | pF |
| C_{rss} | Reverse Transfer Capacitance | | | 4 | 5 | pF |
| SWITCHING CHARACTERISTICS (Note 1) | | | | | | |
| t_{on} | Turn-On Time | $V_{DD} = 30\text{ V}, I_D = 500\text{ mA},$ $V_{GS} = 10\text{ V}, R_{GEN} = 25\ \Omega$ | | | 10 | ns |
| t_{off} | Turn-Off Time | | | | 10 | ns |
| DRAIN-SOURCE DIODE CHARACTERISTICS AND MAXIMUM RATINGS | | | | | | |
| I_S | Maximum Continuous Drain-Source Diode Forward Current | | | 400 | | mA |
| I_{SM} | Maximum Pulsed Drain-Source Diode Forward Current | | | 2000 | | mA |
| V_{SD} | Drain-Source Diode Forward Voltage | $V_{GS} = 0\text{ V}, I_S = 400\text{ mA}$ (Note 1) | | 0.88 | 1.2 | V |

Note:

 1. Pulse Test: Pulse Width $\leq 300\ \mu\text{s}$, Duty Cycle $\leq 2.0\%$.

Typical Electrical Characteristics

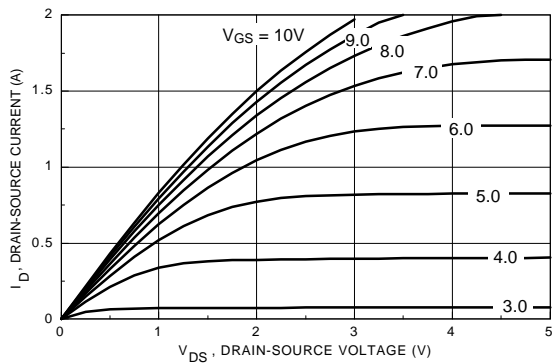

Figure 1. On-Region Characteristics.

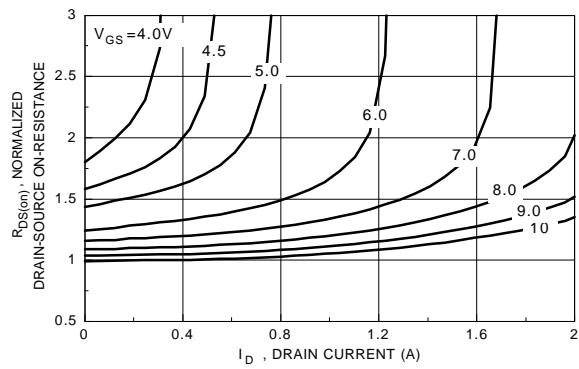

Figure 2. On-Resistance Variation with Gate Voltage and Drain Current.

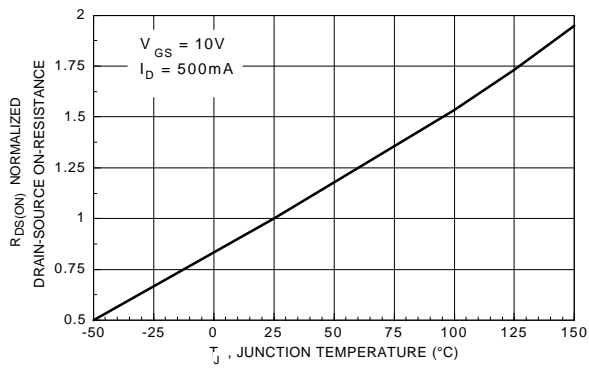

Figure 3. On-Resistance Variation with Temperature.

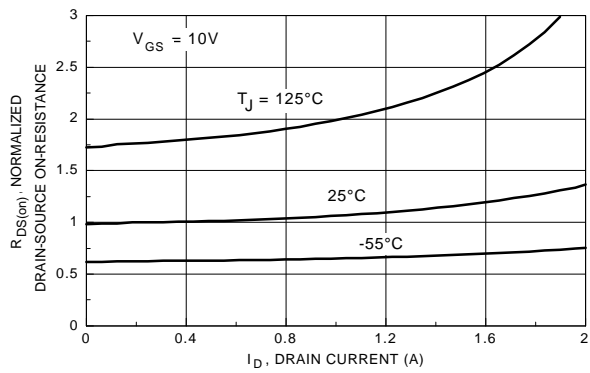

Figure 4. On-Resistance Variation with Drain Current and Temperature.

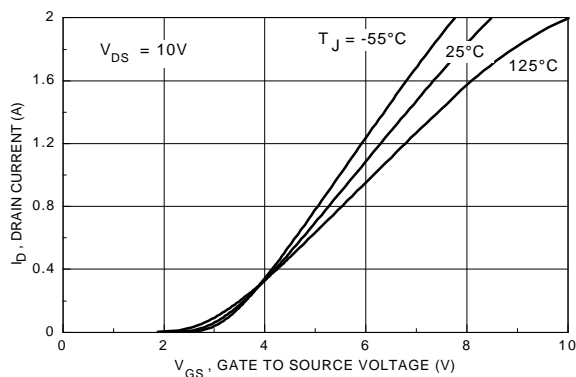

Figure 5. Transfer Characteristics.

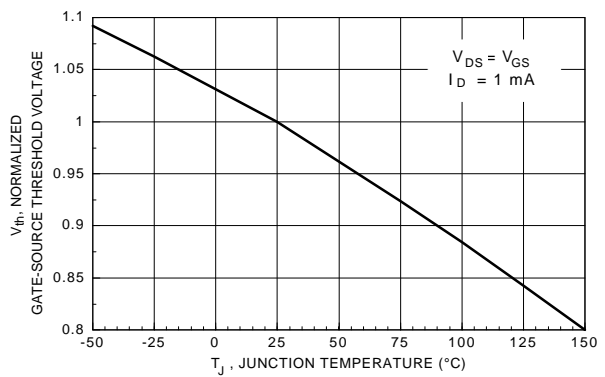

Figure 6. Gate Threshold Variation with Temperature.

Typical Electrical Characteristics (continued)

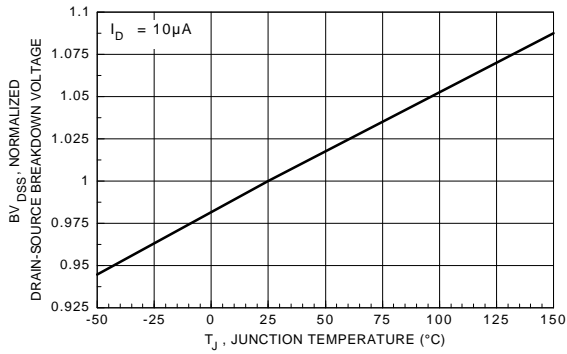

Figure 7. Breakdown Voltage Variation with Temperature.

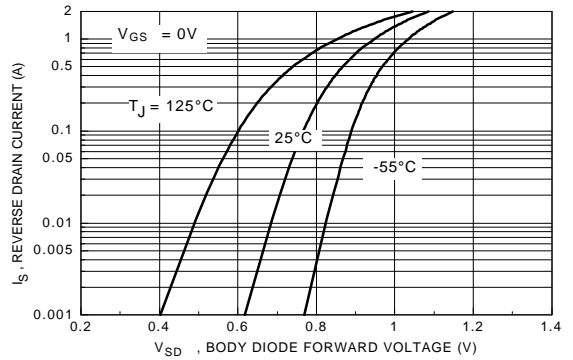

Figure 8. Body Diode Forward Voltage Variation with Current and Temperature.

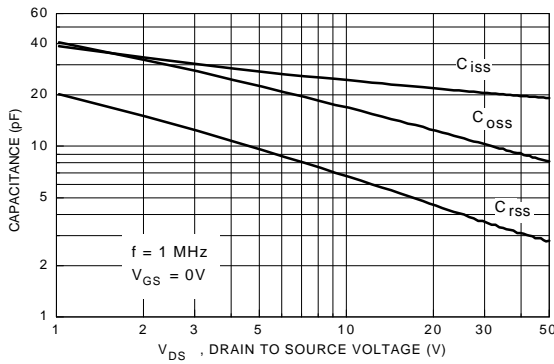

Figure 9. Capacitance Characteristics.

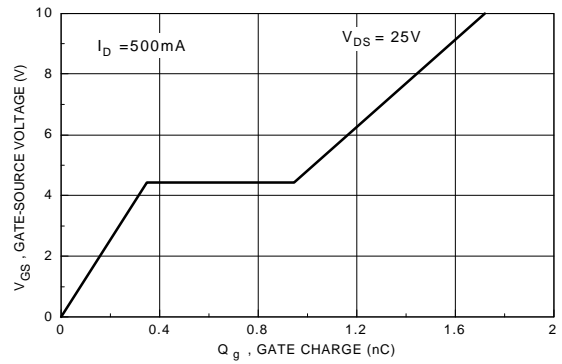

Figure 10. Gate Charge Characteristics.

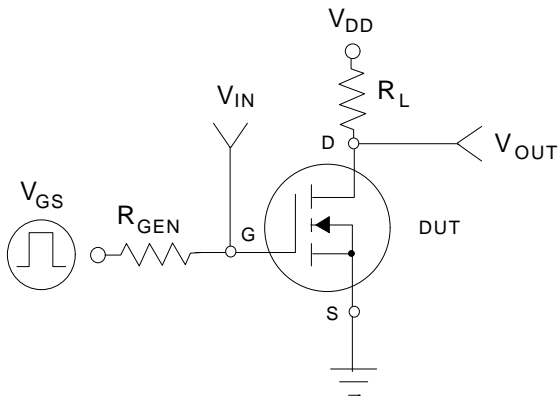

Figure 11. Switching Test Circuit.

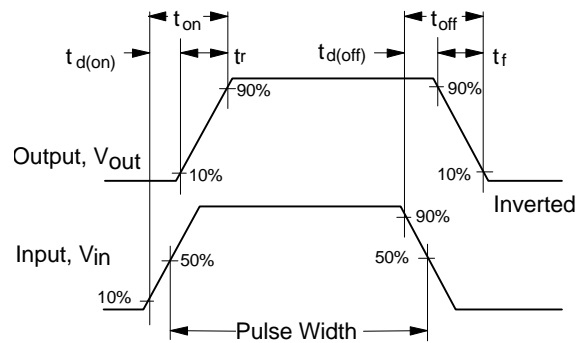

Figure 12. Switching Waveforms.

Typical Electrical Characteristics (continued)

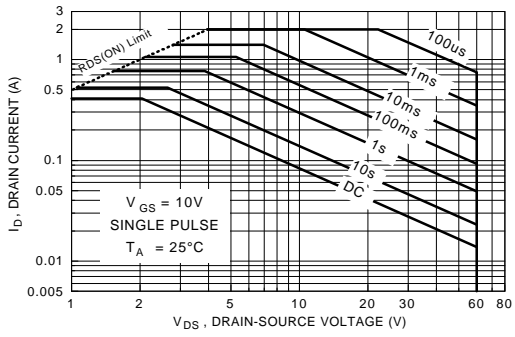

Figure 13. Maximum Safe Operating Area.

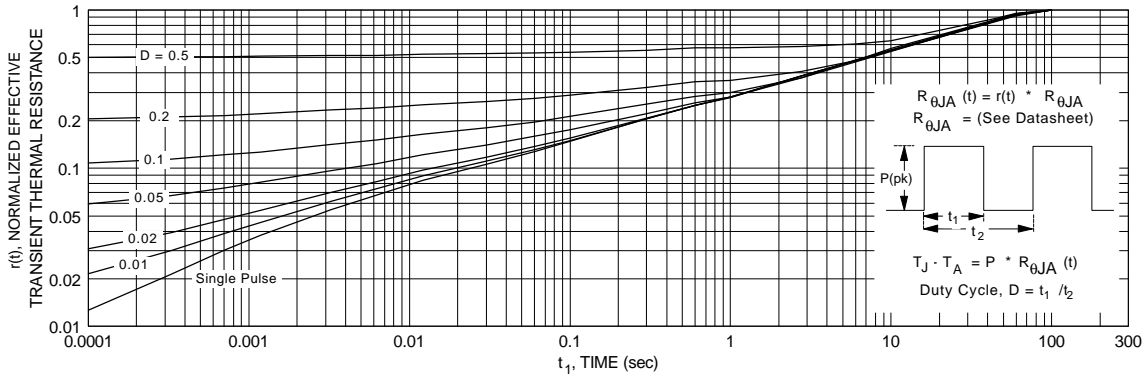

Figure 14. Transient Thermal Response Curve.

TO-92 Tape and Reel Data



TO-92 Packaging Configuration: Figure 1.0

FSCINT Label sample



F63TNR Label sample



TO-92 TNR/AMMO PACKING INFORMATION

| Packing | Style | Quantity | EOL code |
|---------|-------|----------|----------|
| Reel | A | 2,000 | D26Z |
| | E | 2,000 | D27Z |
| Ammo | M | 2,000 | D74Z |
| | P | 2,000 | D75Z |

Unit weight = 0.22 gm
 Reel weight with components = 1.04 kg
 Ammo weight with components = 1.02 kg
 Max quantity per intermediate box = 10,000 units



(TO-92) BULK PACKING INFORMATION

| EOL CODE | DESCRIPTION | LEADCLIP DIMENSION | QUANTITY |
|-------------|---|--------------------|-------------|
| J18Z | TO-18 OPTION STD | NO LEAD CLIP | 2.0 K / BOX |
| J05Z | TO-5 OPTION STD | NO LEAD CLIP | 1.5 K / BOX |
| NO EOL CODE | TO-92 STANDARD STRAIGHT FOR: PKG 92, 94 (NON PROELECTRON SERIES), 96 | NO LEADCLIP | 2.0 K / BOX |
| L34Z | TO-92 STANDARD STRAIGHT FOR: PKG 94 (PROELECTRON SERIES BCXXX, BFXXX, BSRXXX), 97, 98 | NO LEADCLIP | 2.0 K / BOX |

BULK OPTION

See Bulk Packing Information table

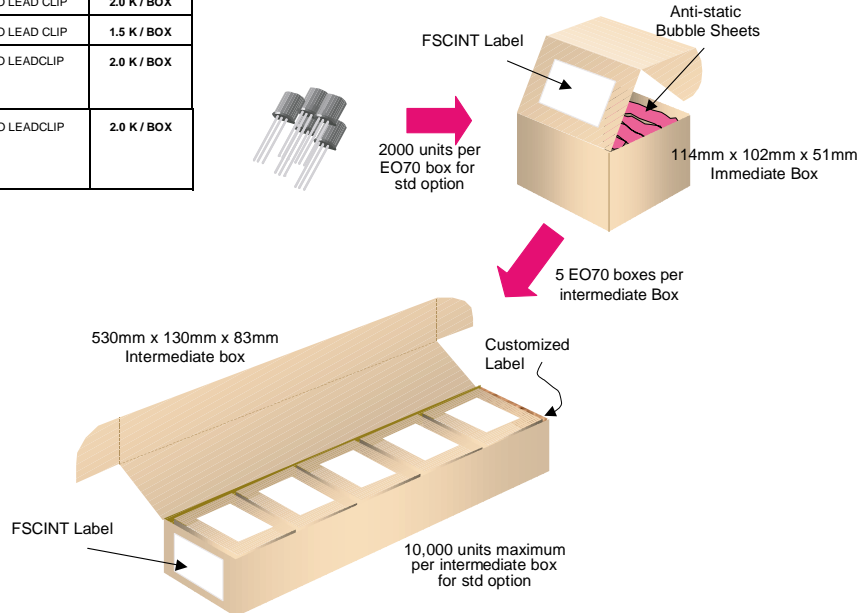

TO-92 Tape and Reel Data, continued

TO-92 Reeling Style

Configuration: Figure 2.0

Machine Option "A" (H)



Style "A", D26Z, D70Z (s/h)

Machine Option "E" (J)



Style "E", D27Z, D71Z (s/h)

TO-92 Radial Ammo Packaging

Configuration: Figure 3.0

FIRST WIRE OFF IS COLLECTOR
ADHESIVE TAPE IS ON THE TOP SIDE
FLAT OF TRANSISTOR IS ON TOP



ORDER STYLE
D74Z (M)

FIRST WIRE OFF IS EMITTER (ON PKG. 92)
ADHESIVE TAPE IS ON BOTTOM SIDE
FLAT OF TRANSISTOR IS ON BOTTOM

FIRST WIRE OFF IS EMITTER
ADHESIVE TAPE IS ON THE TOP SIDE
FLAT OF TRANSISTOR IS ON BOTTOM



ORDER STYLE
D75Z (P)

FIRST WIRE OFF IS COLLECTOR (ON PKG. 92)
ADHESIVE TAPE IS ON BOTTOM SIDE
FLAT OF TRANSISTOR IS ON TOP

TO-92 Tape and Reel Data, continued

**TO-92 Tape and Reel Taping
Dimension Configuration: Figure 4.0**

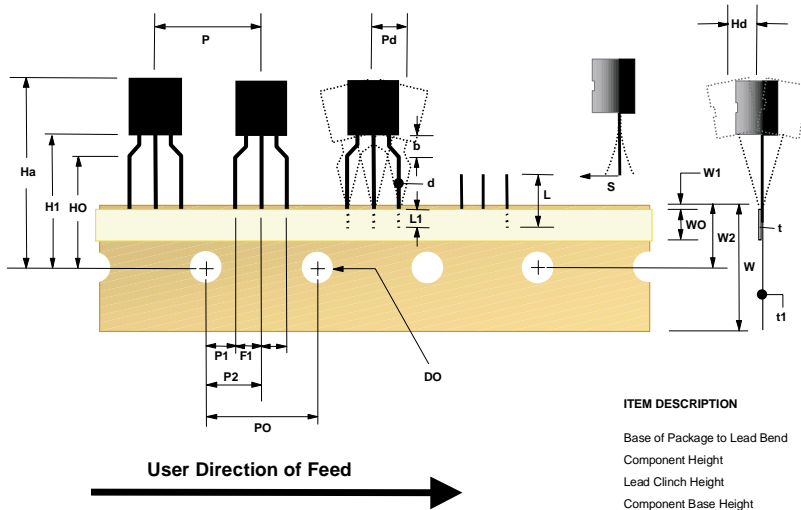

| ITEM DESCRIPTION | SYMBOL | DIMENSION |
|------------------------------------|--------|------------------------|
| Base of Package to Lead Bend | b | 0.098 (max) |
| Component Height | Ha | 0.928 (+/- 0.025) |
| Lead Clinch Height | HO | 0.630 (+/- 0.020) |
| Component Base Height | H1 | 0.748 (+/- 0.020) |
| Component Alignment (side/side) | Pd | 0.040 (max) |
| Component Alignment (front/back) | Hd | 0.031 (max) |
| Component Pitch | P | 0.500 (+/- 0.020) |
| Feed Hole Pitch | PO | 0.500 (+/- 0.008) |
| Hole Center to First Lead | P1 | 0.150 (+0.009, -0.010) |
| Hole Center to Component Center | P2 | 0.247 (+/- 0.007) |
| Lead Spread | F1/F2 | 0.104 (+/- 0.010) |
| Lead Thickness | d | 0.018 (+0.002, -0.003) |
| Cut Lead Length | L | 0.429 (max) |
| Taped Lead Length | L1 | 0.209 (+0.051, -0.052) |
| Taped Lead Thickness | t | 0.032 (+/- 0.006) |
| Carrier Tape Thickness | t1 | 0.021 (+/- 0.006) |
| Carrier Tape Width | W | 0.708 (+0.020, -0.019) |
| Hold - down Tape Width | WO | 0.236 (+/- 0.012) |
| Hold - down Tape position | W1 | 0.035 (max) |
| Feed Hole Position | W2 | 0.360 (+/- 0.025) |
| Sprocket Hole Diameter | DO | 0.157 (+0.008, -0.007) |
| Lead Spring Out | S | 0.004 (max) |

Note : All dimensions are in inches.

**TO-92 Reel
Configuration: Figure 5.0**



| ITEM DESCRIPTION | SYMBOL | MINIMUM | MAXIMUM |
|--------------------------------|--------|---------|---------|
| Reel Diameter | D1 | 13.975 | 14.025 |
| Arbor Hole Diameter (Standard) | D2 | 1.160 | 1.200 |
| (Small Hole) | D2 | 0.650 | 0.700 |
| Core Diameter | D3 | 3.100 | 3.300 |
| Hub Recess Inner Diameter | D4 | 2.700 | 3.100 |
| Hub Recess Depth | W1 | 0.370 | 0.570 |
| Flange to Flange Inner Width | W2 | 1.630 | 1.690 |
| Hub to Hub Center Width | W3 | | 2.090 |

Note: All dimensions are in inches

TO-92 Package Dimensions



TO-92; TO-18 Reverse Lead Form (J35Z Option) (FS PKG Code 92, 94, 96)

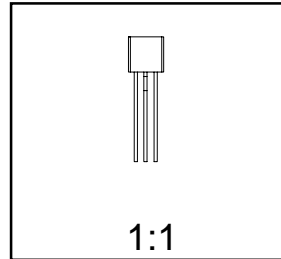
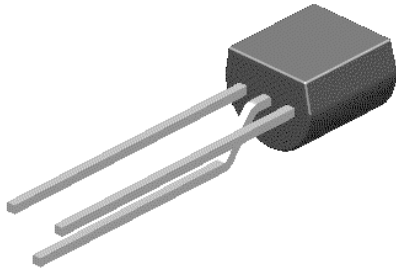

Scale 1:1 on letter size paper

Dimensions shown below are in:
inches [millimeters]

Part Weight per unit (gram): 0.22

TO-92(92,94,96,97*,98*);
TO-18 REVERSE LEADFORM
(J35Z)

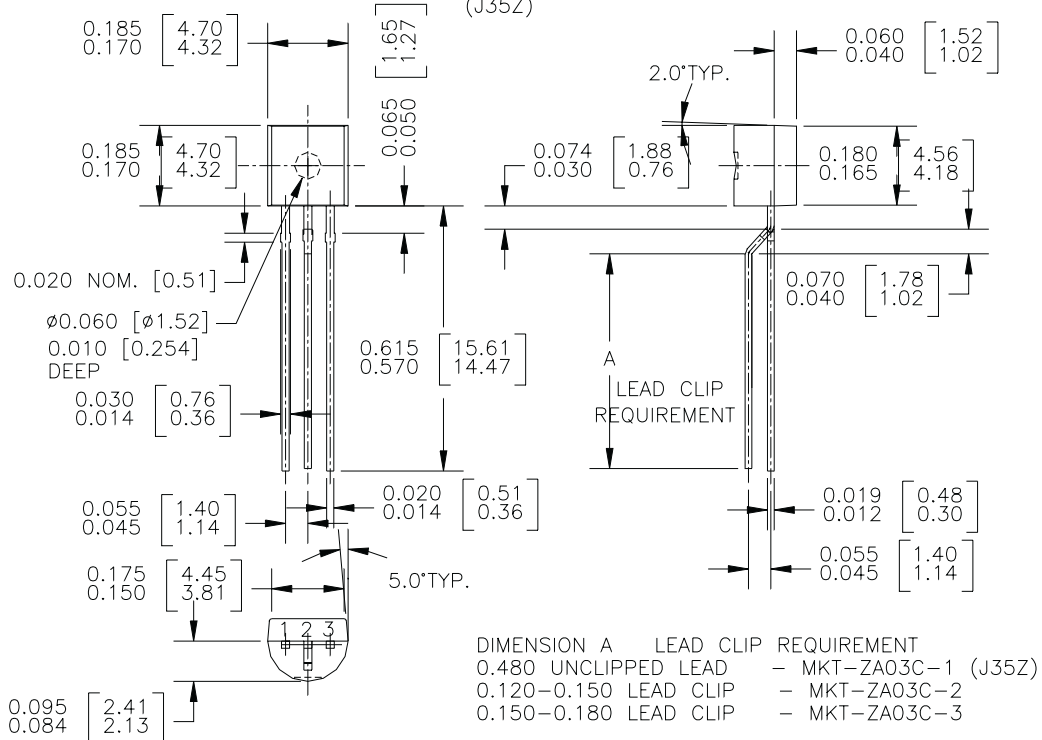

Note: All package 97 or 98 transistors are leadformed to this configuration prior to bulk shipment. Order L34Z option if in-line leads are preferred on package 97 or 98.

* Standard Option on 97 & 98 package code

TRADEMARKS

The following are registered and unregistered trademarks Fairchild Semiconductor owns or is authorized to use and is not intended to be an exhaustive list of all such trademarks.

| | | | |
|-----------------------------------|----------------------------------|----------------------------------|-------------------------|
| ACE ^x TM | FAST ^r TM | PowerTrench [®] | SyncFET TM |
| Bottomless TM | GlobalOptoisolator TM | QFET TM | TinyLogic TM |
| CoolFET TM | GTO TM | QS TM | UHC TM |
| CROSSVOLT TM | HiSeC TM | QT Optoelectronics TM | VCX TM |
| DOME TM | ISOPLANAR TM | Quiet Series TM | |
| E ² CMOS TM | MICROWIRE TM | SILENT SWITCHER [®] | |
| EnSigna TM | OPTOLOGIC TM | SMART START TM | |
| FACT TM | OPTOPLANAR TM | SuperSOT TM -3 | |
| FACT Quiet Series TM | PACMAN TM | SuperSOT TM -6 | |
| FAST [®] | POP TM | SuperSOT TM -8 | |

DISCLAIMER

FAIRCHILD SEMICONDUCTOR RESERVES THE RIGHT TO MAKE CHANGES WITHOUT FURTHER NOTICE TO ANY PRODUCTS HEREIN TO IMPROVE RELIABILITY, FUNCTION OR DESIGN. FAIRCHILD DOES NOT ASSUME ANY LIABILITY ARISING OUT OF THE APPLICATION OR USE OF ANY PRODUCT OR CIRCUIT DESCRIBED HEREIN; NEITHER DOES IT CONVEY ANY LICENSE UNDER ITS PATENT RIGHTS, NOR THE RIGHTS OF OTHERS.

LIFE SUPPORT POLICY

FAIRCHILD'S PRODUCTS ARE NOT AUTHORIZED FOR USE AS CRITICAL COMPONENTS IN LIFE SUPPORT DEVICES OR SYSTEMS WITHOUT THE EXPRESS WRITTEN APPROVAL OF FAIRCHILD SEMICONDUCTOR CORPORATION. As used herein:

1. Life support devices or systems are devices or systems which, (a) are intended for surgical implant into the body, or (b) support or sustain life, or (c) whose failure to perform when properly used in accordance with instructions for use provided in the labeling, can be reasonably expected to result in significant injury to the user.
2. A critical component is any component of a life support device or system whose failure to perform can be reasonably expected to cause the failure of the life support device or system, or to affect its safety or effectiveness.

PRODUCT STATUS DEFINITIONS

Definition of Terms

| Datasheet Identification | Product Status | Definition |
|--------------------------|------------------------|---|
| Advance Information | Formative or In Design | This datasheet contains the design specifications for product development. Specifications may change in any manner without notice. |
| Preliminary | First Production | This datasheet contains preliminary data, and supplementary data will be published at a later date. Fairchild Semiconductor reserves the right to make changes at any time without notice in order to improve design. |
| No Identification Needed | Full Production | This datasheet contains final specifications. Fairchild Semiconductor reserves the right to make changes at any time without notice in order to improve design. |
| Obsolete | Not In Production | This datasheet contains specifications on a product that has been discontinued by Fairchild semiconductor. The datasheet is printed for reference information only. |

ON Semiconductor and  are trademarks of Semiconductor Components Industries, LLC dba ON Semiconductor or its subsidiaries in the United States and/or other countries. ON Semiconductor owns the rights to a number of patents, trademarks, copyrights, trade secrets, and other intellectual property. A listing of ON Semiconductor's product/patent coverage may be accessed at www.onsemi.com/site/pdf/Patent-Marking.pdf. ON Semiconductor reserves the right to make changes without further notice to any products herein. ON Semiconductor makes no warranty, representation or guarantee regarding the suitability of its products for any particular purpose, nor does ON Semiconductor assume any liability arising out of the application or use of any product or circuit, and specifically disclaims any and all liability, including without limitation special, consequential or incidental damages. Buyer is responsible for its products and applications using ON Semiconductor products, including compliance with all laws, regulations and safety requirements or standards, regardless of any support or applications information provided by ON Semiconductor. "Typical" parameters which may be provided in ON Semiconductor data sheets and/or specifications can and do vary in different applications and actual performance may vary over time. All operating parameters, including "Typicals" must be validated for each customer application by customer's technical experts. ON Semiconductor does not convey any license under its patent rights nor the rights of others. ON Semiconductor products are not designed, intended, or authorized for use as a critical component in life support systems or any FDA Class 3 medical devices or medical devices with a same or similar classification in a foreign jurisdiction or any devices intended for implantation in the human body. Should Buyer purchase or use ON Semiconductor products for any such unintended or unauthorized application, Buyer shall indemnify and hold ON Semiconductor and its officers, employees, subsidiaries, affiliates, and distributors harmless against all claims, costs, damages, and expenses, and reasonable attorney fees arising out of, directly or indirectly, any claim of personal injury or death associated with such unintended or unauthorized use, even if such claim alleges that ON Semiconductor was negligent regarding the design or manufacture of the part. ON Semiconductor is an Equal Opportunity/Affirmative Action Employer. This literature is subject to all applicable copyright laws and is not for resale in any manner.

PUBLICATION ORDERING INFORMATION

LITERATURE FULFILLMENT:

Literature Distribution Center for ON Semiconductor
19521 E. 32nd Pkwy, Aurora, Colorado 80011 USA
Phone: 303-675-2175 or 800-344-3860 Toll Free USA/Canada
Fax: 303-675-2176 or 800-344-3867 Toll Free USA/Canada
Email: orderlit@onsemi.com

N. American Technical Support: 800-282-9855 Toll Free
USA/Canada
Europe, Middle East and Africa Technical Support:
Phone: 421 33 790 2910
Japan Customer Focus Center
Phone: 81-3-5817-1050

ON Semiconductor Website: www.onsemi.com
Order Literature: <http://www.onsemi.com/orderlit>
For additional information, please contact your local
Sales Representative