



Is Now Part of



**ON Semiconductor®**

To learn more about ON Semiconductor, please visit our website at  
[www.onsemi.com](http://www.onsemi.com)

ON Semiconductor and the ON Semiconductor logo are trademarks of Semiconductor Components Industries, LLC dba ON Semiconductor or its subsidiaries in the United States and/or other countries. ON Semiconductor owns the rights to a number of patents, trademarks, copyrights, trade secrets, and other intellectual property. A listing of ON Semiconductor's product/patent coverage may be accessed at [www.onsemi.com/site/pdf/Patent-Marking.pdf](http://www.onsemi.com/site/pdf/Patent-Marking.pdf). ON Semiconductor reserves the right to make changes without further notice to any products herein. ON Semiconductor makes no warranty, representation or guarantee regarding the suitability of its products for any particular purpose, nor does ON Semiconductor assume any liability arising out of the application or use of any product or circuit, and specifically disclaims any and all liability, including without limitation special, consequential or incidental damages. Buyer is responsible for its products and applications using ON Semiconductor products, including compliance with all laws, regulations and safety requirements or standards, regardless of any support or applications information provided by ON Semiconductor. "Typical" parameters which may be provided in ON Semiconductor data sheets and/or specifications can and do vary in different applications and actual performance may vary over time. All operating parameters, including "Typicals" must be validated for each customer application by customer's technical experts. ON Semiconductor does not convey any license under its patent rights nor the rights of others. ON Semiconductor products are not designed, intended, or authorized for use as a critical component in life support systems or any FDA Class 3 medical devices or medical devices with a same or similar classification in a foreign jurisdiction or any devices intended for implantation in the human body. Should Buyer purchase or use ON Semiconductor products for any such unintended or unauthorized application, Buyer shall indemnify and hold ON Semiconductor and its officers, employees, subsidiaries, affiliates, and distributors harmless against all claims, costs, damages, and expenses, and reasonable attorney fees arising out of, directly or indirectly, any claim of personal injury or death associated with such unintended or unauthorized use, even if such claim alleges that ON Semiconductor was negligent regarding the design or manufacture of the part. ON Semiconductor is an Equal Opportunity/Affirmative Action Employer. This literature is subject to all applicable copyright laws and is not for resale in any manner.



# FSL4110LR 1000 V SenseFET Integrated Power Switch

## Features

- Built-in Avalanche Rugged 1000 V SenseFET
- Precise Fixed Operating Frequency: 50 kHz
- $V_{CC}$  can be supplied from either bias-winding or self-biasing.
- Soft Burst-Mode Operation Minimizing Audible Noise
- Random Frequency Fluctuation for Low EMI
- Pulse-by-Pulse Current Limit
- Various Protection Functions: Overload Protection (OLP), Over-Voltage Protection (OVP), Abnormal Over-Current Protection (AOCP), Internal Thermal Shutdown (TSD) with Hysteresis. Under-Voltage Lockout (UVLO) and Line Over-Voltage Protection (LOVP) with Hysteresis.
- Built-in Internal Startup and Soft-Start Circuit
- Fixed 1.6 s Restart Time for Safe Auto-Restart Mode of All Protections

## Description

The FSL4110LR is an integrated pulse width modulation (PWM) controller and 1000 V avalanche rugged SenseFET specifically designed for high input voltage offline Switching Mode Power Supplies (SMPS) with minimal external components.  $V_{CC}$  can be supplied through integrated high-voltage power regulator without auxiliary bias winding.

The integrated PWM controller includes a fixed-frequency oscillator, Under-Voltage Lockout (UVLO), Leading-Edge Blanking (LEB), optimized gate driver, soft-start, temperature-compensated precise current sources for loop-compensation, and variable protection circuitry.

Compared with a discrete MOSFET and PWM controller solution, the FSL4110LR reduces total cost, component count, PCB size, and weight; while simultaneously increasing efficiency, productivity, and system reliability. This device provides a basic platform for cost-effective design of a flyback converter.

## Applications

- SMPS for Electric Metering
- Auxiliary Power Supply for 3-Phase Input Industrial Systems

## Ordering Information

Part Number	Package	Operating Junction Temperature	Current Limit	$R_{DS(ON)}$ (Max.)	Output Power Table <sup>(1)</sup>	
					45~460 $V_{AC}$ <sup>(2)</sup>	85~460 $V_{AC}$ <sup>(2)</sup>
FSL4110LRN	7-DIP	-40°C ~ 125°C	0.52 A	10 $\Omega$	4 W <sup>(3)</sup>	9 W <sup>(3)</sup>
FSL4110LRLX	7-LSOP					

### Notes:

1. The junction temperature can limit the maximum output power.
2. Maximum practical continuous power in an open-frame design at 50 °C ambient temperatures.
3. Bias winding condition.



## Pin Configuration

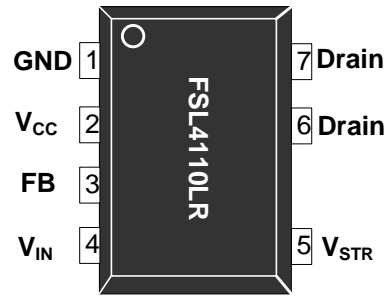


Figure 3. Pin Configuration (Top View)

## Pin Definitions

Pin #	Name	Description
1	GND	Ground. The SenseFET source terminal on primary side and the internal PWM control ground.
2	V <sub>CC</sub>	Power Supply Voltage Input. This pin is the positive supply input, which provides the internal operating current for startup and steady-state operation. This voltage is supplied from internal high-voltage regulator via pin 5 (V <sub>STR</sub> ) during startup (see Figure 2). When the external bias voltage is higher than 10 V, internal high voltage regulator is disable. A ceramic capacitor need to be placed as close as possible between this pin and pin 1 (GND). Recommended distance is less than 3 mm.
3	FB	Feedback. This pin is internally connected to the inverting input to the PWM comparator. This pin has a 100 μA current source internally. The collector of an opto-coupler is typically tied to this pin. A capacitor should be placed between this pin and GND. A resistor should be connected between this pin and pin 2 (V <sub>CC</sub> ) to generate delay current (I <sub>DELAY</sub> ) for overload protection delay time. The resistance should not be exceed 5 MΩ in self-biasing.
4	V <sub>IN</sub>	Line Over-Voltage Input. This pin is the input of divided line voltage. The voltage is divided by resistors. When this voltage is higher than 2 V, the FSL4110LR is not operationed. If this pin is not used, it should be connected to the ground.
5	V <sub>STR</sub>	Startup. Connected to the rectified AC line voltage source. At startup, the internal switch supplies internal bias and charges an external storage capacitor placed between V <sub>CC</sub> pin and ground. Once V <sub>CC</sub> reaches 12 V, all internal blocks are activated. The internal high-voltage regulator turns on and off to maintain V <sub>CC</sub> at 10 V without auxiliary bias winding.
6, 7	Drain	Drain. Designed to connect directly to the primary lead of the transformer and capable of switching a maximum of 1000 V. Minimizing the length of the trace connecting these pins to the transformer decreases leakage inductance.

## Absolute Maximum Ratings

Stresses exceeding the absolute maximum ratings may damage the device. The device may not function or be operable above the recommended operating conditions and stressing the parts to these levels is not recommended. In addition, extended exposure to stresses above the recommended operating conditions may affect device reliability. The absolute maximum ratings are stress ratings only.

Symbol	Parameter	Min.	Max.	Unit
$V_{STR}$	$V_{STR}$ Pin Voltage		700	V
$V_{DS}$	Drain Pin Voltage		1000	V
$V_{CC}$	$V_{CC}$ Pin Voltage		27	V
$V_{FB}$	Feedback Pin Voltage <sup>(6)</sup>	-0.3	12.0	V
$V_{IN}$	$V_{IN}$ Pin Voltage <sup>(6)</sup>	-0.3	12.0	V
$I_{DM}$	Drain Current Pulsed		4	A
$I_{DS}$	Continuous Switching Drain Current <sup>(7)</sup>	$T_C=25^\circ\text{C}$	1	A
		$T_C=100^\circ\text{C}$	0.6	A
$E_{AS}$	Single Pulsed Avalanche Energy <sup>(8)</sup>		51	mJ
$P_D$	Total Power Dissipation ( $T_C=25^\circ\text{C}$ ) <sup>(9)</sup>		1.5	W
$T_J$	Maximum Junction Temperature		150	$^\circ\text{C}$
	Operating Junction Temperature <sup>(10)</sup>	-40	+125	$^\circ\text{C}$
TSTG	Storage Temperature	-55	+150	$^\circ\text{C}$

### Notes:

- $V_{FB}$  and  $V_{IN}$  are clamped by internal clamping diode (11 V,  $I_{CLAMP\_MAX} < 100 \mu\text{A}$ ).
- Repetitive peak switching current when the inductive load is assumed: Limited by maximum duty ( $D_{MAX}=0.73$ ) and junction temperature (see Figure 4).
- $I_{AS} = 3.2 \text{ A}$ ,  $L = 10 \text{ mH}$ , starting  $T_J=25^\circ\text{C}$ .
- Infinite cooling condition (refer to the SEMI G30-88).
- Although this parameter guarantees IC operation, it does not guarantee all electrical characteristics.

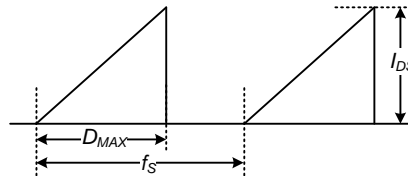


Figure 4. Repetitive Peak Switching Current

## Thermal Impedance

Symbol	Parameter	Value	Unit
$\theta_{JA}$	Junction-to-Ambient Thermal Impedance <sup>(11)</sup>	85	$^\circ\text{C/W}$

### Note:

- JEDEC recommended environment, JESD51-2, and test board, JESD51-3, with minimum land pattern.

## ESD Capability

Symbol	Parameter	Value	Unit
ESD	Human Body Model, ANSI/ESDA/JEDEC JS-001-2012	5.0	KV
	Charged Device Model, JESD22-C101	2.0	

## Electrical Characteristics

$T_J = -40^{\circ}\text{C}$  to  $125^{\circ}\text{C}$  unless otherwise specified.

Symbol	Parameter	Conditions	Min.	Typ.	Max.	Unit
<b>SenseFET Section</b>						
$BV_{DSS}$	Drain-Source Breakdown Voltage <sup>(12)</sup>	$V_{GS} = 0\text{ V}, I_D = 250\ \mu\text{A}$	1000			V
$I_{DSS}$	Zero-Gate-Voltage Drain Current <sup>(12)</sup>	$V_{DS} = 1000\text{ V}, V_{GS} = 0\text{ V}$			250	$\mu\text{A}$
$R_{DS(ON)}$	Drain-Source On-State Resistance <sup>(12)</sup>	$V_{GS} = 10\text{ V}, I_D = 1.0\text{ A}$			10	$\Omega$
$C_{ISS}$	Input Capacitance <sup>(12)(13)</sup>	$V_{DS} = 25\text{ V}, V_{GS} = 0\text{ V},$ $f = 1\text{ MHz}$		367	477	pF
$C_{OSS}$	Output Capacitance <sup>(12)(13)</sup>			37.5	48.8	pF
$t_{d(on)}$	Turn-On Delay Time <sup>(12)</sup>	$V_{DD} = 500\text{ V}, I_D = 1.0\text{ A},$ $V_{GS} = 10\text{ V}, R_g = 25\ \Omega$		13.7		ns
$t_r$	Rise Time <sup>(12)</sup>			14		ns
$t_{d(off)}$	Turn-Off Delay Time <sup>(12)</sup>			33		ns
$t_f$	Fall Time <sup>(12)</sup>			45		ns
<b>Control Section</b>						
$f_s$	Switching Frequency <sup>(12)</sup>	$V_{CC} = 14\text{ V}, V_{FB} = 4\text{ V}$	46.5	50.0	53.5	kHz
$f_M$	Frequency Modulation <sup>(13)</sup>			$\pm 1.5$		kHz
$D_{MAX}$	Maximum Duty Ratio	$V_{CC} = 14\text{ V}, V_{FB} = 4\text{ V}$	61	67	73	%
$I_{FB}$	Feedback Source Current <sup>(12)</sup>	$V_{FB} = 0\text{ V}$	70	100	130	$\mu\text{A}$
$V_{START}$	UVLO Threshold Voltage	$V_{FB} = 0\text{ V}, V_{CC}$ Sweep	11	12	13	V
$V_{STOP}$		After Turn-on, $V_{FB} = 0\text{ V}$	7	8	9	
$t_{S/S}$	Internal Soft-Start Time	$V_{STR} = 40\text{ V}, V_{CC}$ Sweep		20		ms
<b>Burst-Mode Section</b>						
$V_{BURH}$	Burst-Mode Voltage <sup>(12)</sup>	$V_{CC} = 14\text{ V}, V_{FB}$ Sweep	0.45	0.50	0.55	V
$V_{BURL}$			0.35	0.40	0.45	V
$V_{HYS}$				100		mV
<b>Protection Section</b>						
$I_{LIM}$	Peak Drain Current Limit <sup>(12)</sup>	$di/dt = 240\text{ mA}/\mu\text{s}$	0.45	0.52	0.59	A
$V_{OLP}$	Overload Protection <sup>(12)</sup>	$V_{CC} = 14\text{ V}, V_{FB}$ Sweep	4.0	4.4	4.8	V
$V_{AOCP}$	Abnormal Over-Current Protection <sup>(13)</sup>			1.0		V
$t_{LEB}$	Leading-Edge Blanking Time <sup>(13)(14)</sup>			250		ns
$t_{CLD}$	Current Limit Delay Time <sup>(13)</sup>				200	ns
$V_{OVP}$	Over-Voltage Protection	$V_{CC}$ Sweep	23.0	24.5	26.0	V
$V_{INH}$	Line Over-Voltage Protection Threshold Voltage	$V_{CC} = 14\text{ V}, V_{IN}$ Sweep	1.9	2.0	2.1	V
$V_{INHYS}$	Line Over-Voltage Protection Hysteresis <sup>(12)</sup>	$V_{CC} = 14\text{ V}, V_{IN}$ Sweep		100		mV
$t_{DELAY}$	Overload Protection Delay			100		ms
$t_{RESTART}$	Restart Time After Protection <sup>(13)</sup>			1.6		s
TSD	Thermal Shutdown Temperature <sup>(13)</sup>	Shutdown Temperature	130	140	150	$^{\circ}\text{C}$
$T_{HYS}$		Hysteresis (FSL4110LRN)		60		
$T_{HYS}$		Hysteresis (FSL4110LRLX)		30		

Continued on the following page...

**Electrical Characteristics** (Continued)T<sub>J</sub> = -40°C to 125°C unless otherwise specified.

Symbol	Parameter	Conditions	Min.	Typ.	Max.	Unit
<b>High Voltage Regulator Section</b>						
V <sub>HVREG</sub>	HV Regulator Voltage	V <sub>FB</sub> = 0 V, V <sub>STR</sub> = 40 V	9	10	11	V
<b>Total Device Section</b>						
I <sub>OP</sub>	Operating Supply Current, (Control Part in Burst Mode) <sup>(12)</sup>	V <sub>CC</sub> = 14 V, V <sub>FB</sub> = 0 V		0.40	0.50	mA
I <sub>OPS</sub>	Operating Switching Current, (Control Part and SenseFET Part) <sup>(12)</sup>	V <sub>CC</sub> = 14 V, V <sub>FB</sub> = 2 V		1.00	1.35	mA
I <sub>START</sub>	Start Current <sup>(12)</sup>	V <sub>CC</sub> = 11 V (Before V <sub>CC</sub> Reaches V <sub>START</sub> )		160	240	μA
I <sub>CH</sub>	Startup Charging Current <sup>(12)</sup>	V <sub>CC</sub> = V <sub>FB</sub> = 0 V, V <sub>STR</sub> = 40 V	1.5	2.0		mA
V <sub>STR</sub>	Minimum V <sub>STR</sub> Supply Voltage	C <sub>VCC</sub> = 0.1 μF, V <sub>STR</sub> Sweep			26	V

**Notes:**

12. T<sub>J</sub> = 25°C.
13. Although these parameters are guaranteed, they are not 100% tested in production.
14. t<sub>LEB</sub> includes gate turn-on time.

## Typical Performance Characteristics

Characteristic graphs are normalized at  $T_A=25^\circ\text{C}$ .

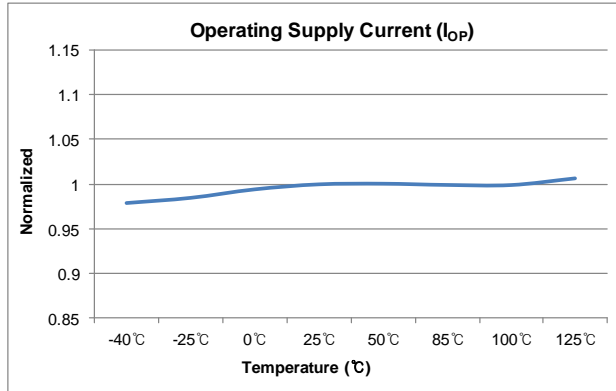


Figure 5. Operating Supply Current ( $I_{OP}$ ) vs.  $T_A$

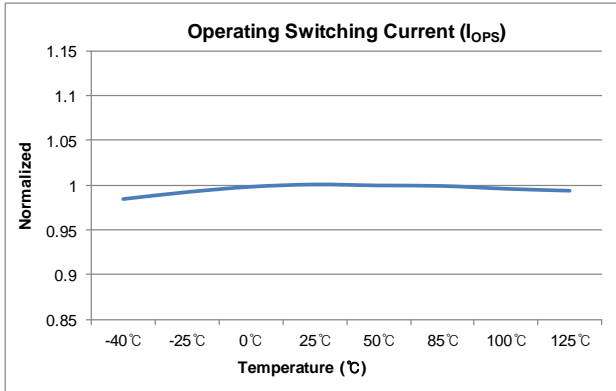


Figure 6. Operating Switching Current ( $I_{OPS}$ ) vs.  $T_A$

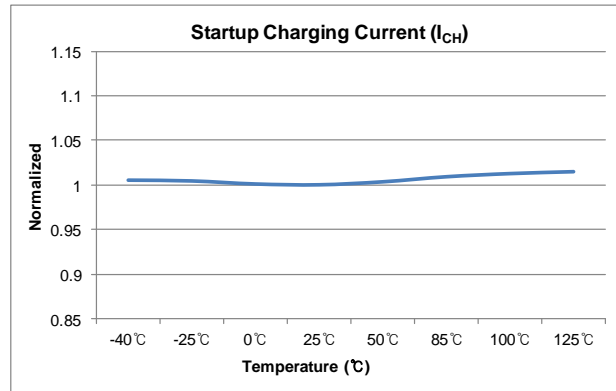


Figure 7. Startup Charging Current ( $I_{CH}$ ) vs.  $T_A$

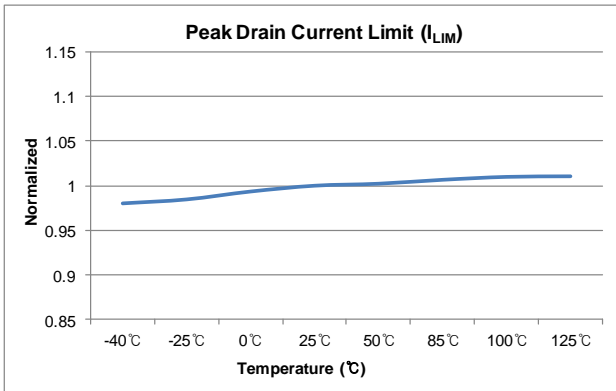


Figure 8. Peak Drain Current Limit ( $I_{LIM}$ ) vs.  $T_A$

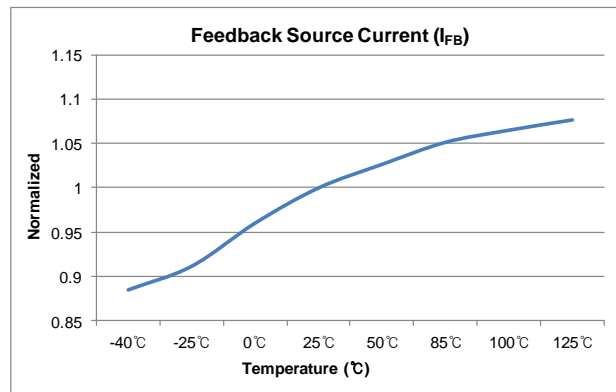


Figure 9. Feedback Source Current ( $I_{FB}$ ) vs.  $T_A$

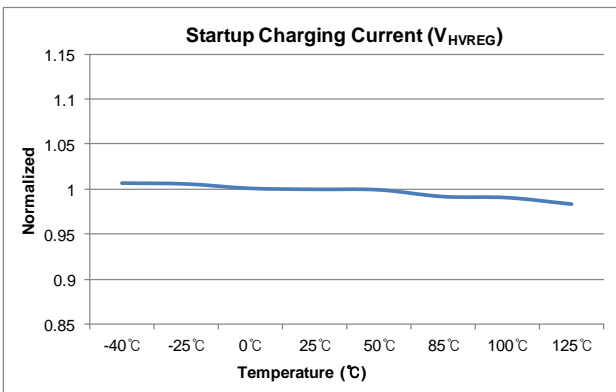


Figure 10. HV Regulator Voltage ( $V_{HVREG}$ ) vs.  $T_A$



## Typical Performance Characteristics (Continued)

Characteristic graphs are normalized at  $T_A=25^\circ\text{C}$ .

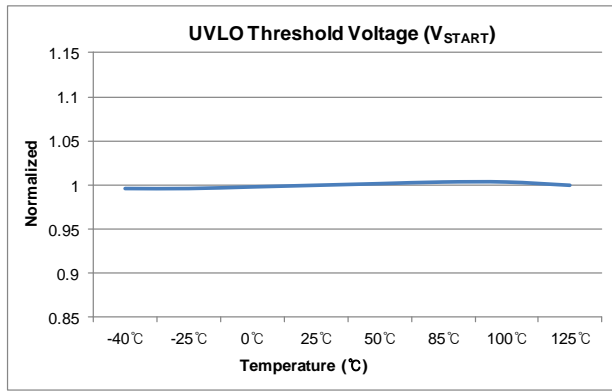


Figure 11. UVLO Threshold Voltage ( $V_{START}$ ) vs.  $T_A$

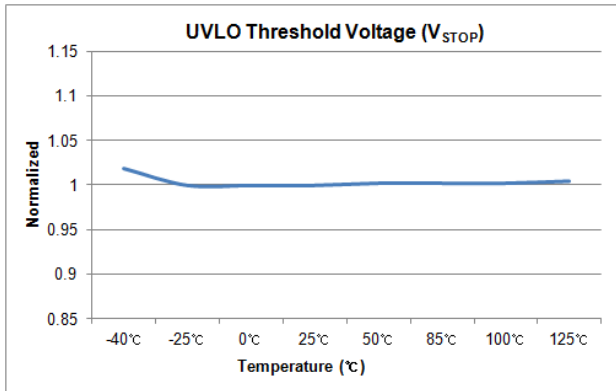


Figure 12. UVLO Threshold Voltage ( $V_{STOP}$ ) vs.  $T_A$

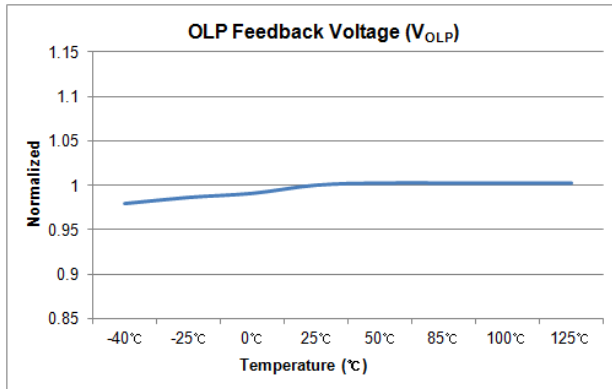


Figure 13. OLP Feedback Voltage ( $V_{OLP}$ ) vs.  $T_A$

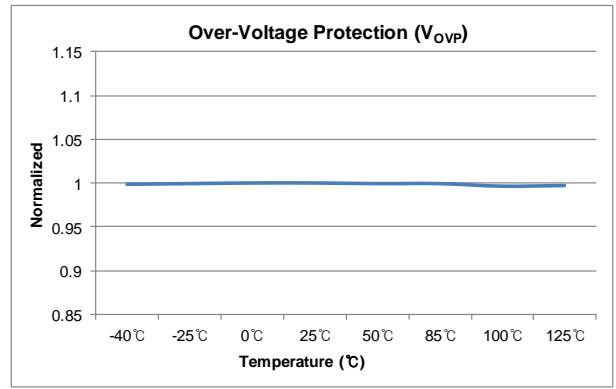


Figure 14. Over-Voltage Protection ( $V_{OVP}$ ) vs.  $T_A$

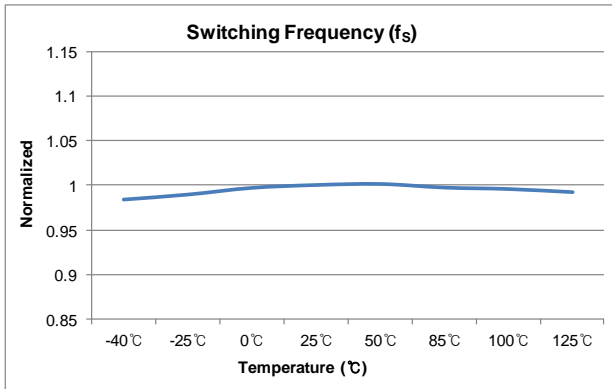


Figure 15. Switching Frequency ( $f_s$ ) vs.  $T_A$

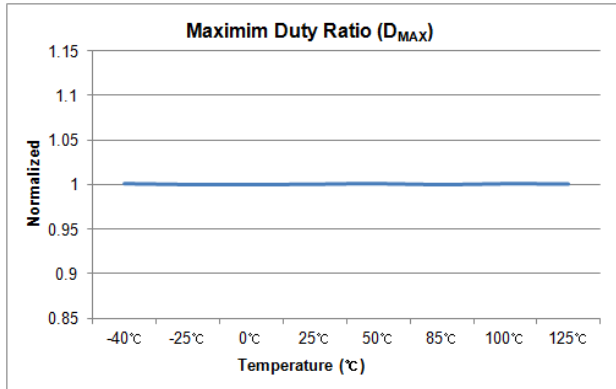


Figure 16. Maximum Duty Ratio ( $D_{MAX}$ ) vs.  $T_A$

## Functional Description

### 1. Startup and High-Voltage Regulator

During startup, an internal high-voltage current source ( $I_{CH}$ ) of the high-voltage regulator ( $HV_{REG}$ ) supplies the internal bias current ( $I_{START}$ ) and charges the external capacitor ( $C_{VCC}$ ) connected to  $V_{CC}$  pin, as shown in Figure 17. This internal high-voltage current source is enabled until  $V_{CC}$  reaches  $V_{START}$  (12 V). During steady-state operation, this internal high-voltage regulator ( $HV_{REG}$ ) maintains the  $V_{CC}$  with 10 V and provides operating switching current ( $I_{OPS}$ ) for all internal circuits. Therefore, FSL4110LR needs no external bias circuit. The high-voltage regulator is disabled when  $V_{CC}$  supplied by the external bias is higher than 10 V. However in the case of self-biasing, power consumption is increased.

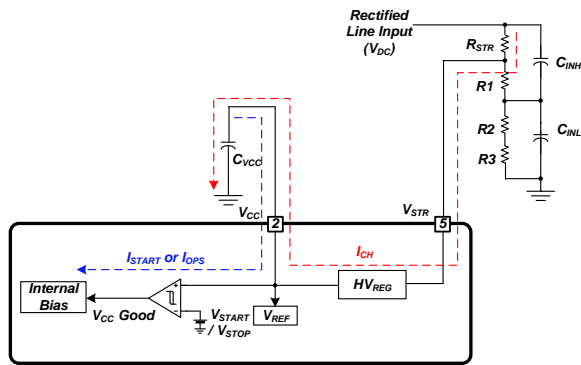


Figure 17. Startup and  $HV_{REG}$  Block

The startup resistor ( $R_{STR}$ ) can be calculated by the following equation (1).

$$R_{STR} \leq \frac{V_{DC\_MIN} - V_{START}}{I_{CH}} \quad (1)$$

where,  $I_{OPS} < I_{CH} < 2 \text{ mA}$ ,

$$R_{STR} + R1 = R2 + R3$$

### 2. Feedback Control

FSL4110LR employs current-mode control scheme. An opto-coupler (such as FOD817) and shunt regulator (such as KA431) in secondary-side are typically used to implement the feedback network. Comparing the feedback voltage with the voltage across  $R_{SENSE}$  resistor makes it possible to control the switching duty cycle. When the input voltage is increased or the output load is decreased, reference input voltage of shunt regulator is increased. If this voltage exceeds internal reference voltage of shunt regulator, opto-diode's current of the opto-coupler increases, pulling down the feedback voltage and reducing drain current.

#### 2.1. Pulse-by-Pulse Current Limit

Because current-mode control is employed, the peak current flowing through the SenseFET is limited by the inverting input of PWM comparator, as shown in Figure 18. Assuming that 100  $\mu\text{A}$  current source ( $I_{FB}$ ) flows only through the internal resistors ( $3R + R = 24 \text{ k}\Omega$ ), the cathode voltage of diode D2 is about 2.4 V. Since D1 is

blocked when feedback voltage ( $V_{FB}$ ) exceeds 2.4 V, the maximum voltage of the cathode of D2 is clamped at this voltage. Therefore, the peak value of the current of the SenseFET is limited at:

$$\frac{2.4V}{R_{SENSE}} \times \text{Sense Ratio} \quad (2)$$

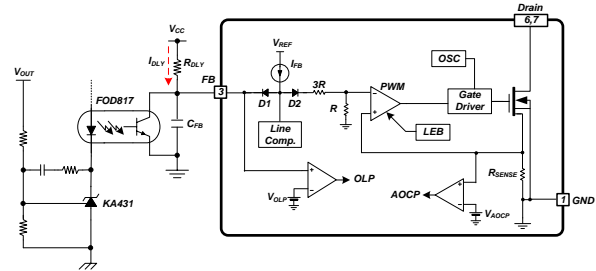


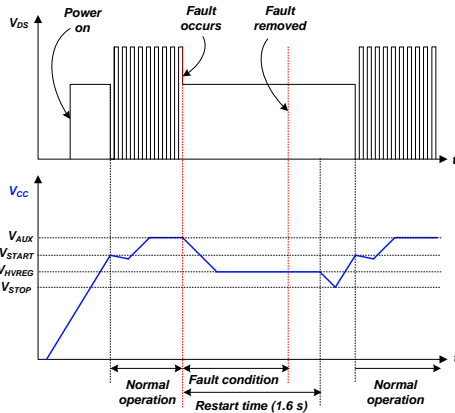
Figure 18. Pulse Width Modulation Circuit

### 2.2. Leading Edge Blanking (LEB)

At the instant, the internal SenseFET is turned on, a high-current spike usually occurs through the SenseFET, caused by primary-side capacitance and secondary-side rectifier reverse recovery. Excessive voltage across the  $R_{SENSE}$  resistor leads to incorrect feedback operation in the current-mode PWM control. To counter this effect, FSL4110LR employs a leading-edge blanking (LEB) circuit. This circuit inhibits the PWM comparator for  $t_{LEB}$  (250 ns) after the SenseFET is turned on.

### 3. Protection Circuits

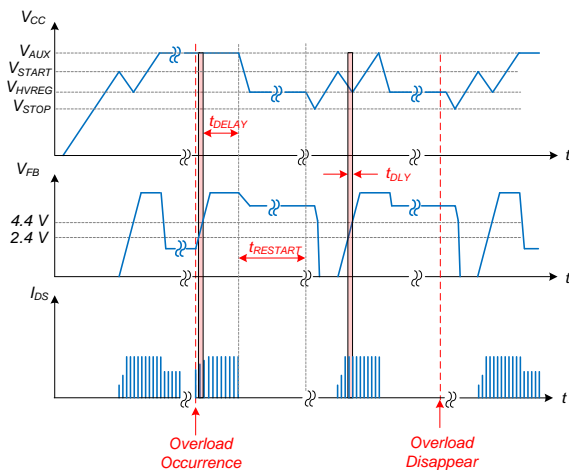
The protective functions include Overload Protection (OLP), Over-Voltage Protection (OVP), Under-Voltage Lockout (UVLO), Abnormal Over-Current Protection (AOCP), and Thermal Shutdown (TSD). All of the protections operate in auto-restart mode as shown in Figure 19. Since these protection circuits are fully integrated inside the IC without external components, reliability is improved without increasing cost and PCB space. If a fault condition occurs, switching is terminated and the SenseFET remains off. At the same time, internal protection timing control is activated to decrease power consumption and stress on passive and active components during auto-restart. When internal protection timing control is activated,  $V_{CC}$  is regulated with 10 V through the internal high-voltage regulator while switching is terminated. This internal protection timing control continues until restart time (1.6 s) duration is finished. After counting to 1.6 s, the internal high-voltage regulator is disabled and  $V_{CC}$  is decreased. When  $V_{CC}$  reaches the UVLO stop voltage,  $V_{STOP}$  (8 V), the protection is reset and the internal high-voltage current source charges the  $V_{CC}$  capacitor via the high voltage startup pin ( $V_{STR}$ ) again. When  $V_{CC}$  reaches the UVLO start voltage,  $V_{START}$  (12 V), the FSL4110LR resumes normal operation. In this manner, auto-restart function can alternately enable and disable the switching of the power SenseFET until the fault condition is eliminated.



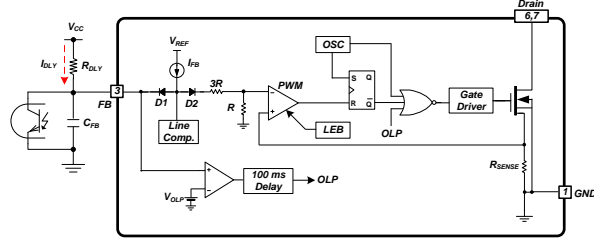
**Figure 19. Auto-Restart Protection Waveforms**

### 3.1. Overload Protection (OLP)

Overload is defined as the load current exceeding its normal level due to an unexpected abnormal event. In this situation, the protection circuit should trigger to protect the SMPS. However, even when the SMPS is in normal operation, the overload protection circuit can be triggered during load transition. To avoid this undesired operation, the overload protection circuit is designed to trigger only after a specified time to determine whether it is a transient situation or a true overload situation. Because of the pulse-by-pulse current-limit capability, the maximum peak current through the SenseFET is limited. If the output consumes more than this maximum power, the output voltage decreases below the set voltage. This reduces the current through the optodiode, which also reduces the optocoupler transistor current, thus increasing the feedback voltage ( $V_{FB}$ ). If  $V_{FB}$  exceeds 2.4 V, internal diode D1 is blocked and the current ( $I_{DLY}$ ) by  $R_{DLY}$  starts to charge  $C_{FB}$ . If feedback voltage reaches 4.4 V, internal fixed delay time ( $t_{DELAY}$ ) starts counting. If feedback voltage maintains over 4.4 V after  $t_{DELAY}$  (100 ms), the switching operation is terminated (see Figure 20). The internal OLP circuit is shown in Figure 21.



**Figure 20. OLP Waveforms**



**Figure 21. OLP Circuit**

Recommended the  $R_{DLY}$  value is less than 5 M $\Omega$  in self-biasing. The delay time ( $t_{DLY}$ ) can be calculated by equation (3).

$$t_{DLY} = -R_{DLY} \times C_{FB} \times \ln \left( 1 - \frac{2}{V_{CC} - 2.4} \right) \quad (3)$$

Example:

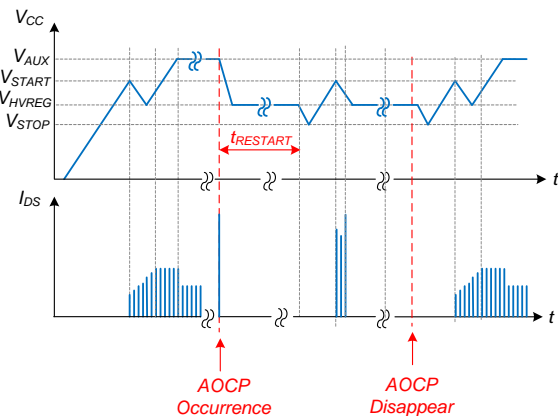
When,  $R_{DLY} = 3 \text{ M}\Omega$ ,  $C_{FB} = 68 \text{ nF}$ ,  $V_{CC} = 15 \text{ V}$ ,

$$t_{DLY} = 35 \text{ ms}$$

$\therefore$  Total delay time for OLP: 135 ms

### 3.2. Abnormal Over-Current Protection (AOCP)

When the secondary rectifier diodes or the transformer pins are shorted, a steep current with extremely high di/dt can flow through the SenseFET during the minimum turn-on time. Overload protection is not enough to protect the FSL4110LR in that abnormal case (see Figure 22); since severe current stress is imposed on the SenseFET until OLP is triggered. The internal AOCP circuit is shown in Figure 23. When the gate turn-on signal is applied to the power SenseFET, the AOCP block is enabled and monitors the current through the sensing-resistor. The voltage across the resistor is compared with a preset AOCP level. If the sensing resistor voltage is greater than the AOCP level, the high signal is applied to input of the NOR gate, resulting in the shutdown of the SMPS.



**Figure 22. AOCP Waveforms**

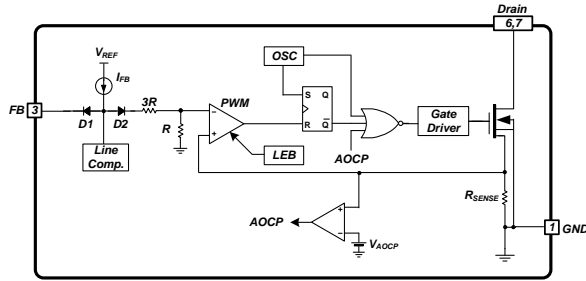


Figure 23. AOCp Circuit

### 3.3. Over-Voltage Protection (OVP)

If the secondary-side feedback circuit malfunctions or a solder defect causes an opening in the feedback path, the current through the opto-coupler transistor becomes almost zero. Then  $V_{FB}$  climbs in a similar manner to the overload situation, forcing the preset maximum drain current to flow until the overload protection is triggered. Because more energy than required is provided to the output, the output voltage may exceed the rated voltage before the overload protection is triggered, resulting in the breakdown of the devices in the secondary side. To prevent this situation, an OVP circuit is employed. In general, the  $V_{CC}$  is proportional to the output voltage when the bias-winding is used and the FSL4110LR uses  $V_{CC}$  instead of directly monitoring the output voltage. If  $V_{CC}$  exceeds 24.5 V, an OVP circuit is triggered, resulting in the termination of the switching operation. To avoid undesired activation of OVP during normal operation,  $V_{CC}$  should be designed to be below 24.5 V in the normal conditions. The internal OVP circuit is shown in Figure 24.

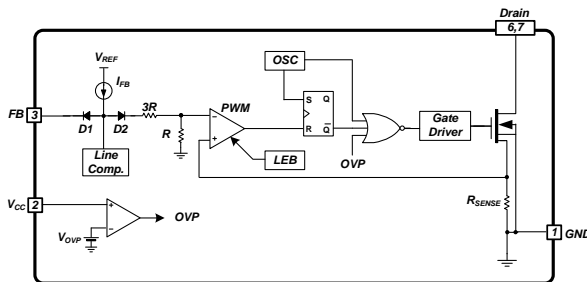


Figure 24. OVP Circuit

### 3.4. Thermal Shutdown (TSD)

The SenseFET and control IC integrated on the same package makes it easier to detect the temperature of the SenseFET. When the junction temperature exceeds 140°C, thermal shutdown is activated. The FSL4110LR is restarted when the temperature decreases by 60°C within  $t_{RESTART}$  (1.6 s).

### 3.5. Line Over-Voltage Protection (LOVP)

If the line input voltage is increased to an undesirable level, high line input voltage creates high-voltage stress on the entire system. To protect the SMPS from this abnormal condition, LOVP is included. It is comprised of detecting  $V_{IN}$  voltage by using divided resistors. When voltage of  $V_{IN}$  voltage is higher than 2.0 V, this condition is recognized as an abnormal error and PWM switching shuts down until voltage of  $V_{IN}$  voltage decreases to

around 1.9 V within  $t_{RESTART}$  (see Figure 25). The internal LOVP circuit is shown in Figure 26.

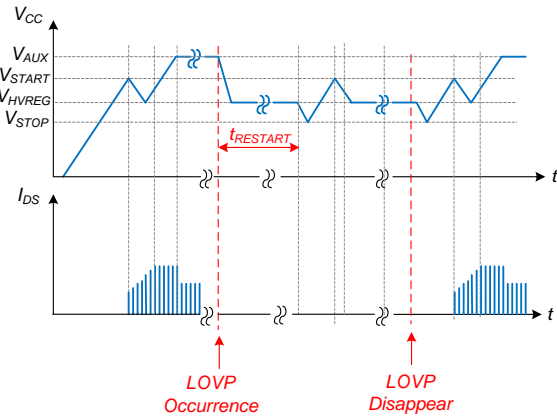


Figure 25. LOVP Waveforms

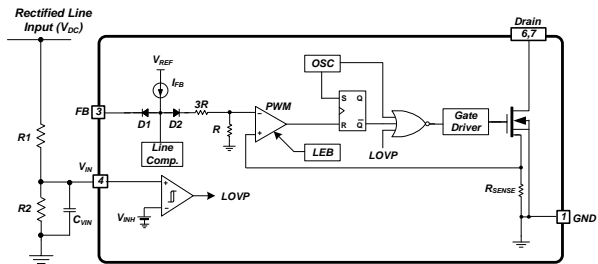


Figure 26. LOVP Circuit

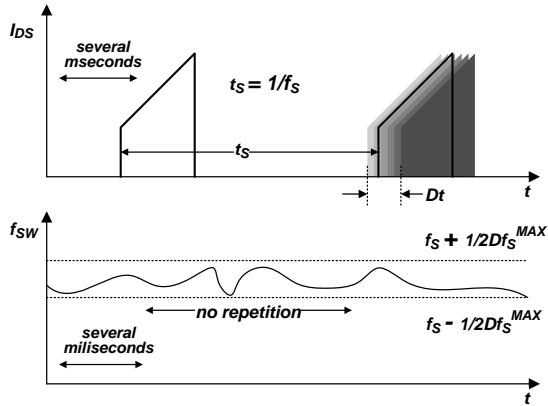
Equation (4) calculates the level of input over-voltage to RMS value.

$$R2 = \frac{V_{INH} \times R1}{V_{DC} - V_{INH}} \quad (4)$$

The resistance of divided resistor can be adjusted as necessary. Small resistance can bring relatively large stand-by power consumption at light-load condition. To avoid this situation, a several MΩ resistor is recommended. For stable operation, a several MΩ resistor should accompany a capacitor ( $C_{VIN}$ ) with hundreds of pF capacitance between the  $V_{IN}$  pin and GND.

## 4. Oscillator Block

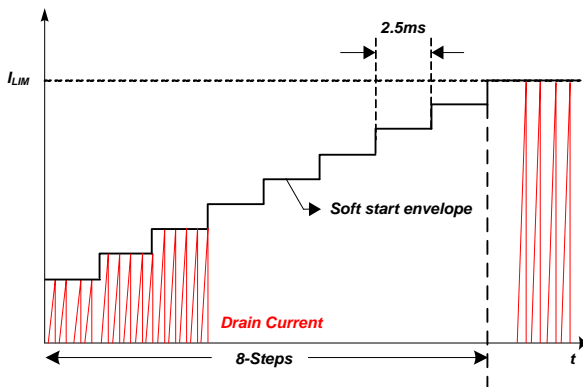
The oscillator frequency is set internally and the FSL4110LR has a random frequency fluctuation function as shown in Figure 27. Fluctuation of the switching frequency can reduce EMI by spreading the energy over a wider frequency range than the bandwidth measured by the EMI test equipment. The range of frequency variation is fixed internally; however, its selection is randomly chosen by the combination of an external feedback voltage and an internal free-running oscillator. This randomly chosen switching frequency effectively spreads the EMI noise near switching frequency and allows the use of a cost-effective inductor instead of an AC input line filter to satisfy world-wide EMI requirements.



**Figure 27. Frequency Fluctuation Waveforms**

### 5. Soft-Start

The internal soft-start circuit slowly increases the SenseFET current after it starts. The typical soft-start time is 20 ms, as shown in Figure 28, where progressive increments of the SenseFET current are allowed during startup. The pulse width to the power switching device is progressively increased to establish the correct working conditions for transformers, inductors, and capacitors. The voltage on the output capacitors is gradually increased to smoothly establish the required output voltage. Soft-start also helps to prevent transformer saturation and reduces stress on the secondary diode.

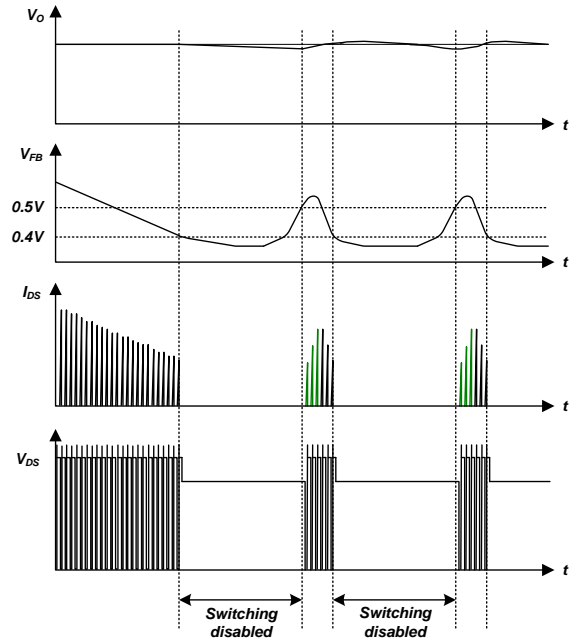


**Figure 28. Internal Soft-Start**

### 6. Burst Mode Operation

To minimize power dissipation in standby mode, the FSL4110LR enters burst mode. As the load decreases, the feedback voltage decreases. The device automatically enters burst mode when the feedback voltage drops below  $V_{BURL}$  (400 mV), as shown in Figure 29. At this point, switching stops and the output voltages start to drop at a rate dependent on standby current load. This causes the feedback voltage to rise. Once it passes  $V_{BURH}$  (500 mV), switching resumes. Feedback voltage then falls and the process repeats. Burst Mode alternately enables and disables switching of the SenseFET, reducing switching loss in standby

mode. Additionally to reduce the audible noise soft-burst is implemented.

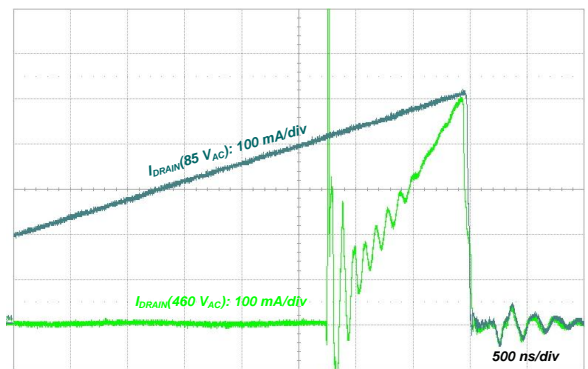


**Figure 29. Burst Mode Operation**

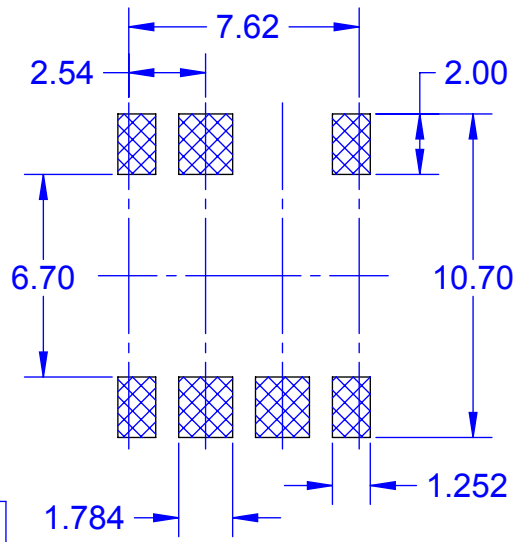
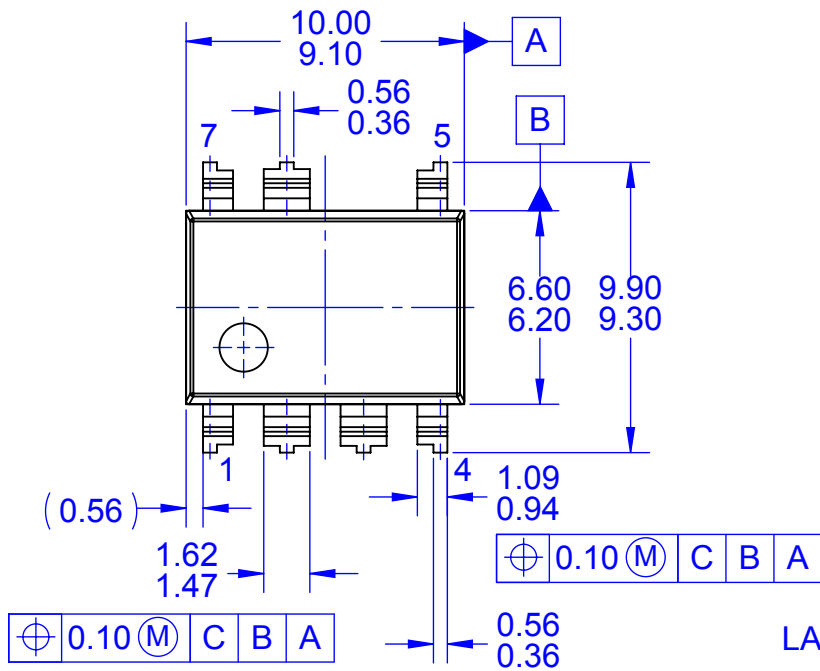
### 7. Line Compensation

All of switching devices have their own inherent propagation delays. This propagation delay will cause a current limit delay defined as  $t_{CLD}$ . Because there is a current limit delay,  $t_{CLD}$ , there is a difference in the current peak between low and high input voltage. The variance in the current peak is related to the difference between the input voltages, a wider gap in input voltage will result in a greater variance of the current peak.

In order to have a constant current peak regardless of the input voltage, line compensation is required. FSL4110LR has line compensation, so the real peak value of high input voltage is similar to that of low input voltage.  $t_{CLD}$  effect could be neglected as showed Figure 30.

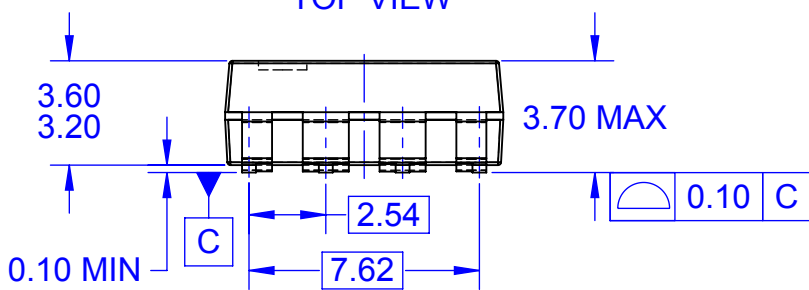


**Figure 30.  $I_{LIMIT}$  Waveforms (85 V<sub>AC</sub> vs. 460 V<sub>AC</sub>)**

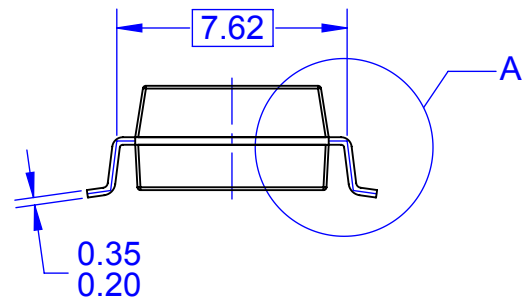


LAND PATTERN RECOMMENDATION

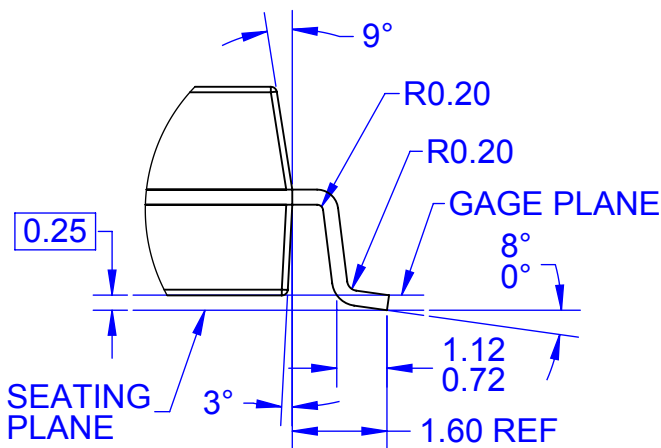
TOP VIEW



FRONT VIEW



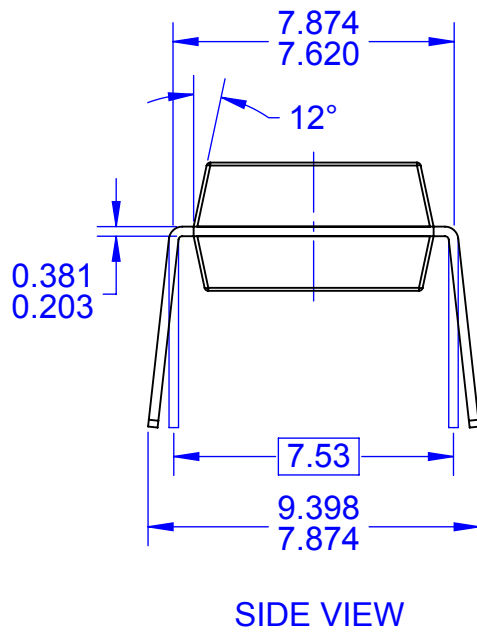
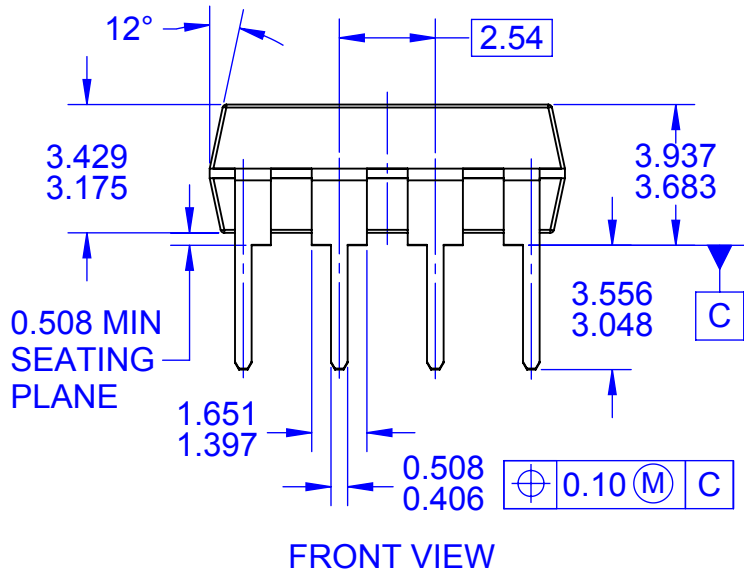
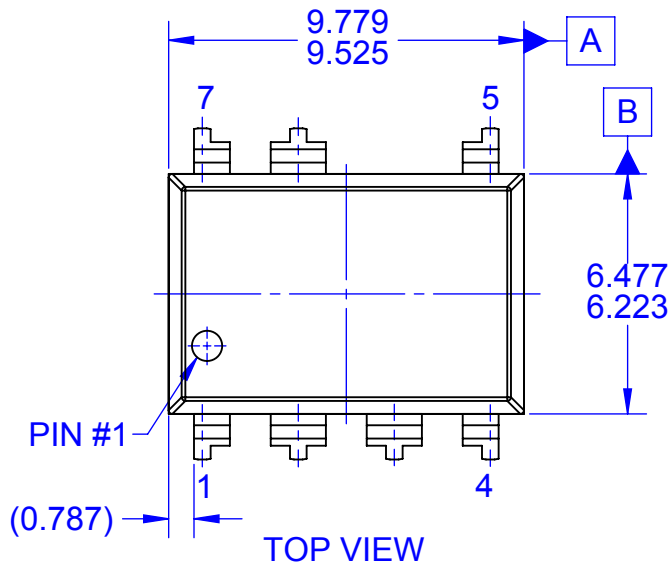
SIDE VIEW



DETAIL A  
SCALE 2:1

- NOTES: UNLESS OTHERWISE SPECIFIED  
 A. NO INDUSTRY STANDARD APPLIES TO THIS PACKAGE  
 B. ALL DIMENSIONS ARE IN MILLIMETERS  
 C. DIMENSIONS ARE EXCLUSIVE OF BURRS, MOLD FLASH, AND TIE BAR EXTRUSIONS  
 D. DIMENSIONS AND TOLERANCES PER ASME Y14.5M-2009  
 E. DRAWING FILENAME: MKT-MLSOP07Arev2





NOTES:

- A. REFERENCE JEDEC MS-001, VARIATION BA EXCEPT FOR NUMBER OF LEADS.
- B. DIMENSIONS ARE IN MILLIMETERS
- C. DIMENSIONS AND TOLERANCES PER ASME Y14.5M, 2009
- D. DIMENSIONS ARE EXCLUSIVE OF BURRS, MOLD FLASH AND TIE BAR EXTRUSIONS.
- E. DRAWING FILENAME: MKT-NA07Drev2



ON Semiconductor and  are trademarks of Semiconductor Components Industries, LLC dba ON Semiconductor or its subsidiaries in the United States and/or other countries. ON Semiconductor owns the rights to a number of patents, trademarks, copyrights, trade secrets, and other intellectual property. A listing of ON Semiconductor's product/patent coverage may be accessed at [www.onsemi.com/site/pdf/Patent-Marking.pdf](http://www.onsemi.com/site/pdf/Patent-Marking.pdf). ON Semiconductor reserves the right to make changes without further notice to any products herein. ON Semiconductor makes no warranty, representation or guarantee regarding the suitability of its products for any particular purpose, nor does ON Semiconductor assume any liability arising out of the application or use of any product or circuit, and specifically disclaims any and all liability, including without limitation special, consequential or incidental damages. Buyer is responsible for its products and applications using ON Semiconductor products, including compliance with all laws, regulations and safety requirements or standards, regardless of any support or applications information provided by ON Semiconductor. "Typical" parameters which may be provided in ON Semiconductor data sheets and/or specifications can and do vary in different applications and actual performance may vary over time. All operating parameters, including "Typicals" must be validated for each customer application by customer's technical experts. ON Semiconductor does not convey any license under its patent rights nor the rights of others. ON Semiconductor products are not designed, intended, or authorized for use as a critical component in life support systems or any FDA Class 3 medical devices or medical devices with a same or similar classification in a foreign jurisdiction or any devices intended for implantation in the human body. Should Buyer purchase or use ON Semiconductor products for any such unintended or unauthorized application, Buyer shall indemnify and hold ON Semiconductor and its officers, employees, subsidiaries, affiliates, and distributors harmless against all claims, costs, damages, and expenses, and reasonable attorney fees arising out of, directly or indirectly, any claim of personal injury or death associated with such unintended or unauthorized use, even if such claim alleges that ON Semiconductor was negligent regarding the design or manufacture of the part. ON Semiconductor is an Equal Opportunity/Affirmative Action Employer. This literature is subject to all applicable copyright laws and is not for resale in any manner.

## PUBLICATION ORDERING INFORMATION

### LITERATURE FULFILLMENT:

Literature Distribution Center for ON Semiconductor  
19521 E. 32nd Pkwy, Aurora, Colorado 80011 USA  
**Phone:** 303-675-2175 or 800-344-3860 Toll Free USA/Canada  
**Fax:** 303-675-2176 or 800-344-3867 Toll Free USA/Canada  
**Email:** [orderlit@onsemi.com](mailto:orderlit@onsemi.com)

**N. American Technical Support:** 800-282-9855 Toll Free  
USA/Canada  
**Europe, Middle East and Africa Technical Support:**  
Phone: 421 33 790 2910  
**Japan Customer Focus Center**  
Phone: 81-3-5817-1050

**ON Semiconductor Website:** [www.onsemi.com](http://www.onsemi.com)  
**Order Literature:** <http://www.onsemi.com/orderlit>  
For additional information, please contact your local  
Sales Representative