



Is Now Part of



**ON Semiconductor®**

To learn more about ON Semiconductor, please visit our website at  
[www.onsemi.com](http://www.onsemi.com)

ON Semiconductor and the ON Semiconductor logo are trademarks of Semiconductor Components Industries, LLC dba ON Semiconductor or its subsidiaries in the United States and/or other countries. ON Semiconductor owns the rights to a number of patents, trademarks, copyrights, trade secrets, and other intellectual property. A listing of ON Semiconductor's product/patent coverage may be accessed at [www.onsemi.com/site/pdf/Patent-Marking.pdf](http://www.onsemi.com/site/pdf/Patent-Marking.pdf). ON Semiconductor reserves the right to make changes without further notice to any products herein. ON Semiconductor makes no warranty, representation or guarantee regarding the suitability of its products for any particular purpose, nor does ON Semiconductor assume any liability arising out of the application or use of any product or circuit, and specifically disclaims any and all liability, including without limitation special, consequential or incidental damages. Buyer is responsible for its products and applications using ON Semiconductor products, including compliance with all laws, regulations and safety requirements or standards, regardless of any support or applications information provided by ON Semiconductor. "Typical" parameters which may be provided in ON Semiconductor data sheets and/or specifications can and do vary in different applications and actual performance may vary over time. All operating parameters, including "Typicals" must be validated for each customer application by customer's technical experts. ON Semiconductor does not convey any license under its patent rights nor the rights of others. ON Semiconductor products are not designed, intended, or authorized for use as a critical component in life support systems or any FDA Class 3 medical devices or medical devices with a same or similar classification in a foreign jurisdiction or any devices intended for implantation in the human body. Should Buyer purchase or use ON Semiconductor products for any such unintended or unauthorized application, Buyer shall indemnify and hold ON Semiconductor and its officers, employees, subsidiaries, affiliates, and distributors harmless against all claims, costs, damages, and expenses, and reasonable attorney fees arising out of, directly or indirectly, any claim of personal injury or death associated with such unintended or unauthorized use, even if such claim alleges that ON Semiconductor was negligent regarding the design or manufacture of the part. ON Semiconductor is an Equal Opportunity/Affirmative Action Employer. This literature is subject to all applicable copyright laws and is not for resale in any manner.



October 2014

# MPSA42 / MMBTA42 / PZTA42 NPN High-Voltage Amplifier

## Features

- This device is designed for application as a video output and other high-voltage applications.
- Sourced from process 48.

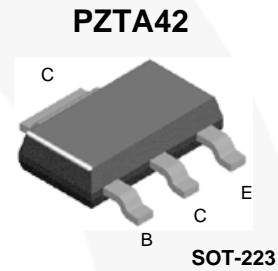
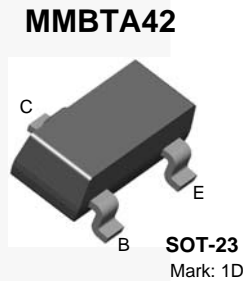
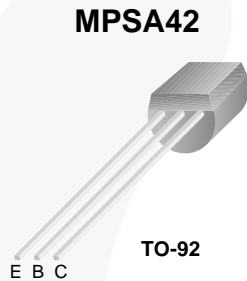

## Ordering Information

Part Number	Top Mark	Package	Packing Method
MPSA42	MPSA42	TO-92 3L	Bulk
MMBTA42	1D	SOT-23 3L	Tape and Reel
PZTA42	A42	SOT-223 4L	Tape and Reel

## Absolute Maximum Ratings<sup>(1), (2)</sup>

Stresses exceeding the absolute maximum ratings may damage the device. The device may not function or be operable above the recommended operating conditions and stressing the parts to these levels is not recommended. In addition, extended exposure to stresses above the recommended operating conditions may affect device reliability. The absolute maximum ratings are stress ratings only. Values are at  $T_A = 25^\circ\text{C}$  unless otherwise noted.

Symbol	Parameter	Value	Unit
$V_{CEO}$	Collector-Emitter Voltage	300	V
$V_{CBO}$	Collector-Base Voltage	300	V
$V_{EBO}$	Emitter-Base Voltage	6	V
$I_C$	Collector Current - Continuous	500	mA
$T_J, T_{STG}$	Operating and Storage Junction Temperature Range	-55 to +150	$^\circ\text{C}$

### Notes:

1. These ratings are based on a maximum junction temperature of  $150^\circ\text{C}$ .
2. These are steady-state limits. Fairchild Semiconductor should be consulted on applications involving pulsed or low-duty-cycle operations.

MPSA42 / MMBTA42 / PZTA42 — NPN High-Voltage Amplifier

## Thermal Characteristics

Values are at  $T_A = 25^\circ\text{C}$  unless otherwise noted.

Symbol	Parameter	Max.			Unit
		MPSA42	MMBTA42 <sup>(3)</sup>	PZTA42 <sup>(4)</sup>	
$P_D$	Total Device Dissipation	625	240	1000	mW
	Derate Above $25^\circ\text{C}$	5.00	1.92	8.00	mW/ $^\circ\text{C}$
$R_{\theta\text{JC}}$	Thermal Resistance, Junction-to-Case	83.3			$^\circ\text{C}/\text{W}$
$R_{\theta\text{JA}}$	Thermal Resistance, Junction-to-Ambient	200	515	125	$^\circ\text{C}/\text{W}$

### Notes:

- Device is mounted on FR-4 PCB 1.6 inch x 1.6 inch x 0.06 inch.
- Device is mounted on FR-4 PCB 36 mm x 18 mm x 1.5 mm, mounting pad for the collector lead minimum 6 cm<sup>2</sup>.

## Electrical Characteristics

Values are at  $T_A = 25^\circ\text{C}$  unless otherwise noted.

Symbol	Parameter	Conditions	Min.	Max.	Unit
<b>Off Characteristics</b>					
$V_{(\text{BR})\text{CEO}}$	Collector-Emitter Breakdown Voltage <sup>(5)</sup>	$I_C = 1.0 \text{ mA}, I_B = 0$	300		V
$V_{(\text{BR})\text{CBO}}$	Collector-Base Breakdown Voltage	$I_C = 100 \mu\text{A}, I_E = 0$	300		V
$V_{(\text{BR})\text{EBO}}$	Emitter-Base Breakdown Voltage	$I_E = 100 \mu\text{A}, I_C = 0$	6		V
$I_{\text{CBO}}$	Collector Cut-Off Current	$V_{\text{CB}} = 200 \text{ V}, I_E = 0$		0.1	$\mu\text{A}$
$I_{\text{EBO}}$	Emitter Cut-Off Current	$V_{\text{EB}} = 6 \text{ V}, I_C = 0$		0.1	$\mu\text{A}$
<b>On Characteristics<sup>(5)</sup></b>					
$h_{\text{FE}}$	DC Current Gain	$V_{\text{CE}} = 10 \text{ V}, I_C = 1.0 \text{ mA}$	25		
		$V_{\text{CE}} = 10 \text{ V}, I_C = 10 \text{ mA}$	40		
		$V_{\text{CE}} = 10 \text{ V}, I_C = 30 \text{ mA}$	40		
$V_{\text{CE(sat)}}$	Collector-Emitter Saturation Voltage	$I_C = 20 \text{ mA}, I_B = 2.0 \text{ mA}$		0.5	V
$V_{\text{BE(sat)}}$	Base-Emitter Saturation Voltage	$I_C = 20 \text{ mA}, I_B = 2.0 \text{ mA}$		0.9	V
<b>Small Signal Characteristics</b>					
$f_T$	Current Gain - Bandwidth Product	$I_C = 10 \text{ mA}, V_{\text{CE}} = 20 \text{ V}, f = 100 \text{ MHz}$	50		MHz
$C_{\text{cb}}$	Collector-Base Capacitance	$V_{\text{CB}} = 20 \text{ V}, I_E = 0, f = 1.0 \text{ MHz}$		3.0	pF

### Notes:

- Pulse test: pulse width  $\leq 300 \mu\text{s}$ , duty cycle  $\leq 2\%$ .

## Typical Performance Characteristics

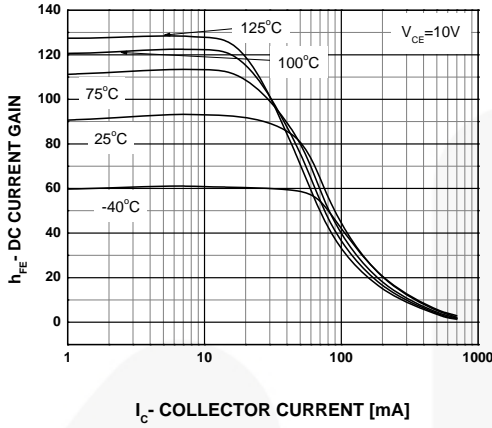

Figure 1. DC Current Gain vs. Collector Current

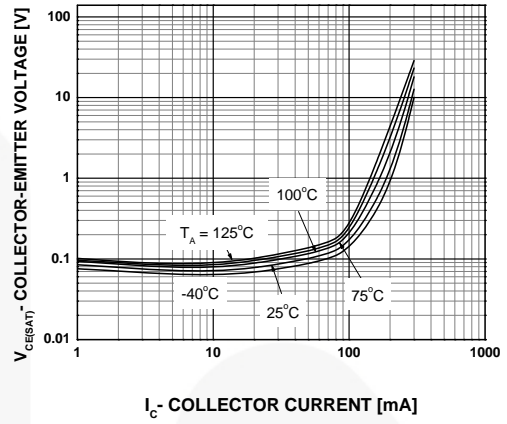

Figure 2. Collector-Emitter Saturation Voltage vs. Collector Current

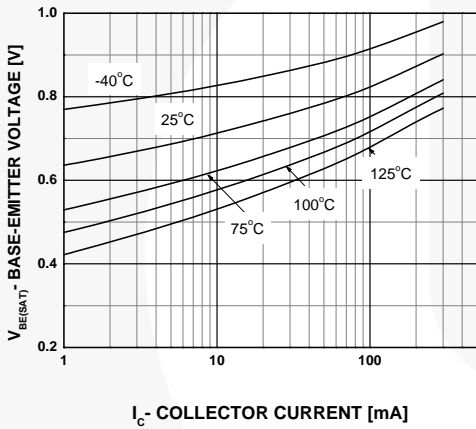

Figure 3. Base-Emitter Saturation Voltage vs. Collector Current

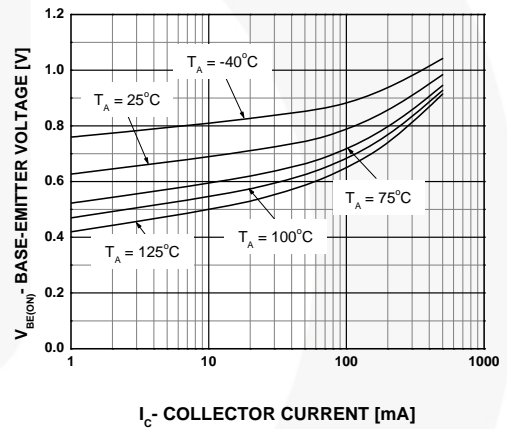

Figure 4. Base-Emitter On Voltage vs. Collector Current

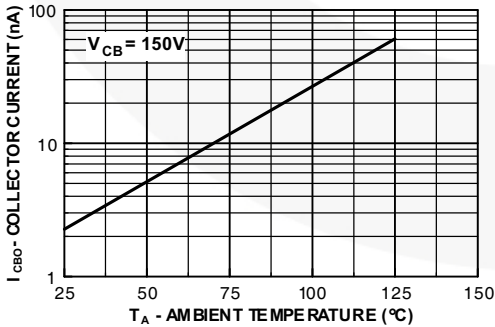

Figure 5. Collector Cut-Off Current vs. Ambient Temperature

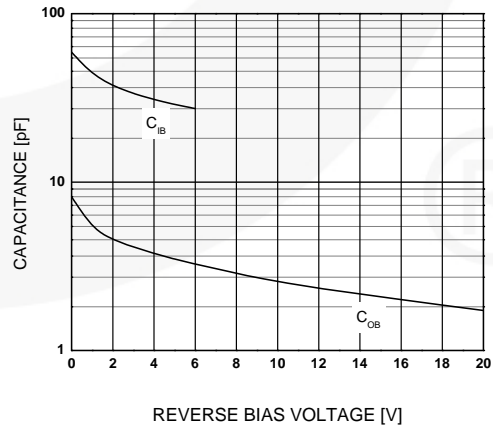

Figure 6. Collector-Base and Emitter-Base Capacitance vs. Reverse-Bias Voltage

### Typical Performance Characteristics (Continued)

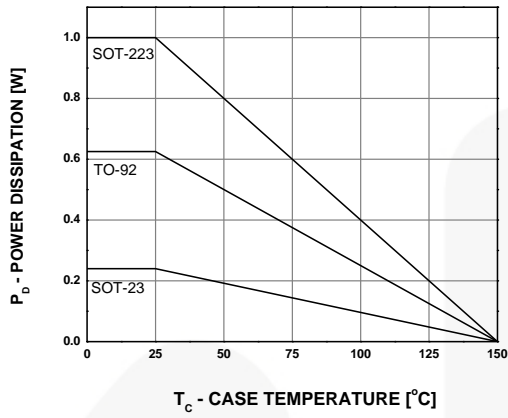
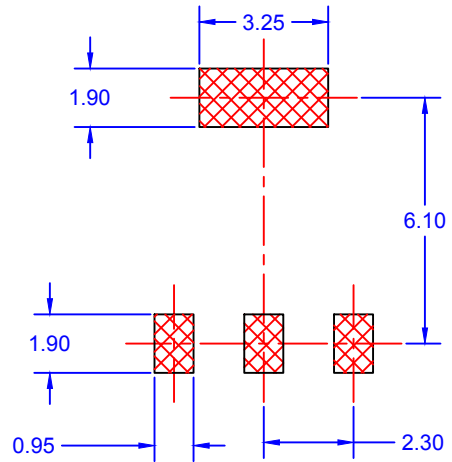
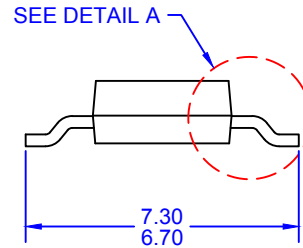
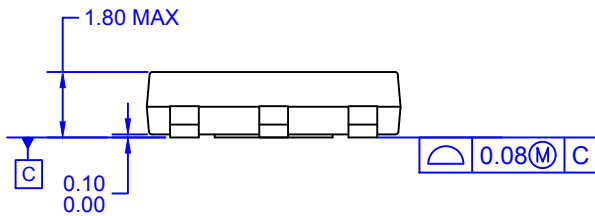

Figure 7. Power Dissipation vs. Ambient Temperature





LAND PATTERN RECOMMENDATION



- NOTES: UNLESS OTHERWISE SPECIFIED  
 A) DRAWING BASED ON JEDEC REGISTRATION TO-261C, VARIATION AA.  
 B) ALL DIMENSIONS ARE IN MILLIMETERS.  
 C) DIMENSIONS DO NOT INCLUDE BURRS OR MOLD FLASH. MOLD FLASH OR BURRS DOES NOT EXCEED 0.10MM.  
 D) DIMENSIONING AND TOLERANCING PER ASME Y14.5M-2009.  
 E) LANDPATTERN NAME: SOT230P700X180-4BN  
 F) DRAWING FILENAME: MKT-MA04AREV3

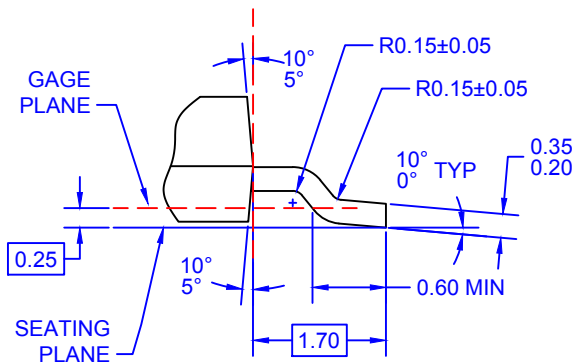

DETAIL A  
 SCALE: 2:1



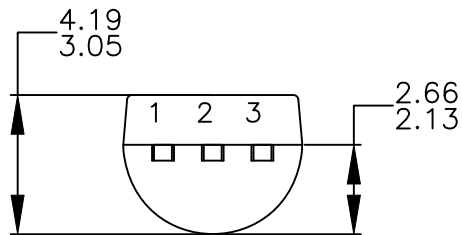
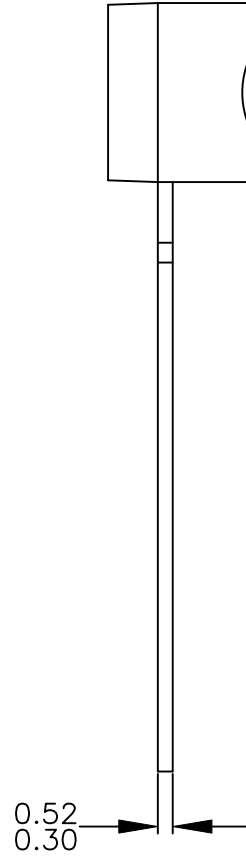
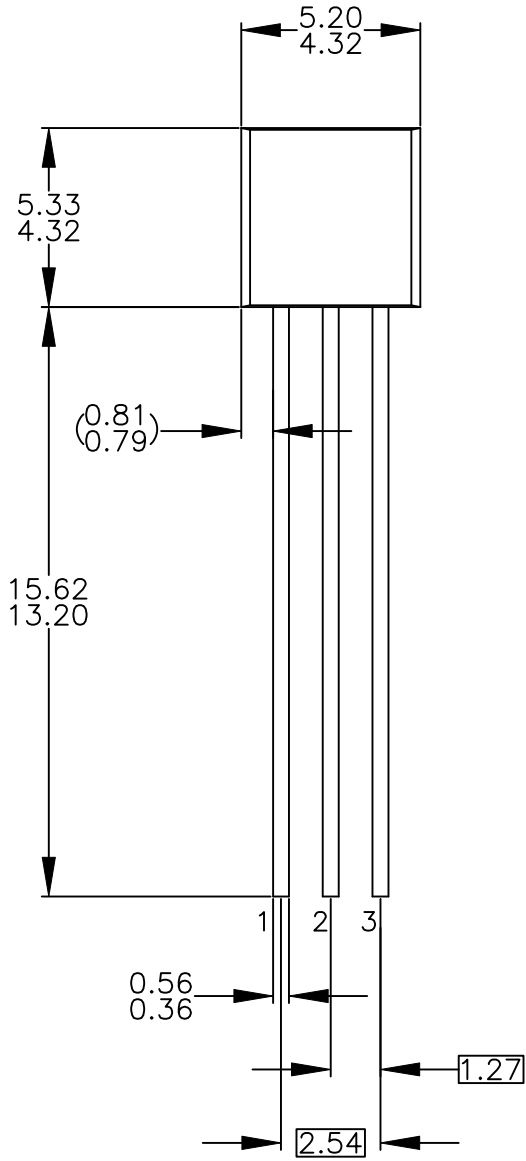

NOTES: UNLESS OTHERWISE SPECIFIED

- A) DRAWING WITH REFERENCE TO JEDEC TO-92 RECOMMENDATIONS.
- B) ALL DIMENSIONS ARE IN MILLIMETERS.
- C) DRAWING CONFORMS TO ASME Y14.5M-2009.
- D) DRAWING FILENAME: MKT-ZA03DREV4.



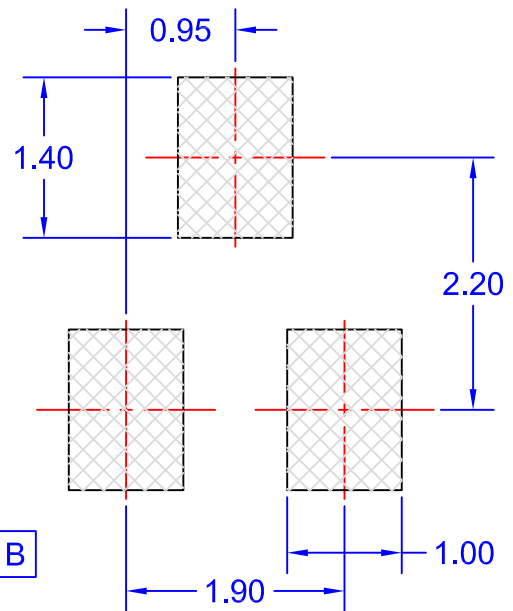
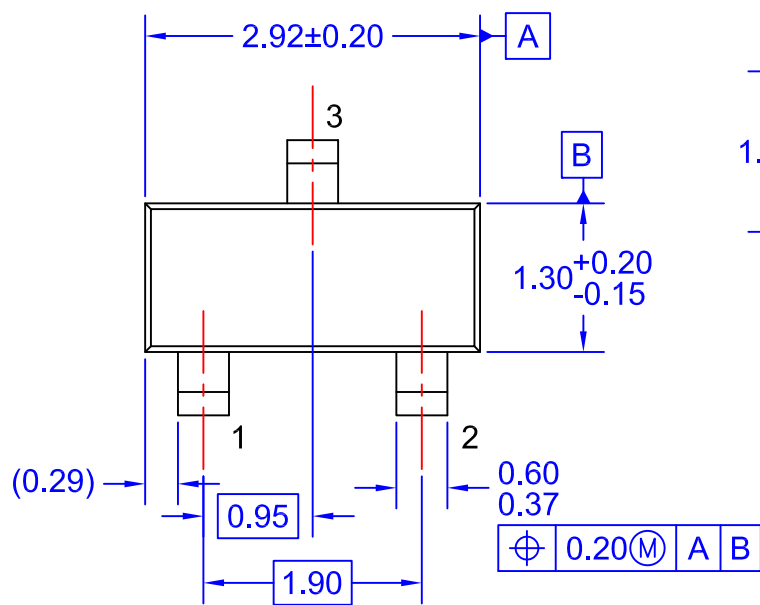

LAND PATTERN  
RECOMMENDATION

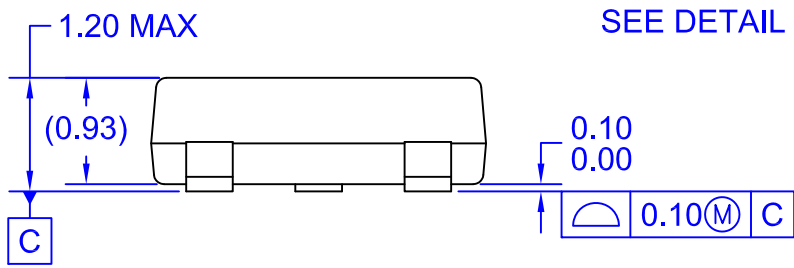

SEE DETAIL A

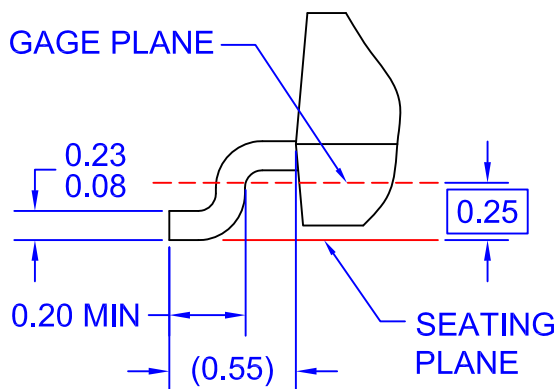
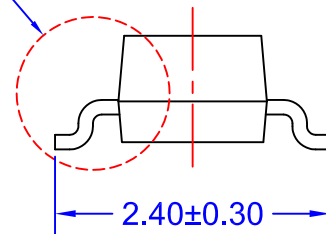

**DETAIL A**  
SCALE: 2X

NOTES: UNLESS OTHERWISE SPECIFIED

- A) REFERENCE JEDEC REGISTRATION TO-236, VARIATION AB, ISSUE H.
- B) ALL DIMENSIONS ARE IN MILLIMETERS.
- C) DIMENSIONS ARE INCLUSIVE OF BURRS, MOLD FLASH AND TIE BAR EXTRUSIONS.
- D) DIMENSIONING AND TOLERANCING PER ASME Y14.5M - 2009.
- E) DRAWING FILE NAME: MA03DREV12





ON Semiconductor and  are trademarks of Semiconductor Components Industries, LLC dba ON Semiconductor or its subsidiaries in the United States and/or other countries. ON Semiconductor owns the rights to a number of patents, trademarks, copyrights, trade secrets, and other intellectual property. A listing of ON Semiconductor's product/patent coverage may be accessed at [www.onsemi.com/site/pdf/Patent-Marking.pdf](http://www.onsemi.com/site/pdf/Patent-Marking.pdf). ON Semiconductor reserves the right to make changes without further notice to any products herein. ON Semiconductor makes no warranty, representation or guarantee regarding the suitability of its products for any particular purpose, nor does ON Semiconductor assume any liability arising out of the application or use of any product or circuit, and specifically disclaims any and all liability, including without limitation special, consequential or incidental damages. Buyer is responsible for its products and applications using ON Semiconductor products, including compliance with all laws, regulations and safety requirements or standards, regardless of any support or applications information provided by ON Semiconductor. "Typical" parameters which may be provided in ON Semiconductor data sheets and/or specifications can and do vary in different applications and actual performance may vary over time. All operating parameters, including "Typicals" must be validated for each customer application by customer's technical experts. ON Semiconductor does not convey any license under its patent rights nor the rights of others. ON Semiconductor products are not designed, intended, or authorized for use as a critical component in life support systems or any FDA Class 3 medical devices or medical devices with a same or similar classification in a foreign jurisdiction or any devices intended for implantation in the human body. Should Buyer purchase or use ON Semiconductor products for any such unintended or unauthorized application, Buyer shall indemnify and hold ON Semiconductor and its officers, employees, subsidiaries, affiliates, and distributors harmless against all claims, costs, damages, and expenses, and reasonable attorney fees arising out of, directly or indirectly, any claim of personal injury or death associated with such unintended or unauthorized use, even if such claim alleges that ON Semiconductor was negligent regarding the design or manufacture of the part. ON Semiconductor is an Equal Opportunity/Affirmative Action Employer. This literature is subject to all applicable copyright laws and is not for resale in any manner.

## PUBLICATION ORDERING INFORMATION

### LITERATURE FULFILLMENT:

Literature Distribution Center for ON Semiconductor  
19521 E. 32nd Pkwy, Aurora, Colorado 80011 USA  
**Phone:** 303-675-2175 or 800-344-3860 Toll Free USA/Canada  
**Fax:** 303-675-2176 or 800-344-3867 Toll Free USA/Canada  
**Email:** [orderlit@onsemi.com](mailto:orderlit@onsemi.com)

**N. American Technical Support:** 800-282-9855 Toll Free  
USA/Canada  
**Europe, Middle East and Africa Technical Support:**  
Phone: 421 33 790 2910  
**Japan Customer Focus Center**  
Phone: 81-3-5817-1050

**ON Semiconductor Website:** [www.onsemi.com](http://www.onsemi.com)  
**Order Literature:** <http://www.onsemi.com/orderlit>  
For additional information, please contact your local  
Sales Representative