



Is Now Part of



ON Semiconductor®

To learn more about ON Semiconductor, please visit our website at
www.onsemi.com

ON Semiconductor and the ON Semiconductor logo are trademarks of Semiconductor Components Industries, LLC dba ON Semiconductor or its subsidiaries in the United States and/or other countries. ON Semiconductor owns the rights to a number of patents, trademarks, copyrights, trade secrets, and other intellectual property. A listing of ON Semiconductor's product/patent coverage may be accessed at www.onsemi.com/site/pdf/Patent-Marking.pdf. ON Semiconductor reserves the right to make changes without further notice to any products herein. ON Semiconductor makes no warranty, representation or guarantee regarding the suitability of its products for any particular purpose, nor does ON Semiconductor assume any liability arising out of the application or use of any product or circuit, and specifically disclaims any and all liability, including without limitation special, consequential or incidental damages. Buyer is responsible for its products and applications using ON Semiconductor products, including compliance with all laws, regulations and safety requirements or standards, regardless of any support or applications information provided by ON Semiconductor. "Typical" parameters which may be provided in ON Semiconductor data sheets and/or specifications can and do vary in different applications and actual performance may vary over time. All operating parameters, including "Typicals" must be validated for each customer application by customer's technical experts. ON Semiconductor does not convey any license under its patent rights nor the rights of others. ON Semiconductor products are not designed, intended, or authorized for use as a critical component in life support systems or any FDA Class 3 medical devices or medical devices with a same or similar classification in a foreign jurisdiction or any devices intended for implantation in the human body. Should Buyer purchase or use ON Semiconductor products for any such unintended or unauthorized application, Buyer shall indemnify and hold ON Semiconductor and its officers, employees, subsidiaries, affiliates, and distributors harmless against all claims, costs, damages, and expenses, and reasonable attorney fees arising out of, directly or indirectly, any claim of personal injury or death associated with such unintended or unauthorized use, even if such claim alleges that ON Semiconductor was negligent regarding the design or manufacture of the part. ON Semiconductor is an Equal Opportunity/Affirmative Action Employer. This literature is subject to all applicable copyright laws and is not for resale in any manner.

FMS6143

Low-Cost Three-Channel 4th-Order Standard Definition Video Filter Driver

Features

- Three 4th-order 8MHz (SD) filters
- Drives single, AC- or DC-coupled, video loads ($2V_{pp}$, 150Ω)
- Drives dual, AC- or DC-coupled, video loads ($2V_{pp}$, 75Ω)
- Transparent input clamping
- AC- or DC-coupled inputs
- AC- or DC-coupled outputs
- DC-coupled outputs eliminate AC-coupling capacitors
- 5V only
- Robust 8kV ESD protection
- Lead-free SOIC-8 package

Applications

- Cable set-top boxes
- Satellite set-top boxes
- DVD players
- HDTV
- Personal Video Recorders (PVR)
- Video On Demand (VOD)

Description

The FMS6143 Low-Cost Video Filter (LCVF) is intended to replace passive LC filters and drivers with a low-cost integrated device. Three 4th-order filters provide improved image quality compared to typical 2nd or 3rd-order passive solutions.

The FMS6143 may be directly driven by a DC-coupled DAC output or an AC-coupled signal. Internal diode clamps and bias circuitry may be used if AC-coupled inputs are required (see *Applications* section for details).

The outputs can drive AC- or DC-coupled single (150Ω) or dual (75Ω) loads. DC-coupling the outputs removes the need for output coupling capacitors. The input DC-levels are offset approximately $+280mV$ at the output (see the *Applications* section for details).

Related Application Notes

[AN-8002 — FMS6418B 4:2:2 Application Note](#)

[AN-6024 — FMS6xxx Product Series Understanding Analog Video Signal Clamps, Bias, DC-Restore, and AC or DC Coupling Methods](#)

[AN-6041 — PCB Layout Considerations for Video Filter / Drivers](#)

Functional Block Diagram

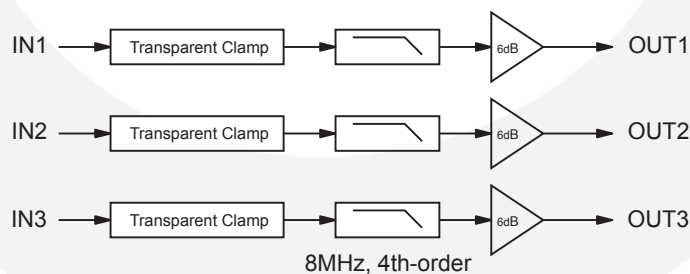

Figure 1. AC-Coupled Inputs and Outputs

Ordering Information

Part Number	Operating Temperature Range	Eco Status	Package	Packaging Method
FMS6143CSX	-40 to +85°C	RoHS	SOIC-8	Tape and Reel

For Fairchild's definition of Eco Status, please visit: http://www.fairchildsemi.com/company/green/rohs_green.html.

Pin Configuration

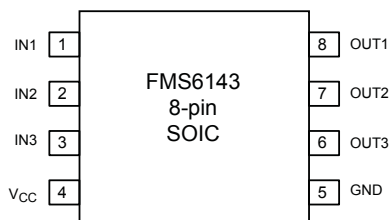

Figure 2. AC-Coupled Inputs and Outputs

Pin Assignments

Pin #	Name	Type	Description
1	IN1	Input	Video input, Channel 1
2	IN2	Input	Video input, Channel 2
3	IN3	Input	Video input, Channel 3
4	V _{CC}	Input	+5V supply, do not float
5	GND	Output	Must be tied to ground, do not float
6	OUT3	Output	Filtered output, Channel 3
7	OUT2	Output	Filtered output, Channel 2
8	OUT1	Output	Filtered output, Channel 1

Absolute Maximum Ratings

The “Absolute Maximum Ratings” are those values beyond which the safety of the device cannot be guaranteed. The device should not be operated at these limits. The parametric values defined in the Electrical Characteristics tables are not guaranteed at the absolute maximum ratings. The “Recommended Operating Conditions” table defines the conditions for actual device operation.

Symbol	Parameter	Min.	Max.	Unit
V_{CC}	DC Supply Voltage	-0.3	6.0	V
	Analog and Digital I/O	-0.3	$V_{CC} + 0.3$	V
	Output Channel - Any One Channel (Do Not Exceed)		50	mA

Note:

- Functional operation under any of these conditions is NOT implied. Performance and reliability are guaranteed only if operating conditions are not exceeded.

Reliability Information

Symbols	Parameter	Min.	Typ.	Max.	Unit
T_J	Junction Temperature			150	°C
T_{STG}	Storage Temperature Range	-65		+150	°C
T_L	Lead Temperature (Soldering, 10s)			+300	°C
θ_{JA}	Thermal Resistance, JEDEC Standard Multi-layer Test Boards, Still Air		115		°C/W

Electrostatic Discharge Information

Symbols	Parameter	Max.	Unit
ESD	Human Body Model, JESD22-A114	6.5	kV
	Charged Device Model, JESD22-C101	2.0	

Recommended Operating Conditions

The Recommended Operating Conditions table defines the conditions for actual device operation. Recommended operating conditions are specified to ensure optimal performance to the datasheet specifications. Fairchild does not recommend exceeding them or designing to absolute maximum ratings.

Symbols	Parameter	Min.	Typ.	Max.	Unit
T_A	Operating Temperature Range	-40		+85	°C
V_{CC}	V_{CC} Range	4.75	5.00	5.25	V

DC Electrical Characteristics

$T_A = 25^\circ\text{C}$, $V_{CC} = 5\text{V}$, $R_{SOURCE} = 37.5\Omega$; all inputs are AC-coupled with $0.1\mu\text{F}$; all outputs are AC-coupled with $220\mu\text{F}$ into 150Ω loads; unless otherwise noted.

Symbol	Parameter	Conditions	Min.	Typ.	Max.	Units
I_{CC}	Supply Current ⁽¹⁾	FMS6143 (No Load)		19	27	mA
V_{IN}	Video Input Voltage Range	Referenced to GND if DC-coupled		1.4		V_{pp}
PSRR	Power Supply Rejection	DC (All Channels)		-50		dB

AC Electrical Characteristics

$T_A = 25^\circ\text{C}$, $V_{IN} = 1V_{pp}$, $V_{CC} = 5\text{V}$, $R_{SOURCE} = 37.5\Omega$; all inputs are AC-coupled with $0.1\mu\text{F}$; all outputs are AC-coupled with $220\mu\text{F}$ into 150Ω loads; unless otherwise noted.

Symbol	Parameter	Conditions	Min.	Typ.	Max.	Units
AV	Channel Gain ⁽¹⁾	All Channels	6.0	6.2	6.4	dB
f_{1dB}	-1dB Bandwidth ⁽¹⁾	All Channels	5.6	6.5		MHz
f_C	-3dB Bandwidth	All Channels		7.7		MHz
f_{SB}	Attenuation (Stopband Reject)	All Channels at $f = 27\text{MHz}$		48		dB
DG	Differential Gain	All Channels		0.3		%
DP	Differential Phase	All Channels		0.6		°
THD	Output Distortion (All Channels)	$V_{OUT} = 1.8V_{pp}$, 1MHz		0.4		%
X_{TALK}	Crosstalk (Channel-to-Channel)	at 1MHz		-60		dB
SNR	Signal-to-Noise Ratio	All Channels, NTC-7 Weighting: 100kHz to 4.2MHz		75		dB
t_{pd}	Propagation Delay	Delay from Input-to-Output, 4.5MHz		59		ns

Note:

- 100% tested at 25°C .

Typical Performance Characteristics

$T_A = 25^\circ\text{C}$, $V_{CC} = 5\text{V}$, $R_{SOURCE} = 37.5\Omega$; all inputs AC-coupled with $0.1\mu\text{F}$; all outputs are AC-coupled with $220\mu\text{F}$ into 150Ω loads; unless otherwise noted.

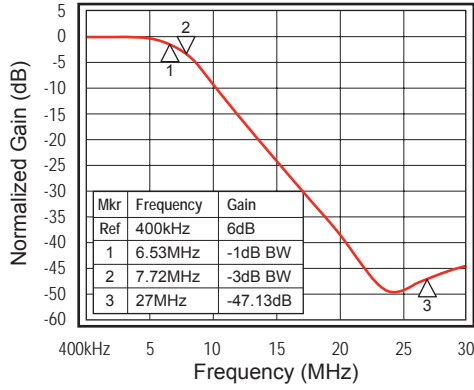

Figure 3. Frequency Response

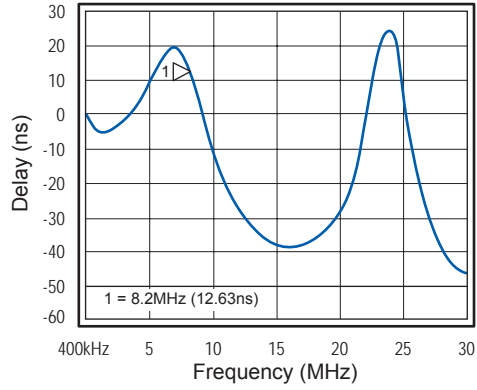

Figure 4. Group Delay vs. Frequency

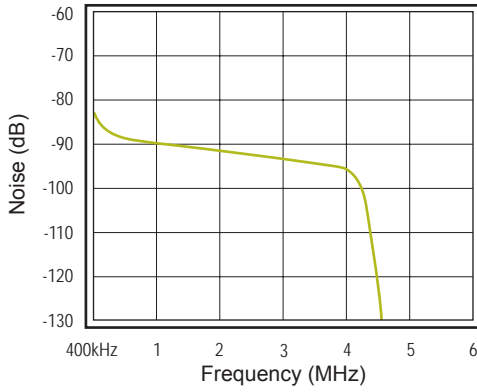

Figure 5. Noise vs. Frequency

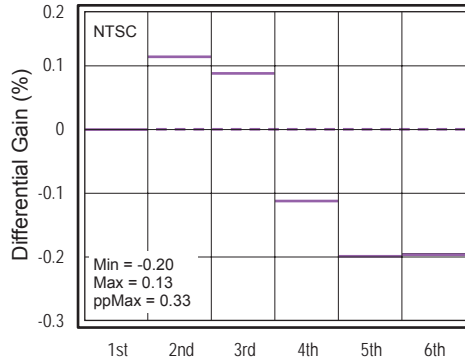

Figure 6. Differential Gain

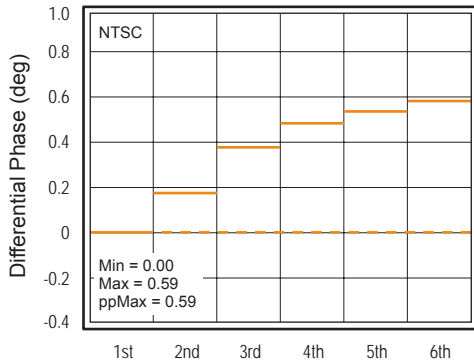

Figure 7. Differential Phase

Typical Application Diagrams

The following circuit may be used for direct DC-coupled drive by DACs with an output voltage range of 0V to 1.4V. AC-coupled or DC-coupled outputs may be used with AC-coupled outputs, offering slightly lower power dissipation.

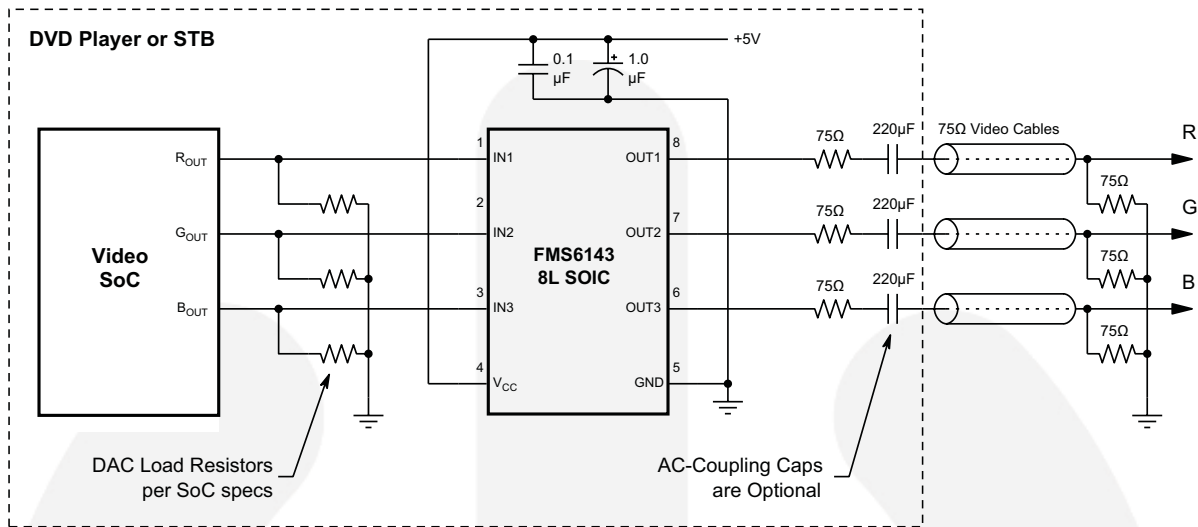
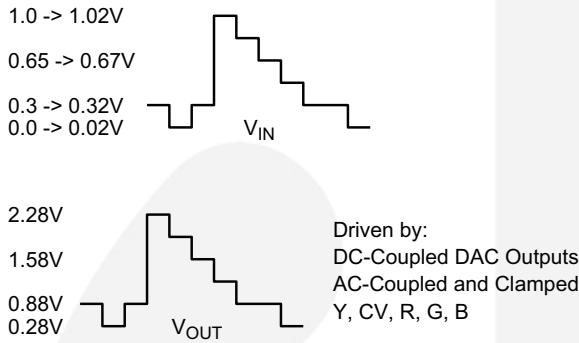

Figure 8. Typical Application Diagram

Application Information

Application Circuits

The FMS6143 Low Cost Video Filter (LCVF) provides 6dB gain from input to output. In addition, the input is slightly offset to optimize the output driver performance. The offset is held to the minimum required value to decrease the standing DC current into the load. Typical voltage levels are shown in the diagram below:



There is a 280mV offset from the DC input level to the DC output level. $V_{OUT} = 2 * V_{IN} + 280mV$.

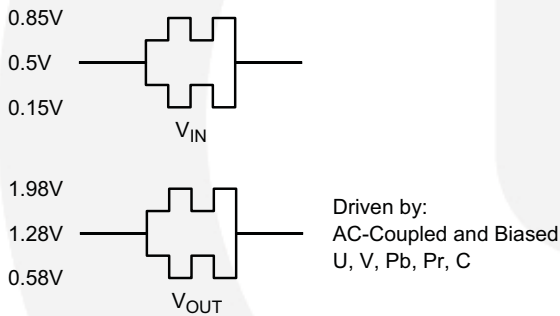

Figure 9. Typical Voltage Levels

The FMS6143 provides an internal diode clamp to support AC-coupled input signals. If the input signal does not go below ground, the input clamp does not operate. This allows DAC outputs to directly drive the FMS6143 without an AC coupling capacitor. When the input is AC-coupled, the diode clamp sets the sync tip (or lowest voltage) just below ground. The worst-case sync tip compression due to the clamp can not exceed 7mV. The input level set by the clamp, combined with the internal DC offset, keeps the output within its acceptable range.

For symmetric signals like Chroma, U, V, Pb, and Pr, the average DC bias is fairly constant and the inputs can be AC-coupled with the addition of a pull-up resistor to set the DC input voltage. DAC outputs can also drive these same signals without the AC coupling capacitor. A conceptual illustration of the input clamp circuit is shown in Figure 10:

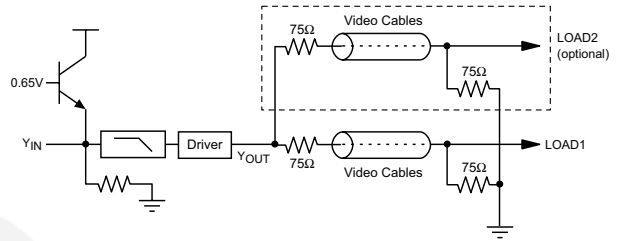

Figure 10. Input Clamp Circuit

I/O Configurations

For a DC-coupled DAC drive with DC-coupled outputs, use this configuration:

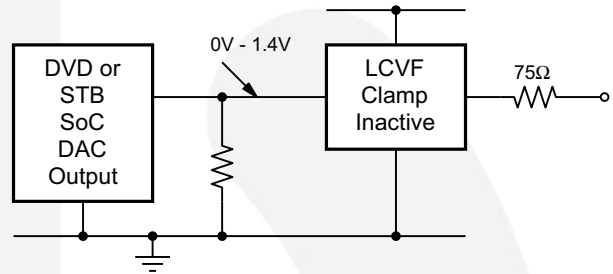

Figure 11. DC-Coupled Inputs and Outputs

Alternatively, if the DAC's average DC output level causes the signal to exceed the range of 0V to 1.4V, it can be AC coupled as follows:

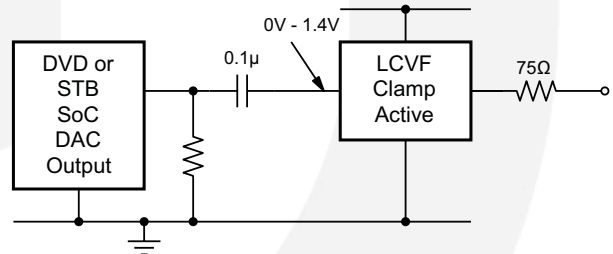

Figure 12. AC-Coupled Inputs, DC-Coupled Outputs

When the FMS6143 is driven by an unknown external source or a SCART switch with its own clamping circuitry, the inputs should be AC coupled like this:

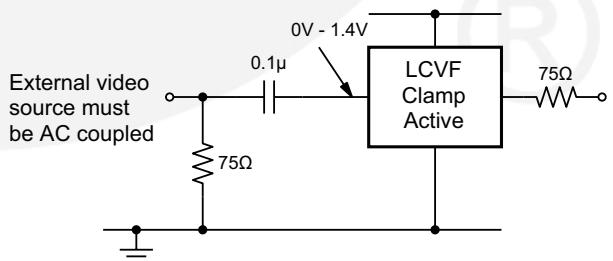

Figure 13. SCART with DC-Coupled Outputs

The same method can be used for biased signals, with the addition of a pull-up resistor to make sure the clamp never operates. The internal pull-down resistance is $800\text{k}\Omega \pm 20\%$, so the external resistance should be $7.5\text{M}\Omega$ to set the DC level to 500mV :

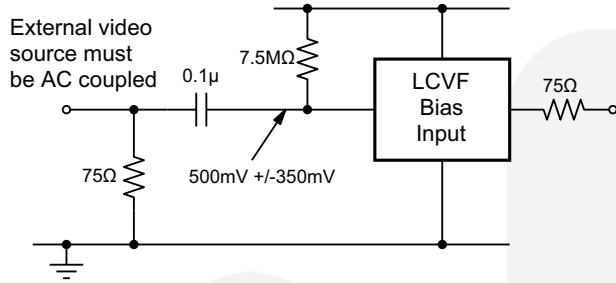

Figure 14. Biased SCART with DC-Coupled Outputs

The same circuits can be used with AC-coupled outputs if desired.

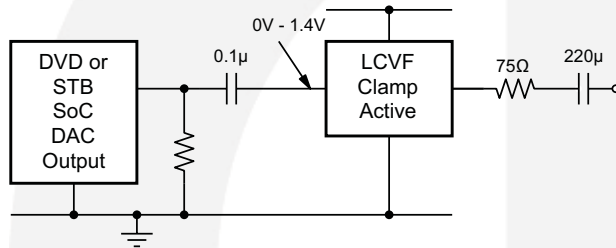

Figure 15. DC-Coupled Inputs, AC-Coupled Outputs

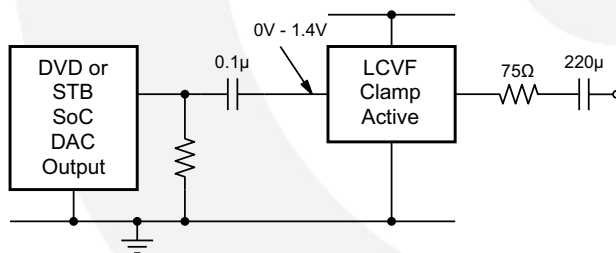

Figure 16. AC-Coupled Inputs and Outputs

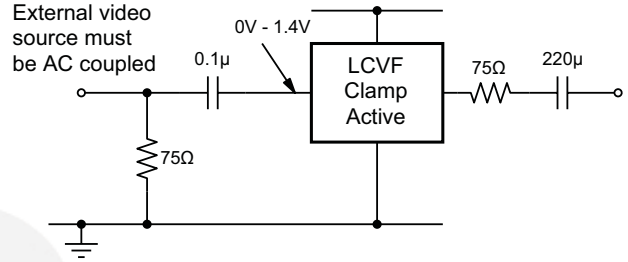

Figure 17. Biased SCART with AC-Coupled Outputs

NOTE: The video tilt or line time distortion is dominated by the AC-coupling capacitor. The value may need to be increased beyond $220\mu\text{F}$ to obtain satisfactory operation in some applications.

Power Dissipation

The FMS6143 output drive configuration must be considered when calculating overall power dissipation. Care must be taken not to exceed the maximum die junction temperature. The following example can be used to calculate the power dissipation and internal temperature rise.

$$T_J = T_A + P_d \cdot \theta_{JA} \quad (1)$$

$$\text{where: } P_d = P_{CH1} + P_{CH2} + P_{CH3} \text{ and} \quad (2)$$

$$P_{CHx} = V_{CC} \cdot I_{CH} - (V_O^2/R_L) \quad (3)$$

$$\text{where: } V_O = 2V_{IN} + 0.280V \quad (4)$$

$$I_{CH} = (I_{CC}/3) + (V_O/R_L) \quad (5)$$

V_{IN} = RMS value of input signal

$I_{CC} = 19\text{mA}$

$V_{CC} = 5V$

R_L = channel load resistance

Board layout can also affect thermal characteristics. Refer to the *Layout Considerations* section for details.

The FMS6143 is specified to operate with output currents typically less than 50mA , more than sufficient for a dual (75Ω) video load. Internal amplifiers are current limited to a maximum of 100mA and should withstand brief-duration short-circuit conditions. This capability is not guaranteed.

Layout Considerations

General layout and supply bypassing play a major role in high-frequency performance and thermal characteristics. Fairchild offers a demonstration board to guide layout and aid device evaluation. The demo board is a four-layer board with full power and ground planes. Following this layout configuration provides optimum performance and thermal characteristics for the device. For the best results, follow the steps and recommended routing rules listed below.

Recommended Routing/Layout Rules

- Do not run analog and digital signals in parallel.
- Use separate analog and digital power planes to supply power.
- Traces should run on top of the ground plane at all times.
- No trace should run over ground/power splits.
- Avoid routing at 90-degree angles.
- Minimize clock and video data trace length differences.
- Include 10 μ F and 0.1 μ F ceramic power supply bypass capacitors.
- Place the 0.1 μ F capacitor within 0.1 inches of the device power pin.
- Place the 10 μ F capacitor within 0.75 inches of the device power pin.
- For multi-layer boards, use a large ground plane to help dissipate heat.
- For two-layer boards, use a ground plane that extends beyond the device body at least 0.5 inches on all sides. Include a metal paddle under the device on the top layer.
- Minimize all trace lengths to reduce series inductance.

Thermal Considerations

Since the interior of most systems, such as set-top boxes, TVs, and DVD players, are at +70°C; consideration must be given to providing an adequate heat sink for the device package for maximum heat dissipation. When designing a system board, determine how much power each device dissipates. Ensure that devices of high power are not placed in the same location, such as directly above (top plane) or below (bottom plane), each other on the PCB.

PCB Thermal Layout Considerations

- Understand the system power requirements and environmental conditions.
- Maximize thermal performance of the PCB.

- Consider using 70 μ m of copper for high-power designs.
- Make the PCB as thin as possible by reducing FR4 thickness.
- Use vias in power pad to tie adjacent layers together.
- Remember that baseline temperature is a function of board area, not copper thickness.
- Modeling techniques provide a first-order approximation.

Output Considerations

The FMS6143 outputs are DC offset from the input by 150mV. Therefore, $V_{OUT} = 2 \cdot V_{IN} DC + 150mV$. This offset is required to obtain optimal performance from the output driver and is held at the minimum value to decrease the standing DC current into the load. Since the FMS6143 has a 2x (6dB) gain, the output is typically connected via a 75 Ω -series back-matching resistor, followed by the 75 Ω video cable. Due to the inherent divide by two of this configuration, the blanking level at the load of the video signal is always less than 1V. When AC-coupling the output, ensure that the coupling capacitor of choice passes the lowest frequency content in the video signal and that line time distortion (video tilt) is kept as low as possible.

The selection of the coupling capacitor is a function of the subsequent circuit input impedance and the leakage current of the input being driven. To obtain the highest quality output video signal, the series termination resistor must be placed as close to the output pin as possible. This reduces the parasitic capacitance and inductance effect on the output driver. The distance from the device pin to the series termination resistor should be no greater than 0.1 inches.



Figure 18. Distance from Device Pin to Series Termination Resistor



TRADEMARKS

The following includes registered and unregistered trademarks and service marks, owned by Fairchild Semiconductor and/or its global subsidiaries, and is not intended to be an exhaustive list of all such trademarks.

- | | | | |
|---|---|---|---|
| AccuPower™ | FPS™ | PowerTrench® | The Power Franchise® |
| Auto-SPM™ | F-PFS™ | PowerXS™ | the power franchise |
| Build it Now™ | FRFET® | Programmable Active Droop™ | TinyBoost™ |
| CorePLUS™ | Global Power Resource™ | QFET® | TinyBuck™ |
| CorePOWER™ | Green FPST™ | QS™ | TinyCalc™ |
| CROSSVOLT™ | Green FPST™ e-Series™ | Quiet Series™ | TinyLogic® |
| CTL™ | Gmax™ | RapidConfigure™ | TINYOPTO™ |
| Current Transfer Logic™ | GTO™ |  ™ | TinyPower™ |
| EcoSPARK® | IntelliMAX™ | Saving our world, 1mW/W/kW at a time™ | TinyPWM™ |
| EfficientMax™ | ISOPLANAR™ | SignalWise™ | TinyWire™ |
| EZSWITCH™ | MegaBuck™ | SmartMax™ | TriFault Detect™ |
|  ™ | MICROCOUPLER™ | SMART START™ | TRUECURRENT™ |
|  ™ | MicroFET™ | SPM® | μSerDes™ |
| Fairchild® | MicroPak™ | STEALTH™ |  ™ |
| Fairchild Semiconductor® | MillerDrive™ | SuperFET™ | UHC® |
| FACT Quiet Series™ | MotionMax™ | SuperSOT™.3 | Ultra FRFET™ |
| FACT® | Motion-SPM™ | SuperSOT™.6 | UniFET™ |
| FAST® | OPTOLOGIC® | SuperSOT™.8 | VCX™ |
| FAST® | OPTOPLANAR® | SupreMOS™ | VisualMax™ |
| FastvCore™ |  ™ | SyncFET™ | XS™ |
| FETBench™ | PDP SPM™ | Sync-Lock™ | |
| FlashWriter® | Power-SPM™ |  ™ | |

* Trademarks of System General Corporation, used under license by Fairchild Semiconductor.

DISCLAIMER

FAIRCHILD SEMICONDUCTOR RESERVES THE RIGHT TO MAKE CHANGES WITHOUT FURTHER NOTICE TO ANY PRODUCTS HEREIN TO IMPROVE RELIABILITY, FUNCTION, OR DESIGN. FAIRCHILD DOES NOT ASSUME ANY LIABILITY ARISING OUT OF THE APPLICATION OR USE OF ANY PRODUCT OR CIRCUIT DESCRIBED HEREIN; NEITHER DOES IT CONVEY ANY LICENSE UNDER ITS PATENT RIGHTS, NOR THE RIGHTS OF OTHERS. THESE SPECIFICATIONS DO NOT EXPAND THE TERMS OF FAIRCHILD'S WORLDWIDE TERMS AND CONDITIONS, SPECIFICALLY THE WARRANTY THEREIN, WHICH COVERS THESE PRODUCTS.

LIFE SUPPORT POLICY

FAIRCHILD'S PRODUCTS ARE NOT AUTHORIZED FOR USE AS CRITICAL COMPONENTS IN LIFE SUPPORT DEVICES OR SYSTEMS WITHOUT THE EXPRESS WRITTEN APPROVAL OF FAIRCHILD SEMICONDUCTOR CORPORATION.

As used herein:

1. Life support devices or systems are devices or systems which, (a) are intended for surgical implant into the body or (b) support or sustain life, and (c) whose failure to perform when properly used in accordance with instructions for use provided in the labeling, can be reasonably expected to result in a significant injury of the user.
2. A critical component in any component of a life support, device, or system whose failure to perform can be reasonably expected to cause the failure of the life support device or system, or to affect its safety or effectiveness.

ANTI-COUNTERFEITING POLICY

Fairchild Semiconductor Corporation's Anti-Counterfeiting Policy. Fairchild's Anti-Counterfeiting Policy is also stated on our external website, www.fairchildsemi.com, under Sales Support.

Counterfeiting of semiconductor parts is a growing problem in the industry. All manufacturers of semiconductor products are experiencing counterfeiting of their parts. Customers who inadvertently purchase counterfeit parts experience many problems such as loss of brand reputation, substandard performance, failed applications, and increased cost of production and manufacturing delays. Fairchild is taking strong measures to protect ourselves and our customers from the proliferation of counterfeit parts. Fairchild strongly encourages customers to purchase Fairchild parts either directly from Fairchild or from Authorized Fairchild Distributors who are listed by country on our web page cited above. Products customers buy either from Fairchild directly or from Authorized Fairchild Distributors are genuine parts, have full traceability, meet Fairchild's quality standards for handling and storage and provide access to Fairchild's full range of up-to-date technical and product information. Fairchild and our Authorized Distributors will stand behind all warranties and will appropriately address any warranty issues that may arise. Fairchild will not provide any warranty coverage or other assistance for parts bought from Unauthorized Sources. Fairchild is committed to combat this global problem and encourage our customers to do their part in stopping this practice by buying direct or from authorized distributors.

PRODUCT STATUS DEFINITIONS

Definition of Terms

Datasheet Identification	Product Status	Definition
Advance Information	Formative / In Design	Datasheet contains the design specifications for product development. Specifications may change in any manner without notice.
Preliminary	First Production	Datasheet contains preliminary data; supplementary data will be published at a later date. Fairchild Semiconductor reserves the right to make changes at any time without notice to improve design.
No Identification Needed	Full Production	Datasheet contains final specifications. Fairchild Semiconductor reserves the right to make changes at any time without notice to improve the design.
Obsolete	Not In Production	Datasheet contains specifications on a product that is discontinued by Fairchild Semiconductor. The datasheet is for reference information only.

Rev. 142

ON Semiconductor and  are trademarks of Semiconductor Components Industries, LLC dba ON Semiconductor or its subsidiaries in the United States and/or other countries. ON Semiconductor owns the rights to a number of patents, trademarks, copyrights, trade secrets, and other intellectual property. A listing of ON Semiconductor's product/patent coverage may be accessed at www.onsemi.com/site/pdf/Patent-Marking.pdf. ON Semiconductor reserves the right to make changes without further notice to any products herein. ON Semiconductor makes no warranty, representation or guarantee regarding the suitability of its products for any particular purpose, nor does ON Semiconductor assume any liability arising out of the application or use of any product or circuit, and specifically disclaims any and all liability, including without limitation special, consequential or incidental damages. Buyer is responsible for its products and applications using ON Semiconductor products, including compliance with all laws, regulations and safety requirements or standards, regardless of any support or applications information provided by ON Semiconductor. "Typical" parameters which may be provided in ON Semiconductor data sheets and/or specifications can and do vary in different applications and actual performance may vary over time. All operating parameters, including "Typicals" must be validated for each customer application by customer's technical experts. ON Semiconductor does not convey any license under its patent rights nor the rights of others. ON Semiconductor products are not designed, intended, or authorized for use as a critical component in life support systems or any FDA Class 3 medical devices or medical devices with a same or similar classification in a foreign jurisdiction or any devices intended for implantation in the human body. Should Buyer purchase or use ON Semiconductor products for any such unintended or unauthorized application, Buyer shall indemnify and hold ON Semiconductor and its officers, employees, subsidiaries, affiliates, and distributors harmless against all claims, costs, damages, and expenses, and reasonable attorney fees arising out of, directly or indirectly, any claim of personal injury or death associated with such unintended or unauthorized use, even if such claim alleges that ON Semiconductor was negligent regarding the design or manufacture of the part. ON Semiconductor is an Equal Opportunity/Affirmative Action Employer. This literature is subject to all applicable copyright laws and is not for resale in any manner.

PUBLICATION ORDERING INFORMATION

LITERATURE FULFILLMENT:

Literature Distribution Center for ON Semiconductor
19521 E. 32nd Pkwy, Aurora, Colorado 80011 USA
Phone: 303-675-2175 or 800-344-3860 Toll Free USA/Canada
Fax: 303-675-2176 or 800-344-3867 Toll Free USA/Canada
Email: orderlit@onsemi.com

N. American Technical Support: 800-282-9855 Toll Free
USA/Canada
Europe, Middle East and Africa Technical Support:
Phone: 421 33 790 2910
Japan Customer Focus Center
Phone: 81-3-5817-1050

ON Semiconductor Website: www.onsemi.com
Order Literature: <http://www.onsemi.com/orderlit>
For additional information, please contact your local
Sales Representative