

Printed-circuit board connector - DMC 1,5/12-G1F-3,5-LR P20THR - 1787111

Please be informed that the data shown in this PDF Document is generated from our Online Catalog. Please find the complete data in the user's documentation. Our General Terms of Use for Downloads are valid (<http://phoenixcontact.com/download>)

Header, Nominal current: 8 A, Rated voltage (III/2): 160 V, Number of positions: 12, Pitch: 3.5 mm, Color: black, Contact surface: Tin, Mounting: THR soldering



The figure shows a 10-pos. version with 20 contacts

Why buy this product

- Designed for integration into the SMT soldering process
- Screwable flange for superior mechanical stability
- Automatic locking and intuitive release through Lock and Release operating lever in contrasting color
- Conductor connection on several levels enables higher contact density
- Small component size for applications where space is at a premium



Key Commercial Data

Packing unit	50 STK
GTIN	 4 046356 596725
GTIN	4046356596725
Weight per Piece (excluding packing)	6.560 g
Custom tariff number	85366990
Country of origin	Germany

Technical data

Dimensions

Length	11.6 mm
Pitch	3.5 mm
Dimension a	38.5 mm
Width	49 mm
Constructional height	10.8 mm
Height	12.8 mm

Printed-circuit board connector - DMC 1,5/12-G1F-3,5-LR P20THR - 1787111

Technical data

Dimensions

Length of the solder pin	2 mm
Pin dimensions	0,8 x 0,8
Pin spacing	2.50 mm
Hole diameter	1.4 mm

General

Range of articles	DMC 1,5/...G1F-THR
Insulating material group	IIIa
Rated surge voltage (III/3)	2.5 kV
Rated surge voltage (III/2)	2.5 kV
Rated surge voltage (II/2)	2.5 kV
Rated voltage (III/3)	160 V
Rated voltage (III/2)	160 V
Rated voltage (II/2)	250 V
Connection in acc. with standard	EN-VDE
Nominal current I _N	8 A
Maximum load current	8 A
Insulating material	LCP
Flammability rating according to UL 94	V0
Color	black
Number of positions	12

Standards and Regulations

Connection in acc. with standard	EN-VDE
	CUL
Flammability rating according to UL 94	V0

Environmental Product Compliance

China RoHS	Environmentally friendly use period: unlimited = EFUP-e
	No hazardous substances above threshold values

Drawings

Printed-circuit board connector - DMC 1,5/12-G1F-3,5-LR P20THR - 1787111

Schematic diagram

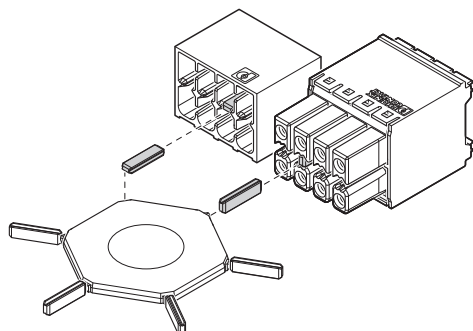

Drilling diagram

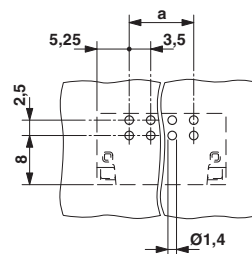

Use of the CP-DMC... coding profile

Diagram

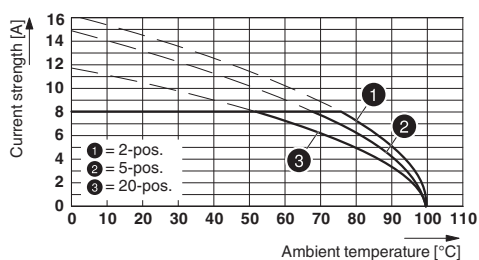

Dimensional drawing

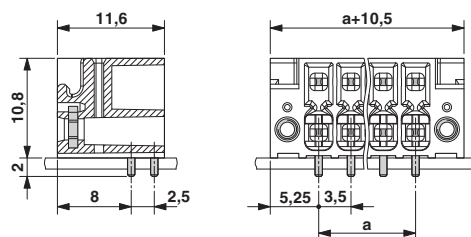

Type: DFMC 1,5/...-ST-3,5-LR with DMC 1,5/...-G1F-3,5-LR P20 THR

Schematic diagram

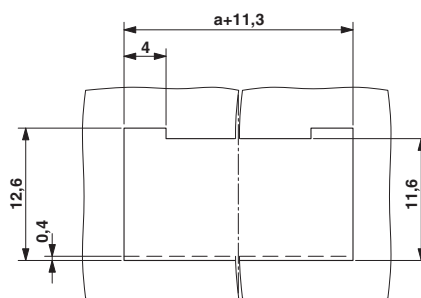

Panel cutout

Classifications

eCl@ss

eCl@ss 4.0	272607xx
eCl@ss 4.1	27260701
eCl@ss 5.0	27260701
eCl@ss 5.1	27260701
eCl@ss 6.0	27260704

Printed-circuit board connector - DMC 1,5/12-G1F-3,5-LR P20THR - 1787111

Classifications

eCl@ss

eCl@ss 7.0	27440402
eCl@ss 8.0	27440402
eCl@ss 9.0	27440402

ETIM

ETIM 4.0	EC002637
ETIM 5.0	EC002637
ETIM 6.0	EC002637

UNSPSC

UNSPSC 6.01	30211810
UNSPSC 7.0901	39121409
UNSPSC 11	39121409
UNSPSC 12.01	39121409
UNSPSC 13.2	39121409

Approvals

Approvals

Approvals

VDE Gutachten mit Fertigungsüberwachung / IECCE CB Scheme / cULus Recognized / EAC

Ex Approvals

Approval details

VDE Gutachten mit Fertigungsüberwachung		http://www.vde.com/en/Institute/OnlineService/ VDE-approved-products/Pages/Online-Search.aspx	40038423
Nominal current IN	8 A		
Nominal voltage UN	160 V		

IECEE CB Scheme		http://www.iecee.org/	DE1-56070_B1_B2
Nominal current IN	8 A		

Printed-circuit board connector - DMC 1,5/12-G1F-3,5-LR P20THR - 1787111

Approvals

Nominal voltage UN	160 V
--------------------	-------

cULus Recognized		http://database.ul.com/cgi-bin/XYV/template/LISEXT/1FRAME/index.htm	E60425-20110128
Nominal current IN	B	C	
Nominal current IN	8 A	8 A	
Nominal voltage UN	150 V	50 V	

EAC		B.01742
-----	--	---------

Accessories

Accessories

Coding element

Coding profile - CP-DMC 1,5 NAT - 1790647

Coding profile, for insertion between the coding ribs of the connector and the header following the reflow soldering process, insulating material, color: natural



Additional products

Printed-circuit board connector - DFMC 1,5/12-STF-3,5 - 1790399

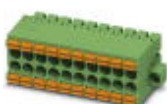

Plug, nominal current: 8 A, rated voltage (III/2): 160 V, number of positions: 12 with 24 contacts, pitch: 3.5 mm, connection method: spring-cage connection, color: green, contact surface: tin

Printed-circuit board connector - DFMC 1,5/12-ST-3,5-LR - 1790580



Plug, nominal current: 8 A, rated voltage (III/2): 160 V, number of positions: 12 with 24 contacts, pitch: 3.5 mm, connection method: spring-cage connection, color: green, contact surface: tin

