

Panel feed-through - SACC-DSI-FS-4CON-L180 SCO - 1553462

Please be informed that the data shown in this PDF Document is generated from our Online Catalog. Please find the complete data in the user's documentation. Our General Terms of Use for Downloads are valid (<http://phoenixcontact.com/download>)



Sensor/actuator flush-type socket, 4-pos., M12 SPEEDCON, A-coded, rear/screw mounting with Pg9 thread, with straight solder connection

Why buy this product

- Easy PCB assembly: one-piece connectors for wave soldering
- All standard pin assignments and codings for signal, data, and power transmission with a uniform design-in design
- SPEEDCON fast locking system reduces cabling times



Key Commercial Data

Packing unit	20 STK
Minimum order quantity	20 STK
GTIN	 4 046356 156875
GTIN	4046356156875
Weight per Piece (excluding packing)	13.100 g
Custom tariff number	85366990
Country of origin	Germany

Technical data

Dimensions

Length of the solder pin	6 mm
--------------------------	------

Ambient conditions

Ambient temperature (operation)	-25 °C ... 85 °C (Plug / socket)
	-40 °C ... 85 °C (without mechanical actuation)
Degree of protection	IP67

General

Note	The electrical and mechanical data specified assume that the connector pair is correctly locked and mounted. If the connector is unlocked and if there is a danger of contamination, the connector must be sealed using
------	---

Panel feed-through - SACC-DSI-FS-4CON-L180 SCO - 1553462

Technical data

General

	a protective cap > IP54. Influences arising from litz wires, cables or PCB assembly must also be taken into consideration.
Rated current at 40°C	4 A
Rated voltage	250 V
Rated surge voltage	2.5 kV
Number of positions	4
Insulation resistance	≥ 100 MΩ
Coding	A - standard
Standards/regulations	M12 connector IEC 61076-2-101
Status display	No
Overvoltage category	II
Degree of pollution	3
Connection method	Solder pins
Insertion/withdrawal cycles	> 100
Torque	3 Nm ... 4 Nm
Mounting type	Rear mounting Pg9 With flat nut

Material

Flammability rating according to UL 94	V0
Contact material	CuZn
Contact surface material	Au
Contact carrier material	PA 66
Material, knurls	Zinc die-cast, nickel-plated
Sealing material	NBR

Cable

Standards/specifications	M12 connector IEC 61076-2-101
Ambient temperature (operation)	-40 °C ... 85 °C (cable, fixed installation)
	-25 °C ... 85 °C (cable, flexible installation)

Standards and Regulations

Standard designation	M12 connector
Standards/regulations	IEC 61076-2-101
Flammability rating according to UL 94	V0

Environmental Product Compliance

China RoHS	Environmentally Friendly Use Period = 50
	For details about hazardous substances go to tab "Downloads", Category "Manufacturer's declaration"

Drawings

Panel feed-through - SACC-DSI-FS-4CON-L180 SCO - 1553462

Dimensional drawing

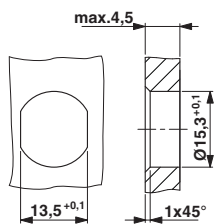

Schematic diagram

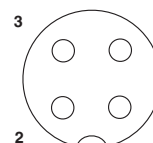

Pin assignment M12 socket, 4-pos., A-coded, view female side

Housing cutout for Pg9 fastening thread, mounting panel with feed-through hole (alternatively with area as anti-rotation protection for panel thicknesses > 2 mm up to max. 4.5 mm)

Drilling diagram

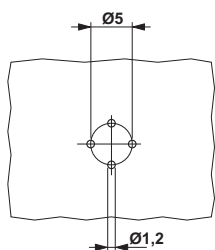

Dimensional drawing

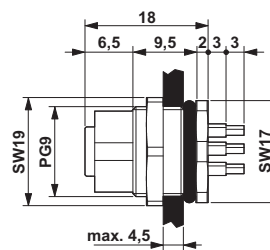

M12 flush-type connector

Dimensional drawing

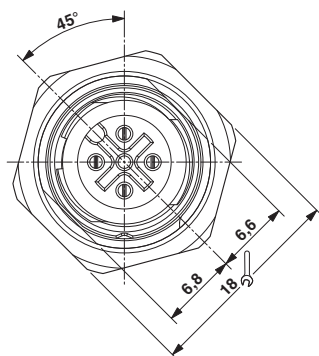

M12 front view

Classifications

eCl@ss

eCl@ss 4.0	27250313
eCl@ss 4.1	27250313
eCl@ss 5.0	27143423
eCl@ss 5.1	27143423
eCl@ss 6.0	27143423
eCl@ss 7.0	27449001

Panel feed-through - SACC-DSI-FS-4CON-L180 SCO - 1553462

Classifications

eCl@ss

eCl@ss 8.0	27440103
eCl@ss 9.0	27440102

ETIM

ETIM 3.0	EC002061
ETIM 4.0	EC002062
ETIM 5.0	EC002061
ETIM 6.0	EC002061

UNSPSC

UNSPSC 6.01	31251501
UNSPSC 7.0901	31251501
UNSPSC 11	31251501
UNSPSC 12.01	31251501
UNSPSC 13.2	39121413

Approvals

Approvals

Approvals

UL Recognized / cULus Recognized / EAC

Ex Approvals

Approval details

UL Recognized		http://database.ul.com/cgi-bin/XYV/template/LISEXT/1FRAME/index.htm	FILE E 118976
mm ² /AWG/kcmil	26-20		
Nominal current I _N	4 A		
Nominal voltage U _N	250 V		

cULus Recognized		http://database.ul.com/cgi-bin/XYV/template/LISEXT/1FRAME/index.htm	E221474-20140616
mm ² /AWG/kcmil	22-20		

Panel feed-through - SACC-DSI-FS-4CON-L180 SCO - 1553462

Approvals

Nominal current I _N	4 A
Nominal voltage U _N	250 V

EAC		B.01742
-----	--	---------

Accessories

Accessories

Protective cap

Screw plug - PROT-M12 - 1680539



An M12 screw plug for the unoccupied M12 sockets of the sensor/actuator cable, boxes and flush-type connectors

Screw plug - PROT-M12 SH - 1503302



An M12 screw plug for the unoccupied M12 sockets of the shielded sensor/actuator cable, boxes and flush-type connectors

Screw plug - PROT-M12 FB - 1555538



M12 high-grade steel screw plug, for unoccupied M12 sockets of the sensor/actuator cables, boxes and flush-type connectors for the food industry

Seal

Flat gasket - SACC-PG9-SEAL CLM - 1556320



Pg9 flat gasket for the rear mounting of M12 flush-type connectors with Pg9 fastening threads

