

Base strip - MSTBA 2,5/ 2-G-5,08 - 1757242

Please be informed that the data shown in this PDF Document is generated from our Online Catalog. Please find the complete data in the user's documentation. Our General Terms of Use for Downloads are valid (<http://phoenixcontact.com/download>)

Header, Nominal current: 12 A, Rated voltage (III/2): 320 V, Number of positions: 2, Pitch: 5.08 mm, Color: green, Contact surface: Tin, Mounting: Wave soldering



The figure shows a 10-position version of the product

Why buy this product

- Maximum flexibility when it comes to device design – one header for connectors with different connection technologies
- Well-known mounting principle allows worldwide use
- Plug-in direction parallel to the PCB
- Closed contour for optimum stability of the plug-in connection



Key Commercial Data

Packing unit	250 STK
Minimum order quantity	250 STK
GTIN	
GTIN	4017918029777
Weight per Piece (excluding packing)	0.920 g
Custom tariff number	85366990
Country of origin	Germany

Technical data

Dimensions

Length	12 mm
Pitch	5.08 mm
Dimension a	5.08 mm
Width	12.16 mm
Constructional height	8.6 mm
Height	12.1 mm
Length of the solder pin	3.5 mm

Base strip - MSTBA 2,5/ 2-G-5,08 - 1757242

Technical data

Dimensions

Pin dimensions	1 x 1 mm
Hole diameter	1.4 mm

General

Range of articles	MSTBA 2,5/..-G
Insulating material group	I
Rated surge voltage (III/3)	4 kV
Rated surge voltage (III/2)	4 kV
Rated surge voltage (II/2)	4 kV
Rated voltage (III/3)	250 V
Rated voltage (III/2)	320 V
Rated voltage (II/2)	400 V
Connection in acc. with standard	EN-VDE
Nominal current I_N	12 A
Maximum load current	12 A
Insulating material	PA
Flammability rating according to UL 94	V0
Color	green
Number of positions	2

Standards and Regulations

Connection in acc. with standard	EN-VDE
	CSA
Flammability rating according to UL 94	V0

Environmental Product Compliance

China RoHS	Environmentally friendly use period: unlimited = EFUP-e
	No hazardous substances above threshold values

Drawings

Drilling diagram

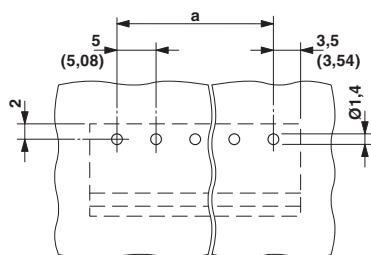

Diagram

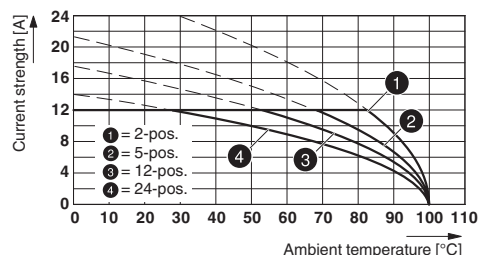

Type: ICV 2,5/..-G-5,08 with MSTBA 2,5/..-G-5,08

Base strip - MSTBA 2,5/ 2-G-5,08 - 1757242

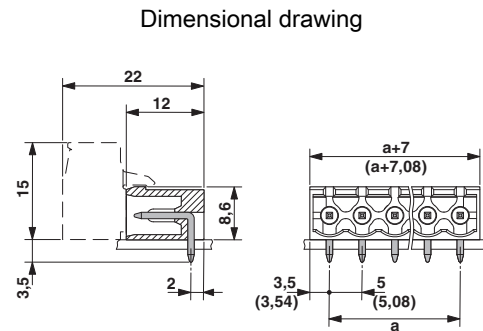
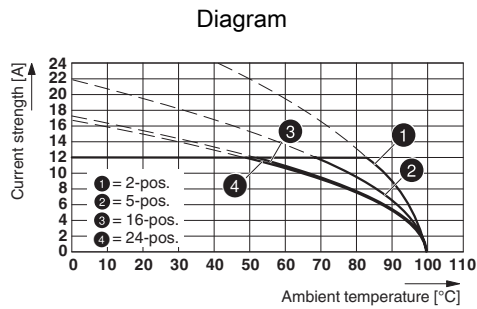

Type: IC 2,5/...-G-5,08 with MSTBA 2,5/...-G-5,08

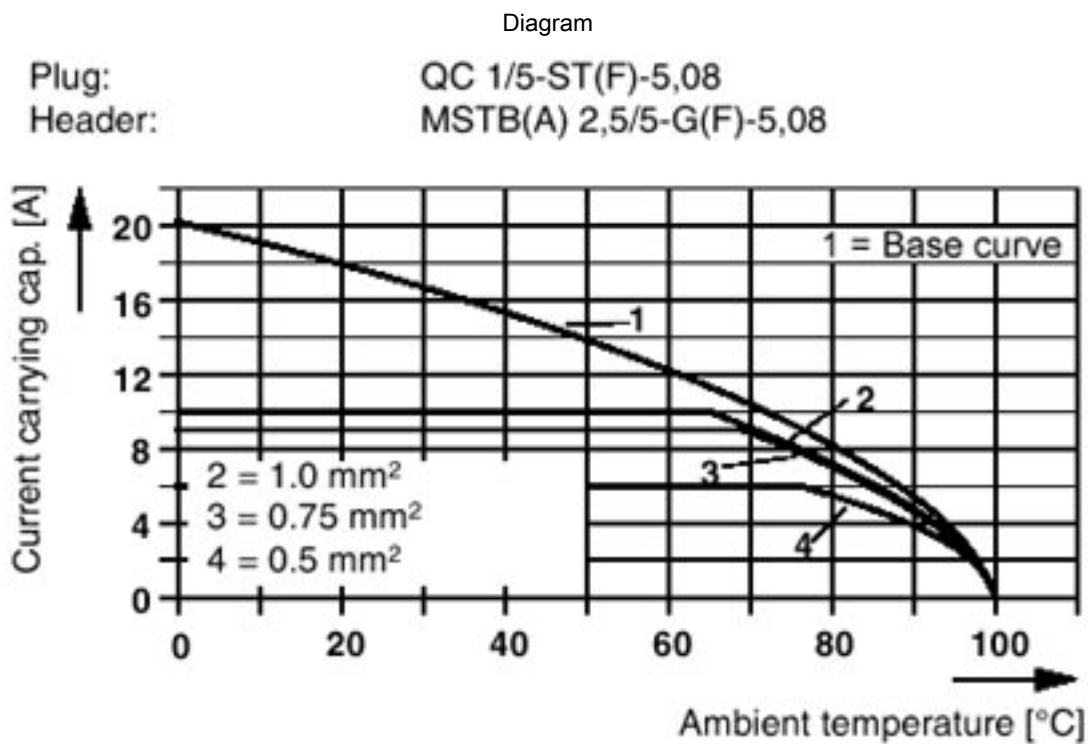

Base strip - MSTBA 2,5/ 2-G-5,08 - 1757242

Diagram

Plug: MSTBT 2,5/5-ST(F)-(-5,08)
Header: MSTB(A) 2,5/5-G(F)-(-5,08)

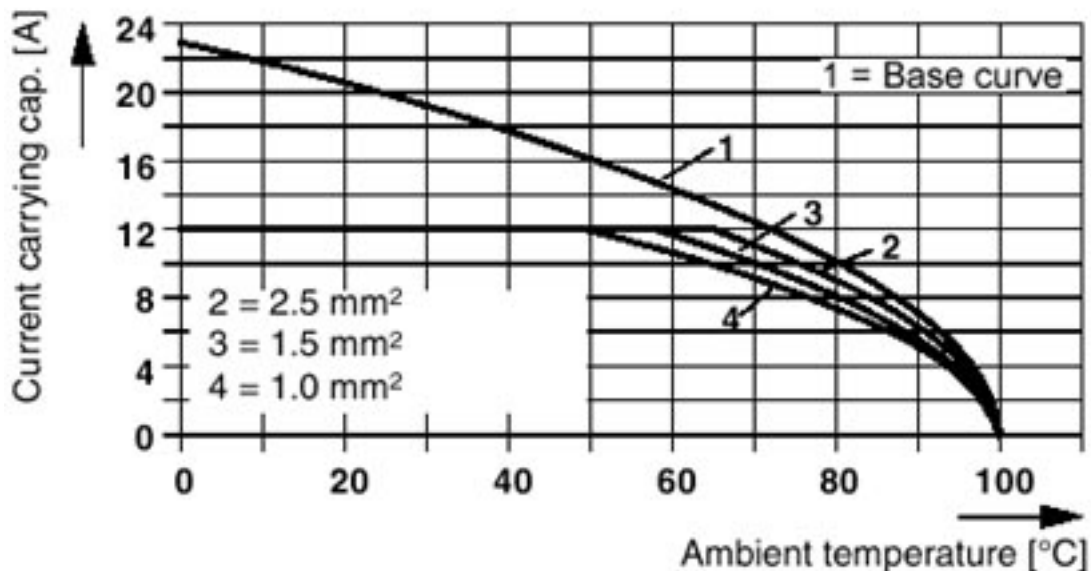

Diagram

Plug: SMSTB 2,5/5-ST(F)-(-5,08)
Header: MSTB(A) 2,5/5-G(F)-(-5,08)

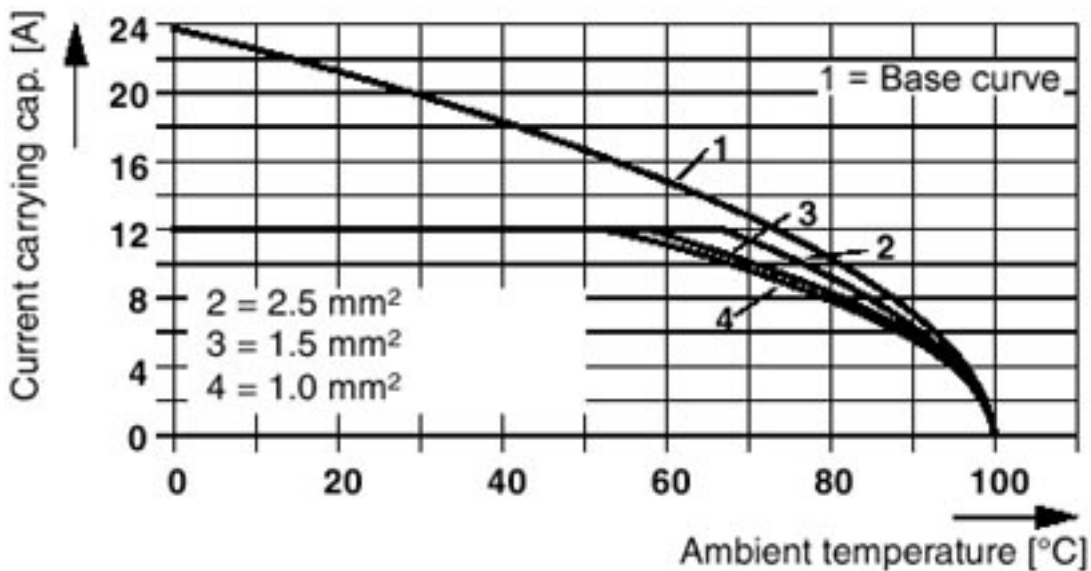

Base strip - MSTBA 2,5/ 2-G-5,08 - 1757242

Diagram

Plug: MVSTBR(W) 2,5/5-ST(F)-(-5,08)
Header: MSTB(A) 2,5/5-G(F)-(-5,08)

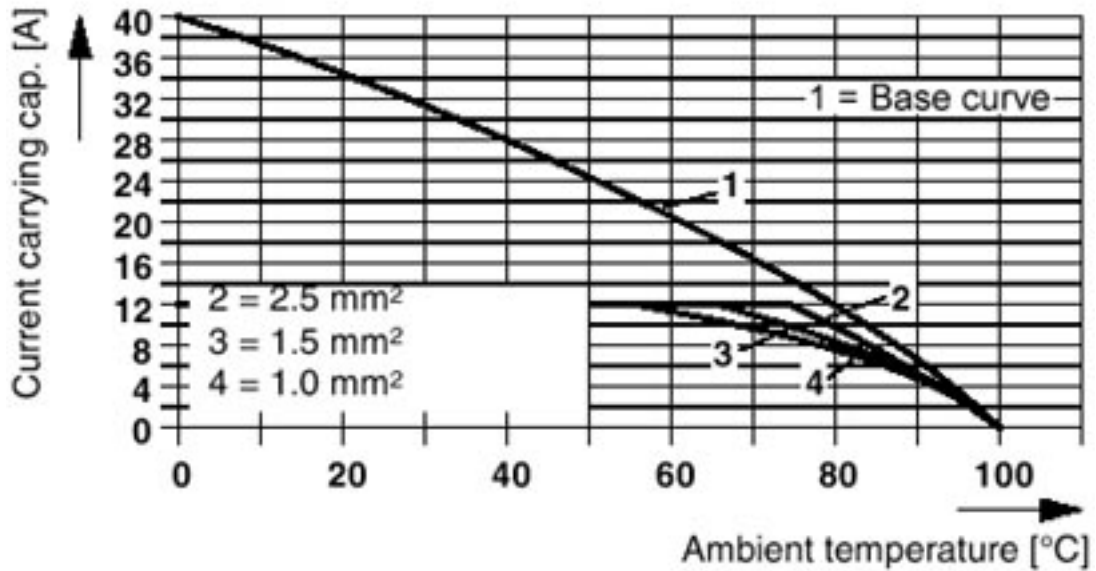

Diagram

Plug: FRONT-MSTB 2,5/5-ST(F)-(-5,08)
Header: MSTB(A) 2,5/5-G(F)-(-5,08)

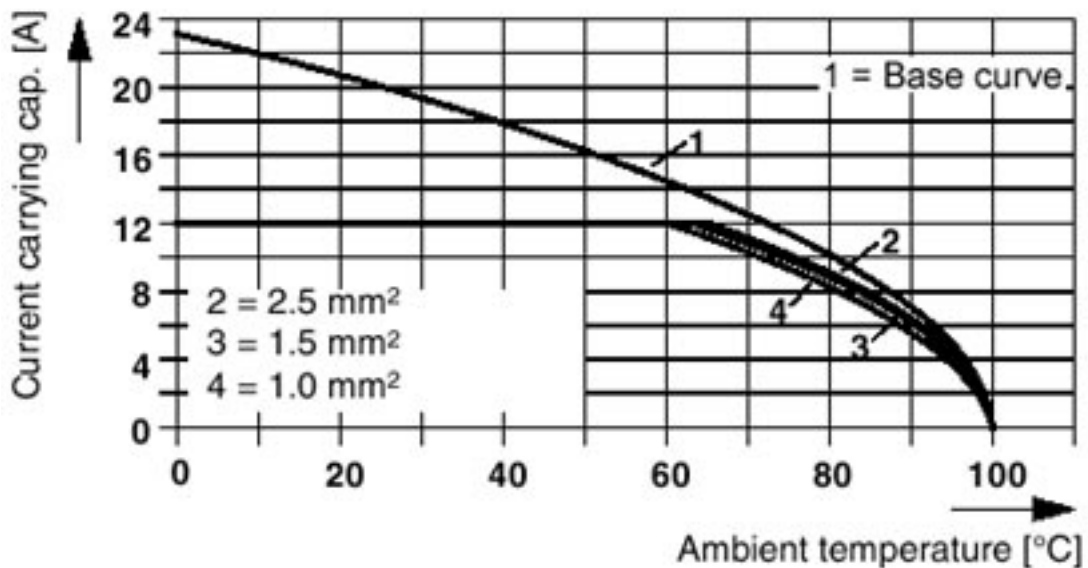

Base strip - MSTBA 2,5/ 2-G-5,08 - 1757242

Diagram

Plug: TMSTBP 2,5/5-ST(F)-(-5,08)
Header: MSTB(A) 2,5/5-G(F)-(-5,08)

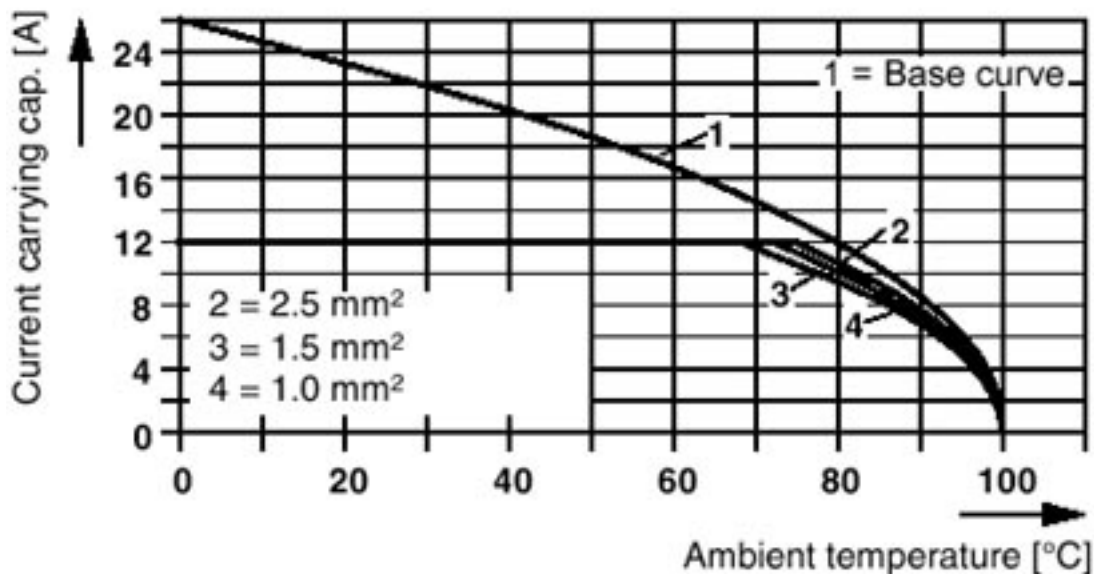

Diagram

Plug: FKC 2,5/5-ST(F)-5,08
Header: MSTB(A) 2,5/5-G(F)-5,08

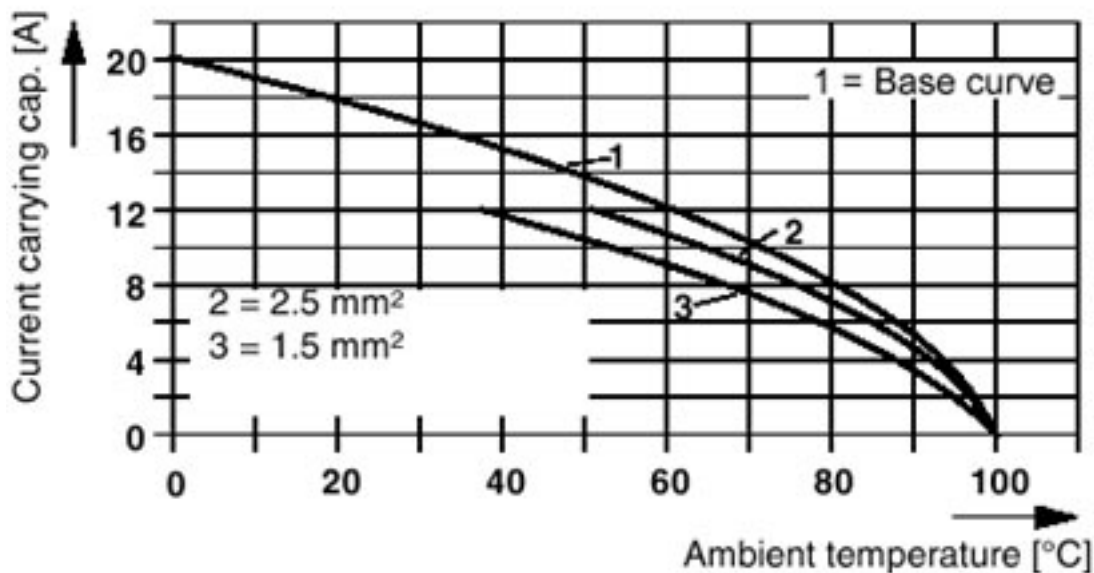

Base strip - MSTBA 2,5/ 2-G-5,08 - 1757242

Diagram

Plug: FKCVR(W) 2,5/5-ST(F)-5,08
 Header: MSTB(A) 2,5/5-G(F)-5,08

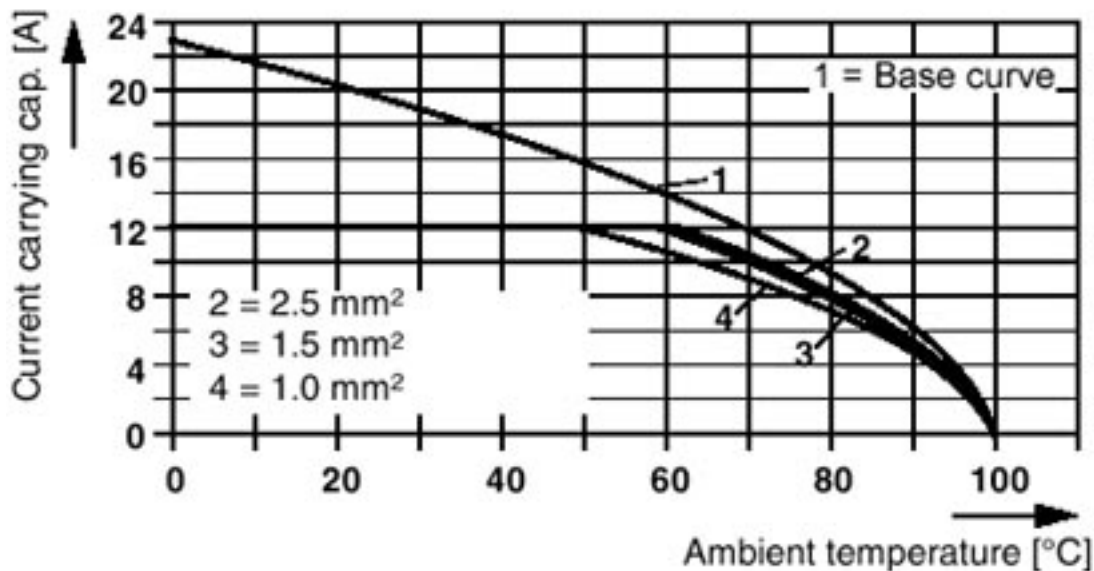

Diagram

Plug: MSTB 2,5/5-ST(F)(-5,08)
 Header: MSTBO 2,5/5-GR(L)(-5,08)

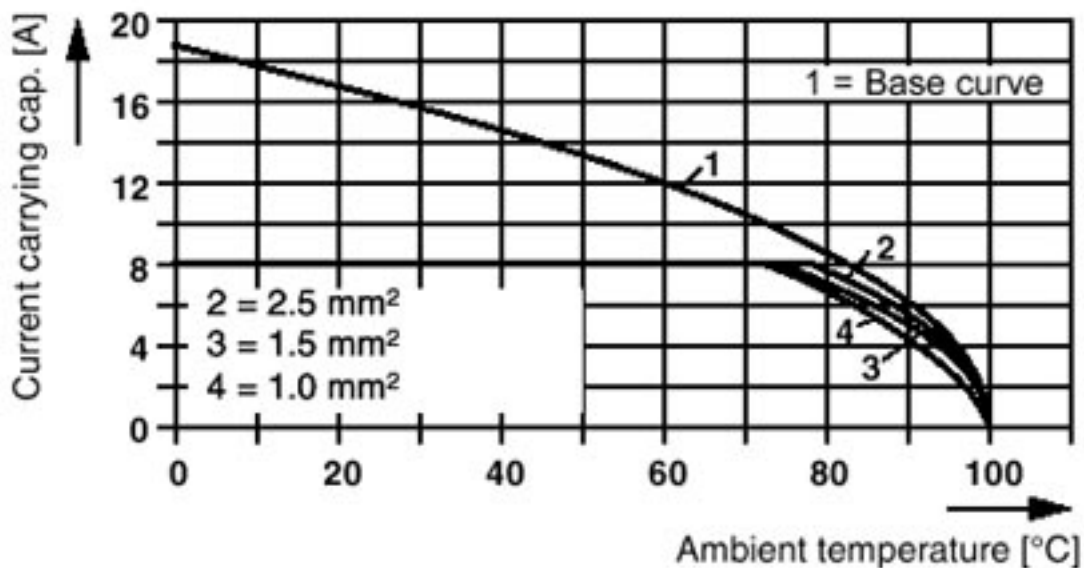

Base strip - MSTBA 2,5/ 2-G-5,08 - 1757242

Diagram

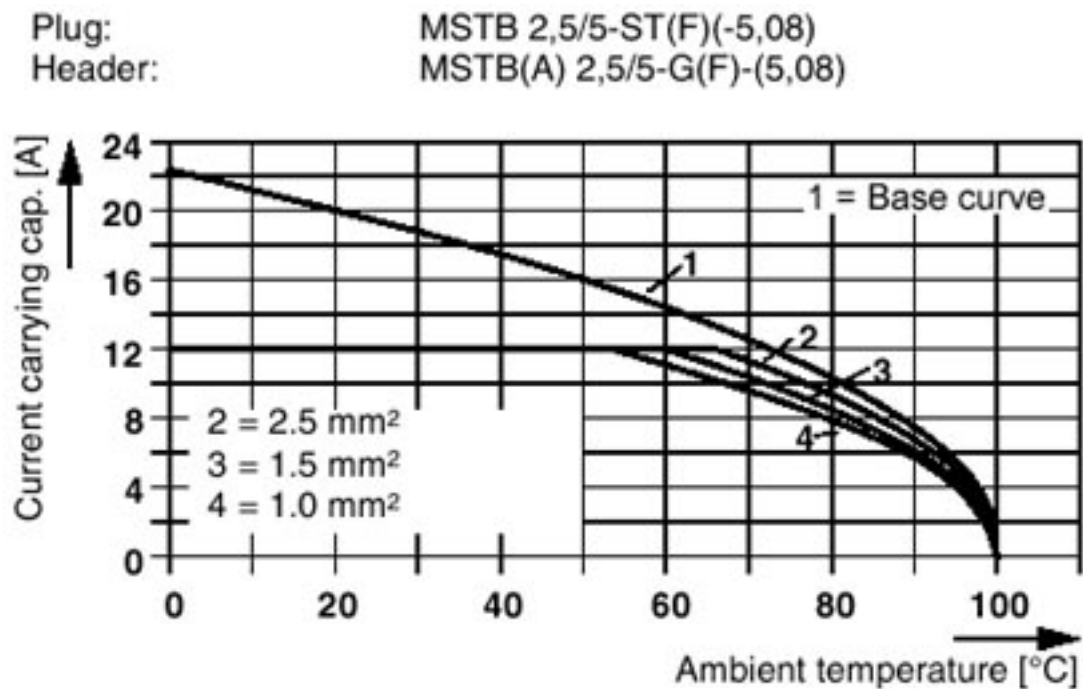

Classifications

eCl@ss

eCl@ss 4.0	272607xx
eCl@ss 4.1	27260701
eCl@ss 5.0	27260701
eCl@ss 5.1	27260701
eCl@ss 6.0	27260704
eCl@ss 7.0	27440402
eCl@ss 8.0	27440402
eCl@ss 9.0	27440402

ETIM

ETIM 3.0	EC001121
ETIM 4.0	EC002637
ETIM 5.0	EC002637
ETIM 6.0	EC002637

UNSPSC

UNSPSC 6.01	30211810
UNSPSC 7.0901	39121409
UNSPSC 11	39121409
UNSPSC 12.01	39121409
UNSPSC 13.2	39121409

Base strip - MSTBA 2,5/ 2-G-5,08 - 1757242

Approvals

Approvals

Approvals

CSA / VDE Gutachten mit Fertigungsüberwachung / IECEE CB Scheme / cULus Recognized / EAC

Ex Approvals

Approval details

CSA		http://www.csagroup.org/services/testing-and-certification/certified-product-listing/	13631
		B	D
Nominal current IN		15 A	10 A
Nominal voltage UN		300 V	300 V

VDE Gutachten mit Fertigungsüberwachung		http://www.vde.com/en/Institute/OnlineService/VDE-approved-products/Pages/Online-Search.aspx	40004701
Nominal current IN		12 A	
Nominal voltage UN		250 V	

IECEE CB Scheme		http://www.iecee.org/	DE1-56062-B1B2
Nominal current IN		12 A	
Nominal voltage UN		250 V	

cULus Recognized		http://database.ul.com/cgi-bin/XYV/template/LISEXT/1FRAME/index.htm	E60425-19931011
		B	D
Nominal current IN		15 A	10 A
Nominal voltage UN		300 V	300 V

EAC			B.01742
-----	--	--	---------

Base strip - MSTBA 2,5/ 2-G-5,08 - 1757242

Accessories

Accessories

Coding element

Coding star - CR-MSTB - 1734401



Coding section, inserted into the recess in the header or the inverted plug, red insulating material

Filler plug

Accessories - MSTB-BL - 1755477



Keying cap, for forming sections, plugs onto header pin, green insulating material

Labeled terminal marker

Marker card - SK 5,08/3,8:FORTL.ZAHLEN - 0804293



Marker card, Card, white, labeled, Horizontal: Consecutive numbers 1 - 10, 11 - 20, etc. up to 91 - (99)100, Mounting type: Adhesive, for terminal block width: 5.08 mm, Lettering field: 5.08 x 3.8 mm

Marker pen

Marker pen - B-STIFT - 1051993



Marker pen, for manual labeling of unprinted Zack strips, smear-proof and waterproof, line thickness 0.5 mm

Terminal marking

Base strip - MSTBA 2,5/ 2-G-5,08 - 1757242

Accessories

Marker card - SK 5,08/3,8:UNBEDRUCKT - 0805412



Marker card, Card, white, unlabeled, can be labeled with: Marker pen, Mounting type: Adhesive, for terminal block width: 5.08 mm, Lettering field: 5.08 x 3.8 mm

Additional products

Printed-circuit board connector - TVMSTB 2,5/ 2-ST-5,08 - 1719008



Plug component, Nominal current: 12 A, Rated voltage (III/2): 400 V, Number of positions: 2, Pitch: 5.08 mm, Connection method: Screw connection with tension sleeve, Color: green, Contact surface: Tin

Printed-circuit board connector - FKCN 2,5/ 2-ST-5,08 - 1754568



Plug component, Nominal current: 12 A, Rated voltage (III/2): 320 V, Number of positions: 2, Pitch: 5.08 mm, Connection method: Push-in spring connection, Color: green, Contact surface: Tin

Printed-circuit board connector - MSTB 2,5/ 2-ST-5,08 - 1757019



Plug component, Nominal current: 12 A, Rated voltage (III/2): 320 V, Number of positions: 2, Pitch: 5.08 mm, Connection method: Screw connection with tension sleeve, Color: green, Contact surface: Tin

Printed-circuit board connector - MSTBP 2,5/ 2-ST-5,08 - 1769010



Plug component, Nominal current: 12 A, Rated voltage (III/2): 320 V, Number of positions: 2, Pitch: 5.08 mm, Connection method: Screw connection with tension sleeve, Color: green, Contact surface: Tin

Base strip - MSTBA 2,5/ 2-G-5,08 - 1757242

Accessories

Printed-circuit board connector - FRONT-MSTB 2,5/ 2-ST-5,08 - 1777280

Plug component, Nominal current: 12 A, Rated voltage (III/2): 320 V, Number of positions: 2, Pitch: 5.08 mm, Connection method: Front screw connection, Color: green, Contact surface: Tin



Printed-circuit board connector - MSTBT 2,5/ 2-ST-5,08 - 1779987

Plug component, Nominal current: 12 A, Rated voltage (III/2): 320 V, Number of positions: 2, Pitch: 5.08 mm, Connection method: Screw connection with tension sleeve, Color: green, Contact surface: Tin



Printed-circuit board connector - MVSTBR 2,5/ 2-ST-5,08 - 1792249

Plug component, Nominal current: 12 A, Rated voltage (III/2): 320 V, Number of positions: 2, Pitch: 5.08 mm, Connection method: Screw connection with tension sleeve, Color: green, Contact surface: Tin



Printed-circuit board connector - MVSTBW 2,5/ 2-ST-5,08 - 1792757

Plug component, Nominal current: 12 A, Rated voltage (III/2): 320 V, Number of positions: 2, Pitch: 5.08 mm, Connection method: Screw connection with tension sleeve, Color: green, Contact surface: Tin



Printed-circuit board connector - MSTBC 2,5/ 2-ST-5,08 - 1808816

Plug component, Nominal current: 12 A, Rated voltage (III/2): 320 V, Number of positions: 2, Pitch: 5.08 mm, Connection method: Crimp connection, Color: green, Corresponding female crimp contacts with current [A] and conductor cross section range [mm²] data: 10A/MSTBC-MT 0,5-1,0 (3190564); 10A/MSTBC-MT 0,5-1,0 BA (3190645); 12A/MSTBC-MT 1,5-2,5 (3190551); 12A/MSTBC-MT 1,5-2,5 BA (3190658). BA = Bandkontakte



Base strip - MSTBA 2,5/ 2-G-5,08 - 1757242

Accessories

Printed-circuit board connector - MSTBC 2,5/ 2-STZ-5,08 - 1809501



Plug component, Nominal current: 12 A, Rated voltage (III/2): 320 V, Number of positions: 2, Pitch: 5.08 mm, Connection method: Crimp connection, Color: green, Corresponding female crimp contacts with current [A] and conductor cross section range [mm²] data: 10A/MSTBC-MT 0,5-1,0 (3190564); 10A/MSTBC-MT 0,5-1,0 BA (3190645); 12A/MSTBC-MT 1,5-2,5 (3190551); 12A/MSTBC-MT 1,5-2,5 BA (3190658). BA = Bandkontakte

Printed-circuit board connector - MSTBU 2,5/ 2-STD-5,08 - 1824120



Plug component, Nominal current: 12 A, Rated voltage (III/2): 320 V, Number of positions: 2, Pitch: 5.08 mm, Connection method: Screw connection with tension sleeve, Color: green, Contact surface: Tin, Mounting: Direct mounting

Printed-circuit board connector - MSTBU 2,5/ 2-ST-5,08-FL - 1824353



Plug component, Nominal current: 12 A, Rated voltage (III/2): 320 V, Number of positions: 2, Pitch: 5.08 mm, Connection method: Screw connection with tension sleeve, Color: green, Contact surface: Tin, Mounting: Direct mounting

Printed-circuit board connector - SMSTB 2,5/ 2-ST-5,08 - 1826283



Plug component, Nominal current: 12 A, Rated voltage (III/2): 320 V, Number of positions: 2, Pitch: 5.08 mm, Connection method: Screw connection with tension sleeve, Color: green, Contact surface: Tin

Printed-circuit board connector - TMSTBP 2,5/ 2-ST-5,08 - 1853010



Plug component, Nominal current: 12 A, Rated voltage (III/2): 320 V, Number of positions: 2, Pitch: 5.08 mm, Connection method: Screw connection with tension sleeve, Color: green, Contact surface: Tin, The plug allows conductors to be looped through from module to module.

Base strip - MSTBA 2,5/ 2-G-5,08 - 1757242

Accessories

Printed-circuit board connector - FKC 2,5/ 2-ST-5,08 - 1873058

Plug component, Nominal current: 12 A, Rated voltage (III/2): 320 V, Number of positions: 2, Pitch: 5.08 mm, Connection method: Push-in spring connection, Color: green, Contact surface: Tin



Printed-circuit board connector - FKCVW 2,5/ 2-ST-5,08 - 1873650

Plug component, Nominal current: 12 A, Rated voltage (III/2): 320 V, Number of positions: 2, Pitch: 5.08 mm, Connection method: Push-in spring connection, Color: green, Contact surface: Tin



Printed-circuit board connector - FKCVR 2,5/ 2-ST-5,08 - 1873951

Plug component, Nominal current: 12 A, Rated voltage (III/2): 320 V, Number of positions: 2, Pitch: 5.08 mm, Connection method: Push-in spring connection, Color: green, Contact surface: Tin



Printed-circuit board connector - QC 1/ 2-ST-5,08 - 1883255

Plug component, Nominal current: 10 A, Rated voltage (III/2): 630 V, Number of positions: 2, Pitch: 5.08 mm, Connection method: Displacement connection, Color: green, Contact surface: Tin

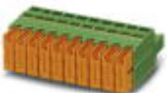

Printed-circuit board connector - FKCT 2,5/ 2-ST-5,08 - 1902110

Plug component, Nominal current: 12 A, Rated voltage (III/2): 320 V, Number of positions: 2, Pitch: 5.08 mm, Connection method: Push-in spring connection, Color: green, Contact surface: Tin



Base strip - MSTBA 2,5/ 2-G-5,08 - 1757242

Accessories

Printed-circuit board connector - TFKC 2,5/ 2-ST-5,08 - 1962600

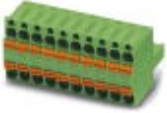

Plug component, Nominal current: 12 A, Rated voltage (III/2): 320 V, Number of positions: 2, Pitch: 5.08 mm, Connection method: Push-in spring connection, Color: green, Contact surface: Tin

Printed-circuit board connector - FKCS 2,5/ 2-ST-5,08 - 1975079



Plug component, Nominal current: 12 A, Rated voltage (III/2): 320 V, Number of positions: 2, Pitch: 5.08 mm, Connection method: Push-in spring connection, Color: green, Contact surface: Tin