

**Push-Pull Connectors  
Cable Mounted Plug**

CCA Series

**Part Number: CCA2P1/A06  
Pole: 6**

Illustration

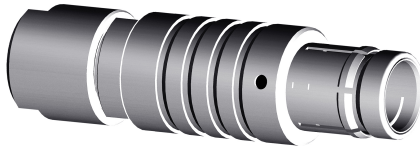

Size Drawing

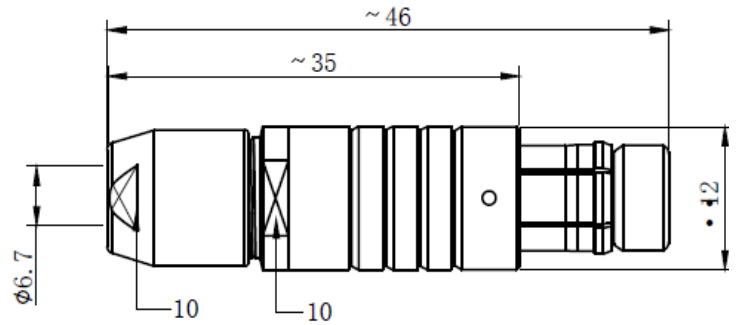

Insert Configuration

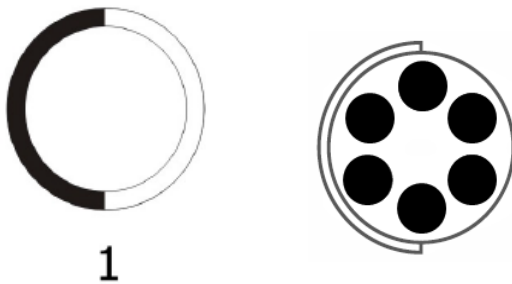

**Technical Data**

Common Values

Shell Style/Model:	Cable mounted straight plug, male contact
Codes:	Code 1
Contact Type:	Solder type
Contact Diameter:	0.7mm

Material

Housing Material:	Brass (natural chrome plated) shell and collet nut, nickel plated brass latch sleeve and mid pieces
Insulator:	PPS
Contacts:	Brass (Gold plated)

Electrical Values

Max. Stranded Conductor	AWG21-22
Max Diameter:	0.79mm
Vtest (contact-shell):	1000V(AC) 2000V(DC)
Vtest (contact-contact):	1300V(AC) 2000V(DC)
Rated Current:	5.2A
Rated Voltage:	≤ 250V
Mechanical Operation:	5000 mating cycles

Others

Humidity (max):	≤95% [at 60 deg C /140 F]
Vibration:	15 g [10 Hz - 2000 Hz]
Shock Resistance:	100 g [ 6 ms]
Salt Spray Corrosion:	>72 hr
Climatical Category:	50/175/21
Shielding (min):	75 dB (10 MHz)
Shielding (min):	40 dB (1 GHz)
IP Rating:	68