

Sensor/actuator connector - SACC-FS-4QO-0,34-M SCO - 1521588

Please be informed that the data shown in this PDF Document is generated from our Online Catalog. Please find the complete data in the user's documentation. Our General Terms of Use for Downloads are valid (<http://phoenixcontact.com/download>)



Sensor/actuator connector, 4-position, Socket straight M12 SPEEDCON, A-coded, Insulation displacement connection, Knurl material: Zinc die-cast, nickel-plated, External cable diameter 3.5 mm ... 6 mm

Why buy this product

- Safe use in the field, thanks to a high degree of protection
- Flexible: connectors for on-site assembly
- Save time, thanks to installation with SPEEDCON fast locking system
- Insulation displacement connection: innovative and time-saving assembly without stripping the single wire



Key Commercial Data

| | |
|--------------------------------------|---|
| Packing unit | 1 STK |
| GTIN |  4 017918 953058 |
| GTIN | 4017918953058 |
| Weight per Piece (excluding packing) | 12.160 g |
| Custom tariff number | 85366990 |
| Country of origin | Germany |

Technical data

Dimensions

| | |
|--------------------------------|-----------------|
| Wrench size, union nut | 13 mm |
| External cable diameter | 3.5 mm ... 6 mm |
| Stripping length of the sheath | 40 mm |

Ambient conditions

| | |
|---------------------------------|-----------------------------------|
| Ambient temperature (operation) | -25 °C ... 80 °C (Plug / socket) |
| Ambient temperature (assembly) | -5 °C ... 50 °C (During assembly) |
| Degree of protection | IP65 |
| | IP67 |

Sensor/actuator connector - SACC-FS-4QO-0,34-M SCO - 1521588

Technical data

General

| | |
|---|---|
| Rated current at 40°C | 4 A |
| Rated voltage | 125 V |
| Number of positions | 4 |
| Insulation resistance | ≥ 100 MΩ |
| Coding | A - standard |
| Standards/regulations | M12 connector IEC 61076-2-101 |
| Status display | No |
| Overvoltage category | II |
| Degree of pollution | 3 |
| Connection method | Insulation displacement connection |
| Conductor cross section | 0.14 mm² ... 0.34 mm² |
| Conductor cross section AWG | 26 ... 22 |
| Wire diameter including insulation | 0.7 mm ... 1.6 mm |
| Frequency of connections between conductors of the same cross section | 10 |
| Wire insulation material | PVC / PE / PP / rubber |
| Structure of individual litz in acc. with VDE 0295 / smallest wire diameter | Class 2-6 |
| Insertion/withdrawal cycles | ≥ 100 |
| Torque | 0.4 Nm (M12 knurl) 1.2 Nm (Pressure nut) |
| Assembly instructions | AWG 20 conductor cross section upon request |

Material

| | |
|--|------------------------------|
| Flammability rating according to UL 94 | V0 |
| Contact material | CuSn |
| Contact surface material | Ni/Au |
| Contact carrier material | TPU |
| Material of grip body | PA 6 |
| Material, knurls | Zinc die-cast, nickel-plated |
| Sealing material | NBR |

Cable

| | |
|--------------------------|-------------------------------|
| Standards/specifications | M12 connector IEC 61076-2-101 |
|--------------------------|-------------------------------|

Standards and Regulations

| | |
|--|-----------------|
| Standard designation | M12 connector |
| Standards/regulations | IEC 61076-2-101 |
| Connection in acc. with standard | CUL |
| Flammability rating according to UL 94 | V0 |

Environmental Product Compliance

| | |
|------------|---|
| China RoHS | Environmentally friendly use period: unlimited = EFUP-e |
|------------|---|

Sensor/actuator connector - SACC-FS-4QO-0,34-M SCO - 1521588

Technical data

Environmental Product Compliance

| | |
|--|--|
| | No hazardous substances above threshold values |
|--|--|

Drawings

Schematic diagram

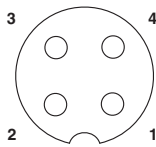

Pin assignment M12 socket, 4-pos., A-coded, view female side

Functional drawing

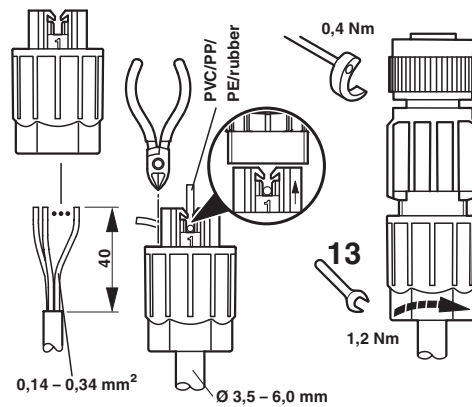

Dimensional drawing

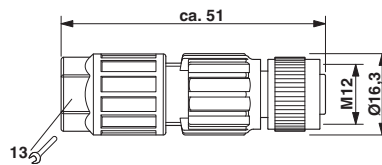

M12 x 1 socket, straight

Classifications

eCl@ss

| | |
|------------|----------|
| eCl@ss 4.0 | 27140815 |
| eCl@ss 4.1 | 27140815 |
| eCl@ss 5.0 | 27143423 |
| eCl@ss 5.1 | 27143423 |
| eCl@ss 6.0 | 27143423 |
| eCl@ss 7.0 | 27449001 |
| eCl@ss 8.0 | 27440104 |
| eCl@ss 9.0 | 27440102 |

ETIM

| | |
|----------|----------|
| ETIM 2.0 | EC000516 |
|----------|----------|

Sensor/actuator connector - SACC-FS-4QO-0,34-M SCO - 1521588

Classifications

ETIM

| | |
|----------|----------|
| ETIM 3.0 | EC000516 |
| ETIM 4.0 | EC002062 |
| ETIM 5.0 | EC002062 |
| ETIM 6.0 | EC002062 |

UNSPSC

| | |
|---------------|----------|
| UNSPSC 6.01 | 31261501 |
| UNSPSC 7.0901 | 31261501 |
| UNSPSC 11 | 31261501 |
| UNSPSC 12.01 | 31261501 |
| UNSPSC 13.2 | 39121413 |

Approvals

Approvals

Approvals

UL Recognized / cUL Recognized / EAC / EAC / cULus Recognized

Ex Approvals

Approval details

| | | | |
|--------------------|---|---|---------------|
| UL Recognized |  | http://database.ul.com/cgi-bin/XYV/template/LISEXT/1FRAME/index.htm | FILE E 118976 |
| | | | |
| Nominal current IN | 4 A | | |
| Nominal voltage UN | 300 V | | |

| | | | |
|--------------------|---|---|---------------|
| cUL Recognized |  | http://database.ul.com/cgi-bin/XYV/template/LISEXT/1FRAME/index.htm | FILE E 118976 |
| | | | |
| Nominal current IN | 4 A | | |
| Nominal voltage UN | 300 V | | |

| | | |
|-----|---|---------------|
| EAC |  | EAC-Zulassung |
|-----|---|---------------|

Sensor/actuator connector - SACC-FS-4QO-0,34-M SCO - 1521588

Approvals

| | | |
|-----|--|---------------------|
| EAC | | 7500651.22.01.00246 |
|-----|--|---------------------|

| | | |
|------------------|--|---|
| cULus Recognized | | http://database.ul.com/cgi-bin/XYV/template/LISEXT/1FRAME/index.htm |
|------------------|--|---|

Accessories

Accessories

Cable by the meter

Cable reel - SAC-4P-100,0-PUR/0,25 - 1501692



Cable ring, PUR halogen-free black, 4-pos., conductor colors: brown / white / blue / black, cable length: 100 m

Cable reel - SAC-4P-100,0-PUR/0,34 - 1501663



Cable ring, PUR halogen-free black, 4-pos., conductor colors: brown / white / blue / black, cable length: 100 m

Protective cap

Screw plug - PROT-M12 MS-PA-CHAIN - 1430899

M12 sealing cap with fixing band, for sensor cables, for free M12 sockets



Screwdriver tools

Sensor/actuator connector - SACC-FS-4QO-0,34-M SCO - 1521588

Accessories

Tool - SAC BIT M12-D15 - 1208432



Nut for assembling sensor/actuator cables with M12 connector and M12 connectors for assembly, with a knurl diameter of 15 mm, for 4 mm hexagonal drive

Adapter insert - TSD-M SAC-BIT ADAPTER - 1212600



Adapter bit for TSD-M...torque tools, E6.3-1/4" drive with 4 mm hexagon to accommodate SAC bits

Tool - SAC BIT QUICKON-W13 - 1212033



Nut for assembling pressure nuts with 13 mm wrench size, for 4 mm hexagonal drive

Torque tool

Torque screwdriver - TSD 04 SAC - 1208429



Torque screwdriver, with preset torque of 0.4 Nm and 4 mm hexagonal drive for M12 connectors

Torque screwdriver - TSD-M 1,2NM - 1212224



Torque screw driver, accuracy as per EN ISO 6789 standard, adjustable from 0.3 - 1.2 Nm