

Three-phase monitoring relay CM-PFS

The CM-PFS is a three-phase monitoring relay that is used to monitor three phase mains for incorrect phase sequence and phase failure.

All devices are available with two different terminal versions. You can choose between the proven screw connection technology (double-chamber cage connection terminals) and the completely tool-free Easy Connect Technology (Push-in terminals).

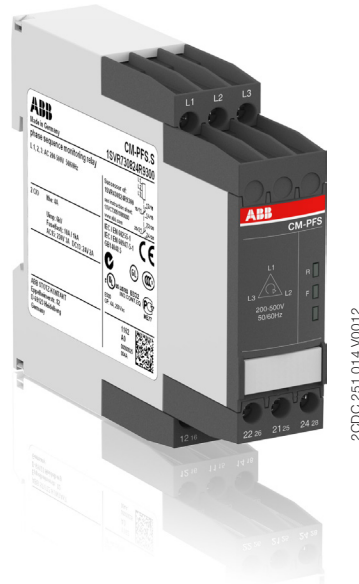

Characteristics

- Monitoring of three-phase mains for phase sequence and failure
- Suitable for railway applications
- Powered by the measuring circuit
- Closed-circuit principle
- Screw connection technology or Easy Connect Technology available
- Housing material for highest fire protection classification UL 94 V-0
- Tool-free mounting on DIN rail as well as demounting
- 2 c/o (SPDT) contacts
- 22.5 mm (0.89 in) width
- 2 LEDs for the indication of operational states

Order data

Three-phase monitoring relay

Type	Rated control supply voltage = measuring voltage	Connection technology	Order code
CM-PFS.P	3 x 200-500 V AC	Push-in terminals	1SVR740824R9300
CM-PFS.S	3 x 200-500 V AC	Screw type terminals	1SVR730824R9300

Accessories

Type	Description	Order code
ADP.01	Adapter for screw mounting	1SVR430029R0100
MAR.01	Marker label	1SVR366017R0100
COV.11	Sealable transparent cover	1SVR730005R0100

Connection technology

Maintenance free Easy Connect Technology with push-in terminals

Type designation CM-xxS.yyP

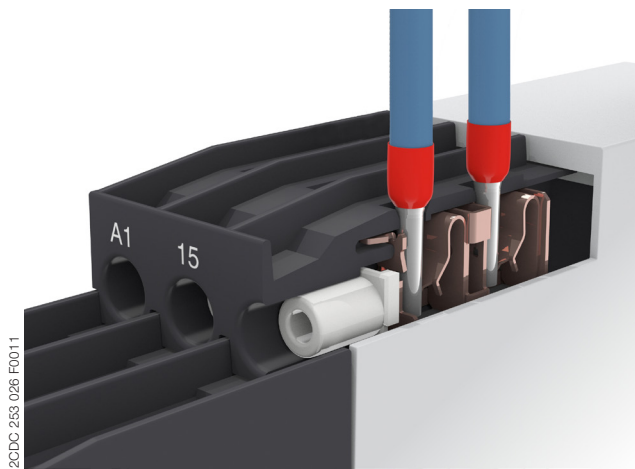

Push-in terminals

- Tool-free connection of rigid and flexible wires with wire end ferrule
- Easy connection of flexible wires without wire end ferrule by opening the terminals
- No retightening necessary
- One operation lever for opening both connection terminals
- For triggering the lever and disconnecting of wires you can use the same tool (Screwdriver according to DIN ISO 2380-1 Form A 0.8 x 4 mm (0.0315 x 0.157 in), DIN ISO 8764-1 PZ1 \varnothing 4.5 mm (0.177 in))
- Constant spring force on terminal point independent of the applied wire type, wire size or ambient conditions (e. g. vibrations or temperature changes)
- Opening for testing the electrical contacting
- Gas-tight

Approved screw connection technology with double-chamber cage connection terminals

Type designation CM-xxS.yyS

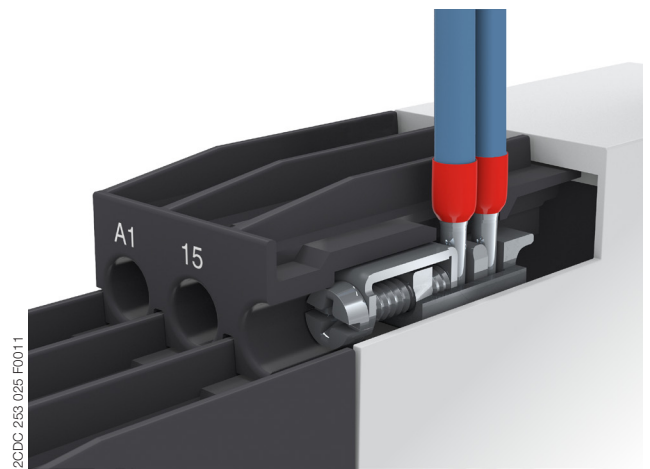

Double-chamber cage connection terminals

- Terminal spaces for different wire sizes: fine-strand with/without wire end ferrule
- One screw for opening and closing of both cages
- Pozidrive screws for pan- or crosshead screwdrivers according to DIN ISO 2380-1 Form A 0.8 x 4 mm (0.0315 x 0.157 in), DIN ISO 8764-1 PZ1 \varnothing 4.5 mm (0.177 in)

Both the Easy Connect Technology with push-in terminals and screw connection technology with double-chamber cage connection terminals have the same connection geometry as well as terminal position.

Functions

Operating controls

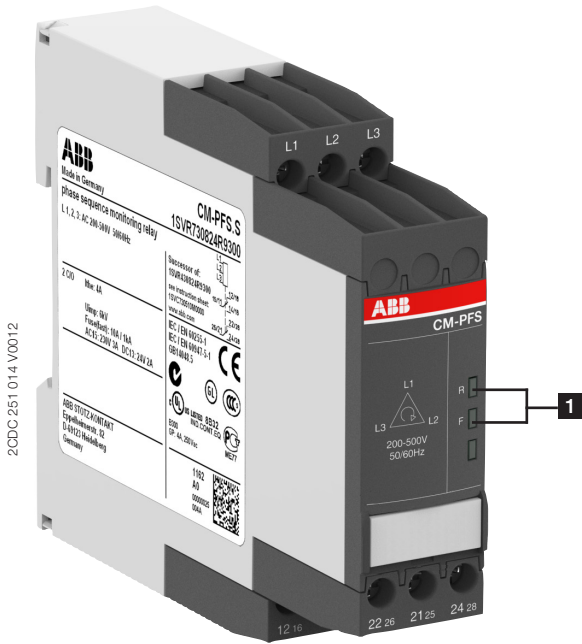

1 Indication of operational states

R: yellow LED – status indication of the output relays

F: red LED – fault message

Application

The CM-PFS is used to monitor three-phase mains for incorrect phase sequence and phase failure.

Operating mode

The three-phase main to be monitored is connected to terminals L1, L2, L3 in accordance to the wiring diagram.

The device operates according to the closed-circuit principle  – incorrect phase sequence or phase failure: relays de-energize.

The signalling of status indication is made by means of the front-face LEDs.

Function diagram

Phase sequence and phase failure monitoring

If all phases are present with the correct phase sequence, the output relays energize after the start-up delay t_s is complete.

If a phase failure or a phase sequence error occurs, the output relays de-energize instantaneously.

The LED R is on when output relays are energized.

In case of motors which continue running with only two phases, the CM-PFS detects phase failure if the reverse fed voltage is less than 60% of the originally applied voltage.

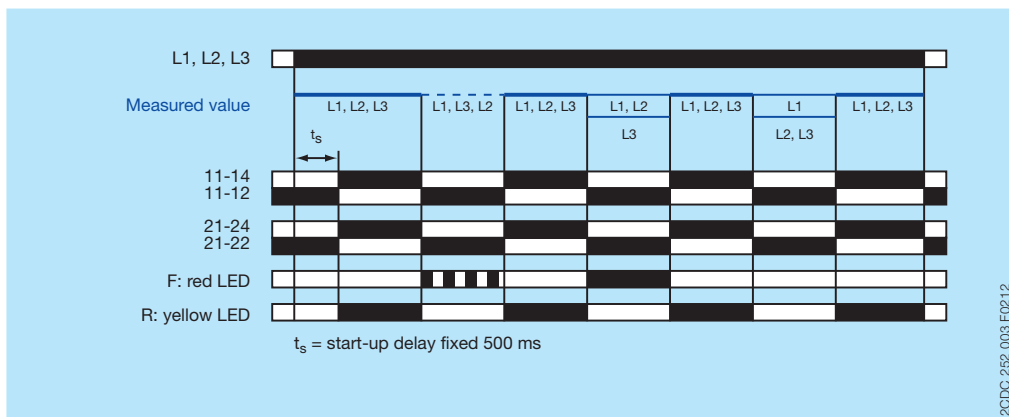

Electrical connection

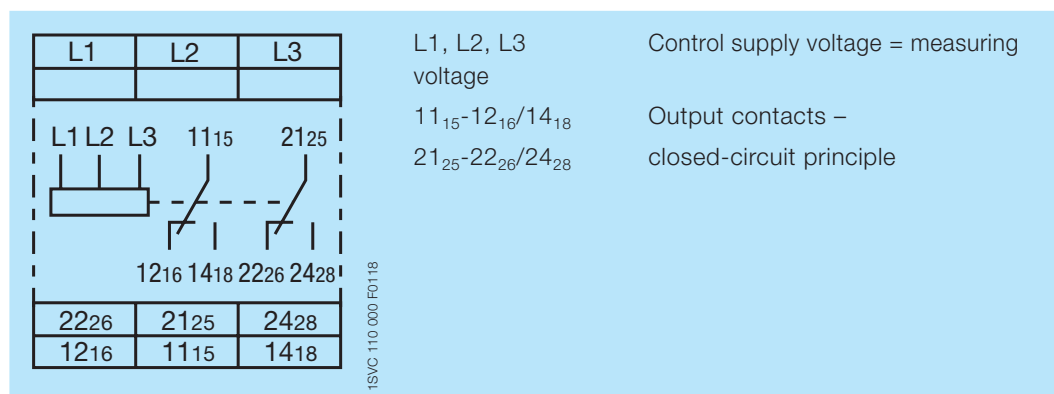

Connection diagram

Technical data

Data at $T_a = 25\text{ °C}$ and rated values, unless otherwise indicated

Input circuits

Supply circuit = measuring circuit	L1, L2, L3
Rated control supply voltage $U_s =$ measuring voltage	3 x 200-500 V AC
Rated control supply voltage U_s tolerance	-15...+10 %
Rated frequency	50/60 Hz
Frequency range	45-65 Hz
Typical current / power consumption	400 V AC 16 mA / 11 VA

Measuring circuit	L1, L2, L3
Monitoring functions	phase failure phase sequence
Measuring range	3 x 200-500 V AC
Threshold value for phase failure	U_{min} 0.6 x U_n
Hysteresis related to the threshold value	-
Rated frequency of the measuring signal	50/60 Hz
Frequency range of the measuring signal	45-65 Hz
Response time	500 ms
Measuring principle	True RMS

Timing circuit	
Start-up delay t_s	fixed 500 ms

User interface

Indication of operational states		
Relay status R1, R2	R: yellow LED	Output relay energized
Fault message	F: red LED	Phase failure
		Phase sequence error

Output circuits

Kind of output	11(15)-12(16)/14(18)	relay, 1st c/o (SPDT) contact
	21(25)-22(26)/24(28)	relay, 2nd c/o (SPDT) contact
		1 x 2 c/o (SPDT) contacts
Operating principle		closed-circuit principle ¹⁾
Contact material		AgNi alloy, Cd free
Rated operational voltage U _o		250 V AC
Minimum switching voltage / Minimum switching current		24 V / 10 mA
Maximum switching voltage / Maximum switching current		„Load limit curves“ on page 7
Rated operational current I _o	AC-12 (resistive) at 230 V	4 A
	AC-15 (inductive) at 230 V	3 A
	DC-12 (resistive) at 24 V	4 A
	DC-13 (inductive) at 24 V	2 A
AC rating (UL 508)	utilization category	B 300, pilot duty
	(Control Circuit Rating Code)	general purpose (250 V, 4 A, cos phi 0.75)
	max. rated operational voltage	300 V AC
	max. continuous thermal current at B 300	5 A
	max. making/breaking apparent power at B 300	3600/360 VA
Mechanical lifetime		30 x 10 ⁶ switching cycles
Electrical lifetime	AC-12, 230 V, 4 A	0.1 x 10 ⁶ switching cycles
Maximum fuse rating to achieve	n/c contact	6 A fast-acting
short-circuit protection	n/o contact	10 A fast-acting
Conventional thermal current I _{th}		4 A

¹⁾ Closed-circuit principle: output relays de-energize if the measured value exceeds/drops below the threshold.

General data

MTBF		on request
Duty time		100 %
Dimensions		see „Dimensional drawings“
Weight		Screw connection technology
		Easy Connect Technology (push-in)
	net weight	0.128 kg (0.282 lb)
	gross weight	0.156 kg (0.344 lb)
Mounting		DIN rail (IEC/EN 60715), snap-on mounting without any tool
Mounting position		any
Minimum distance to other units	vertical/ horizontal	≥ 10 mm (0.39 in) in case of continuous measuring voltage > 440 V
Degree of protection	housing / terminal	IP50 / IP20

Electrical connection

		Screw connection technology	Easy Connect Technology (push-in)
Connecting capacity	fine-strand with(out) wire end ferrule	1 x 0.5-2.5 mm ² (1 x 18-14 AWG)	2 x 0.5-1.5 mm ² (2 x 18-16 AWG)
		2 x 0.5-1.5 mm ² (2 x 18-16 AWG)	
	rigid	1 x 0.5-4 mm ² (1 x 20-12 AWG)	2 x 0.5-1.5 mm ² (2 x 20-16 AWG)
		2 x 0.5-2.5 mm ² (2 x 20-14 AWG)	
Stripping length		8 mm (0.32 in)	
Tightening torque		0.6 - 0.8 Nm (7.08 lb.in)	-

Environmental data

Ambient temperature ranges	operation	-25...+60 °C
	storage	-40...+85 °C
	transport	-40...+85 °C
Climatic class	IEC/EN 60721-3-3	3K3
Damp heat, cyclic	IEC/EN 60068-2-30	6 x 24 cycle, 55 °C, 95 % RH
Vibration, sinusoidal		Class 2
Shock		Class 2

Isolation data

Rated insulation voltage U_i	input circuit / output circuit	600 V
	output circuit 1 / output circuit 2	300 V
Rated impulse withstand voltage U_{imp}	input circuit / output circuit	6 kV
	output circuit 1 / output circuit 2	4 kV
Basic insulation	input circuit / output circuit	600 V AC
Protective separation (IEC/EN 61140, EN 50178)	input circuit / output circuit	n/a
Pollution degree		3
Overvoltage category		III

Standards / Directives

Standards	IEC/EN 60947-5-1, IEC/EN 60255-27, EN 50178
Low Voltage Directive	2014/35/EU
EMC directive	2014/30/EU
RoHS directive	2011/65/EU

Railway application standards

EN 50155, IEC 60571	temperature class	T3
"Railway applications – Electronic equipment used on rolling stock"	supply voltage category	S1, S2, C1*), C2*)
IEC/EN 61373		Category 1, Class B
"Railway applications – Rolling stock equipment – Shock and vibration tests"		
EN 45545-2 Railway applications – Fire protection on railway vehicles – part 2: Requirements for fire behavior of materials and components		HL3
	ISO 4589-2	LOI 32.3 %
	NF X-70-100-1	C.I.T. (T12) 0.45
	EN ISO 5659-2	Ds max (T10.03) 104
NF F 16-101: Rolling stock. Fire behaviour. Materials choosing		I2 / F2
NF F 16-102: Railway rolling stock. Fire behaviour. Materials choosing, application for electric equipment		
DIN 5510-2 Preventive fire protection in railway vehicles. Part 2: Fire behaviour and fire side effects of materials and parts		fulfilled

*) only applicable for devices with DC supply

Electromagnetic compatibility

Interference immunity to		IEC/EN 61000-6-2
electrostatic discharge	IEC/EN 61000-4-2	Level 3, 6 kV / 8 kV
radiated, radio-frequency, electromagnetic field	IEC/EN 61000-4-3	Level 3, 10 V/m (1 GHz) / 3 V/m (2 GHz) / 1 V/m (2.7 GHz)
electrical fast transient/burst	IEC/EN 61000-4-4	Level 3, 2 kV / 5 kHz
surge	IEC/EN 61000-4-5	Level 3, 2 kV L-L
conducted disturbances, induced by radio-frequency fields	IEC/EN 61000-4-6	Level 3, 10 V
voltage dips, short interruptions and voltage variations	IEC/EN 61000-4-11	Class 3
harmonics and interharmonics	IEC/EN 61000-4-13	Class 3
Interference emission		IEC/EN 61000-6-3
high-frequency radiated	IEC/CISPR 22, EN 55022	Class B
high-frequency conducted	IEC/CISPR 22, EN 55022	Class B

Technical diagrams

Load limit curves

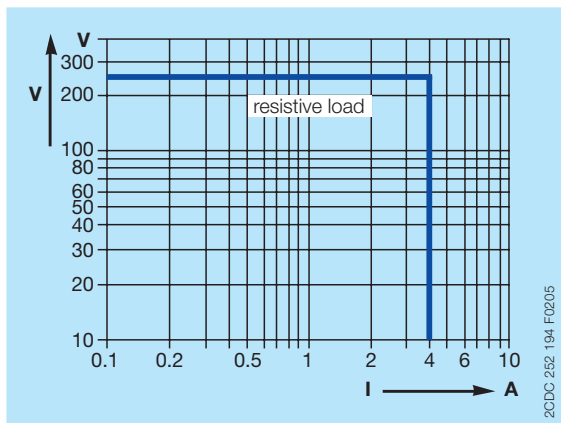

AC load (resistive)

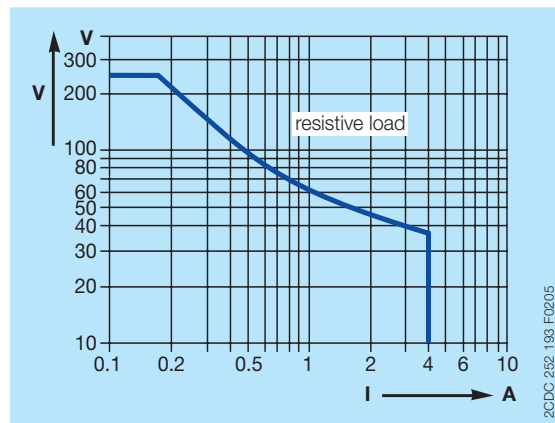

DC load (resistive)

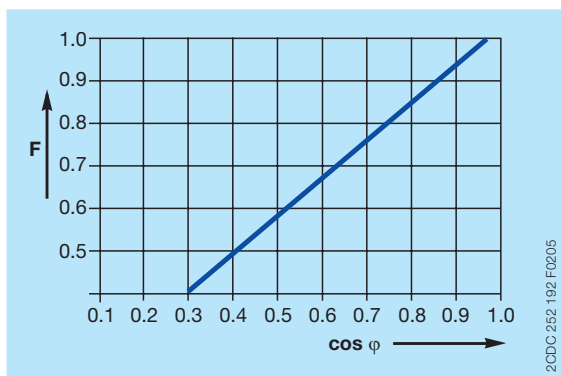

Derating factor F for inductive AC load

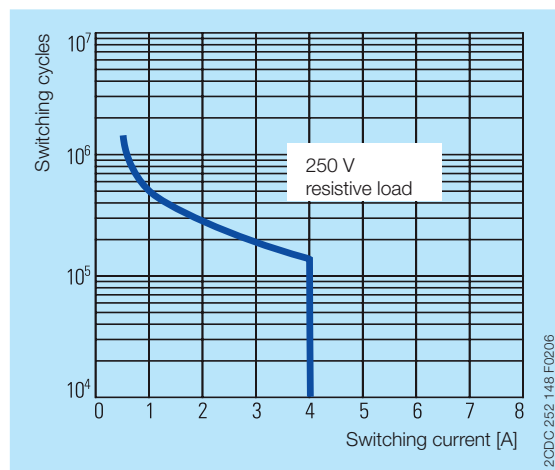

Contact lifetime

Dimensions

in **mm** and *inches*

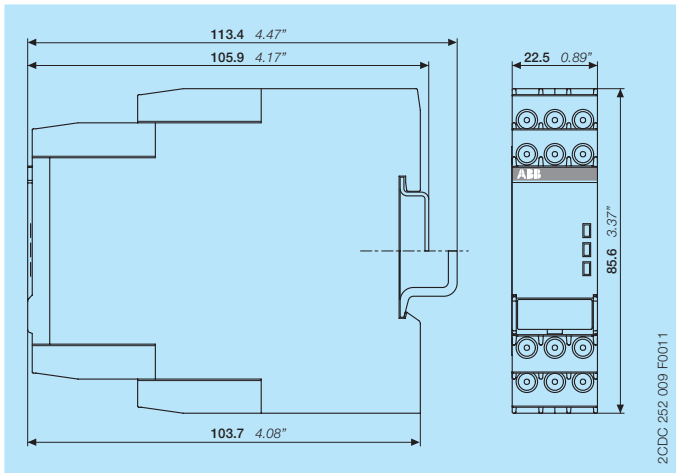

Accessories

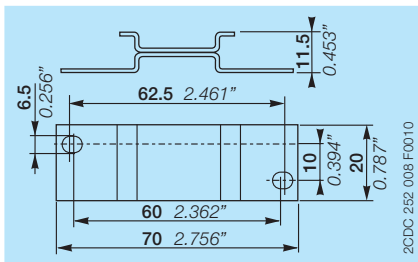

ADP.01 - Adapter for screw mounting

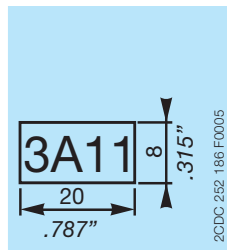

MAR.01 - Marker label

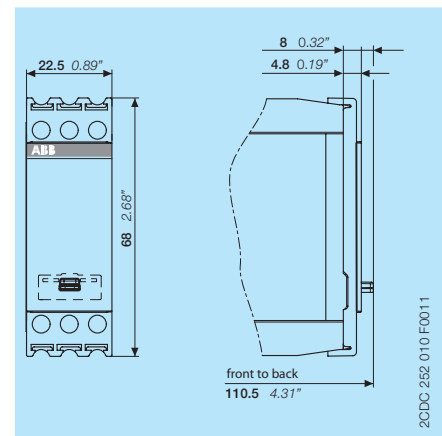

COV.11 - Sealable transparent cover

Further documentation

Document title	Document type	Document number
Electronic relays and controls	Catalog	2CDC 110 004 C02xx
CM-PAS, CM-PFS, CM-PSS, CM-PVS	Instruction manual	1SVC 630 510 M0000

You can find the documentation on the internet at www.abb.com/lowvoltage

-> Automation, control and protection -> Electronic relays and controls -> Measuring and monitoring relays.

CAD system files

You can find the CAD files for CAD systems at <http://abb-control-products.partcommunity.com>

-> Low Voltage Products & Systems -> Control Products -> Electronic Relays and Controls.

Contact us

ABB STOTZ-KONTAKT GmbH

P. O. Box 10 16 80
69006 Heidelberg, Germany
Phone: +49 (0) 6221 7 01-0
Fax: +49 (0) 6221 7 01-13 25
E-mail: info.desto@de.abb.com

You can find the address of your
local sales organisation on the
ABB home page
<http://www.abb.com/contacts>
-> Low Voltage Products

Note:

We reserve the right to make technical changes or modify the contents of this document without prior notice. With regard to purchase orders, the agreed particulars shall prevail. ABB AG does not accept any responsibility whatsoever for potential errors or possible lack of information in this document.

We reserve all rights in this document and in the subject matter and illustrations contained therein. Any reproduction, disclosure to third parties or utilization of its contents – in whole or in parts – is forbidden without prior written consent of ABB AG.

Copyright© 2017 ABB
All rights reserved